

End Mills Schaftfräser

www.lmt-tools.com

LMT•TOOLS
BELIN
FETTE
KIENINGER
ONSRUD

Imprint

Publisher: LMT Tools Global Operations GmbH & Co. KG, Vogesenstrasse 23, 77933 Lahr, Germany, Phone: +49 7821 943-0
Responsible according to the press law.: Norman Winter
Design: deckermedia GbR, Rostock
Printed by: Druckerei Weidner GmbH, Rostock

For readability reasons, the masculine form is used for personal designations and personal nouns for a general understanding. Corresponding terms apply to all genders for the purpose of equal treatment.

Impressum

Herausgeber: LMT Tools Global Operations GmbH & Co. KG, Vogesenstrasse 23, 77933 Lahr, Deutschland: +49 7821 943-0
Verantwortlich i. S. d. P.: Norman Winter
Gestaltung: deckermedia GbR, Rostock
Druck: Druckerei Weidner GmbH, Rostock

Aus Gründen der besseren Lesbarkeit wird bei Personenbezeichnungen und personenbezogenen Hauptwörtern für ein allgemeingültiges Verständnis die männliche Form verwendet. Entsprechende Begriffe gelten im Sinne der Gleichbehandlung grundsätzlich für alle Geschlechter.

© by LMT Tools Global Operations GmbH & Co. KG

This publication may not be reprinted in whole or part without our express permission. All right reserved. No rights may be derived from any errors in content or from typographical or typesetting errors. Diagrams, features and dimensions represent the current status on the date of issue of this catalog. We reserve the right to make technical changes.

The visual appearance of the products may not necessarily correspond to the actual appearance in all cases or in every detail.

Sources: Blue Planet Studio (iStock); André Brüggemann (Movingpix); Leonid Eremeychuk (Pond 5); kadmy (iStock); Korshenkov (Fotolia); LMT GmbH & Co. KG; Dominik Obertreis, Waldenweiler; studio thomas schmitz, Hamburg; Paul Siepker (iStock); Firma Work NC-Dental®; Maschinenbau GmbH, Bleckede; ZWP Zahnradwerk Pritzwalk GmbH, Pritzwalk
Nachdruck, auch auszugsweise, ist nur mit unserer Zustimmung gestattet. Alle Rechte vorbehalten. Irrtümer, Satz- oder Druckfehler berechtigen nicht zu irgendwelchen Ansprüchen. Abbildungen, Ausführungen und Maße entsprechen dem neuesten Stand bei Herausgabe dieses Kataloges. Technische Änderungen müssen vorbehalten sein.

Die bildliche Darstellung der Produkte muss nicht in jedem Falle und in allen Einzelheiten dem tatsächlichen Aussehen entsprechen.

Bildquellen: Blue Planet Studio (iStock); André Brüggemann (Movingpix); Leonid Eremeychuk (Pond 5); kadmy (iStock); Korshenkov (Fotolia); LMT GmbH & Co. KG; Dominik Obertreis, Waldenweiler; studio thomas schmitz, Hamburg; Paul Siepker (iStock); Firma Work NC-Dental®; Maschinenbau GmbH, Bleckede; ZWP Zahnradwerk Pritzwalk GmbH, Pritzwalk



2	The company Das Unternehmen
3	Worldwide presence Weltweite Präsenz
4	Industry solutions Branchenlösungen
5	Knowledge in theory and practice Wissen in Theorie und Praxis
6	Explanation LMT-Code Erklärung LMT-Code
7	The LMT cutting material key Der LMT Schneidstoffschlüssel
8	Tool guide Tool Guide

EASYMill

The universal end mill for all milling operations

Der Allrounder für alle Fräsoperationen



12

EASYMill

High Performance Cutter

Our series for the highest productivity requirements

Unsere Serie für höchste Anforderungen an Produktivität

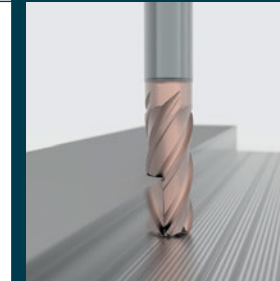

20

High Performance Cutter

High Feed Cutter

Our complete program for high feed milling

Unser Komplettdprogramm für das Hochvorschubfräsen

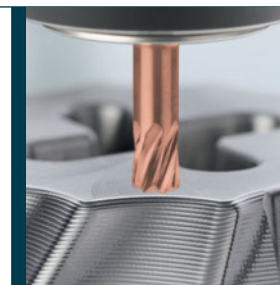

52

High Feed Cutter

High Speed Cutter

A new benchmark for surface quality and reliability

Ein neuer Standard für Oberflächenqualität und Zuverlässigkeit

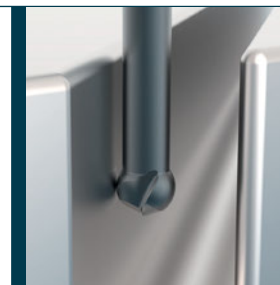

70

High Speed Cutter

Trochoidal Performance Cutter

The perfect solution for trochoidal milling

Die perfekte Lösung für trochoidales Fräsen



120

Trochoidal Performance Cutter

Micro Milling Cutter

Precision at its best

Präzision in Perfektion



126

Micro Milling Cutter

LMT Tools is one of the leading experts in the development and production of precision tools.

With its passionate commitment to precision, the company ensures that its customers in industry apply superior quality at the crucial interface between machine and workpiece.

With more than 1,000 employees worldwide, LMT Tools bundles its expertise in the brands LMT Fette, LMT Kieninger, LMT Onsrud and LMT Behn. The company's main product areas are milling & threading, rolling systems, gear cutting and advanced tools.

LMT Tools ist einer der führenden Experten für die Entwicklung und Produktion von Präzisionswerkzeugen.

Das Unternehmen sorgt mit seinem leidenschaftlichen Einsatz für Präzision dafür, dass seine Kunden in der Industrie an der entscheidenden Schnittstelle zwischen Maschine und Werkstück überlegene Qualität zum Einsatz bringen.

Mit weltweit mehr als 1.000 Mitarbeitenden bündelt LMT Tools die Kompetenzen in den Marken LMT Fette, LMT Kieninger, LMT Onsrud und LMT Behn. Dabei bedient das Unternehmen die Produktschwerpunkte Fräsen & Gewinden, Rollsysteme, Verzahnen und Advanced Tools.

Our core competences:

- Milling and Tapping
- Rolling systems
- Gear cutting
- Advanced Tools

Unsere Kernkompetenzen:

- Fräsen und Gewinden
- Rollsysteme
- Verzahnen
- Advanced Tools

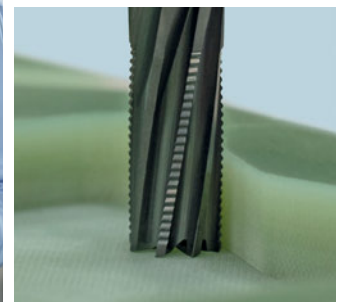
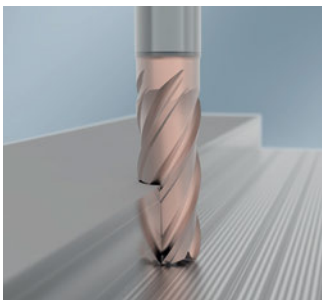



● **LMT Tools production sites:**

Germany: Lahr, Schwarzenbek
USA: Waukegan
India: Pune
China: Nanjing

● **LMT Tools Produktionsstandorte:**

Deutschland: Lahr, Schwarzenbek
USA: Waukegan
Indien: Pune
China: Nanjing

● **LMT Tools has its own sales representations in the following countries:**

Europe: Czech Republic, France, Germany, Italy, Romania, Spain, United Kingdom.

Americas: Brazil, Mexico, USA.

Asia-Pacific: China, India, Korea.

● **LMT Tools ist mit eigenen Vertriebsgesellschaften in folgenden Ländern vertreten:**

Europa: Deutschland, Frankreich, Italien, Rumänien, Spanien, Tschechische Republik, Vereinigtes Königreich.

Amerika: Brasilien, Mexiko, USA.

Asien-Pazifik: China, Indien, Korea.

We are committed to you worldwide!

Contact us and our experts: www.lmt-tools.com

Wir sind weltweit für Sie da!

Nehmen Sie Kontakt zu uns und unseren Experten auf:
www.lmt-tools.com

The key element of the services at LMT Tools is our eye for detail and passion for precision to help our customers implement their visions, ideas and needs.

We see precision tools as the key to bringing ideas to life. These ideas then go on to become market successes, driven forward by efficiency and innovative power.

The extensive product range combines the competence of the LMT Belin, LMT Fette, LMT Kieninger and LMT Onsrud brands. It offers perfect solutions for various applications in different industries:

- Transportation & Transmission: automotive, trucks, ships, railway, aerospace industry
- Stationary: cranes, wind energy, gear boxes and drives
- Mould & Die
- Pump and Valve
- General machining

Kern der Leistung von LMT Tools ist es, die Visionen, Ideen und Anforderungen unserer Kunden mit dem Blick fürs Detail und der Leidenschaft für Präzision umsetzen zu helfen.

Wir sehen Präzisionswerkzeuge als Schlüssel dazu, Ideen zum Leben zu erwecken. Und aus diesen Ideen mit Innovationskraft und Effizienz Markterfolge zu machen.

Mit unseren umfangreichen Produktprogramm bündeln wir die Kompetenzen der Marken LMT Belin, LMT Fette, LMT Kieninger und LMT Onsrud. Es bietet perfekte Lösungen für eine Vielzahl an Anwendungen in unterschiedlichen Industrien:

- Transport und Antriebe: Automobil, LKW, Schiffe, Schienenfahrzeuge, Luft- und Raumfahrt
- Stationar: Kräne, Windenergie, Getriebe und Antriebe
- Werkzeug & Formenbau
- Pumpen und Ventile
- Allgemeiner Maschinenbau



Our Academy is the central training and further education unit of the corporate group. At the LMT Tools Training Center, holistic knowledge in theory and practice is passed on to our employees and customers worldwide in order to quickly provide knowledge in response to continuous global market changes in products and production processes.

The training courses take place in online webinars or live training sessions on site and are conducted by experienced and specialized employees or by experts from industry and academia.

The program offers expert knowledge for our employees for existing products and processes and new products. With the necessary application knowledge about our tools we can optimally support the machining requirements of our customers.

The training offer for our customers and business partners includes tool demonstrations or seminars, tailor-made specifically to meet their application demands.

Unsere Academy ist die zentrale Schulungs- und Weiterbildungseinheit der Unternehmensgruppe. Im LMT Tools Training Center wird ganzheitliches Wissen in der Theorie und Praxis weltweit an unsere Mitarbeiter und Kunden weitergegeben, um so schnell auf kontinuierliche globale Marktveränderungen bei Produkten und Produktionsprozessen Wissen zu vermitteln.

Die Schulungen finden in Webinaren online oder in Live-Trainings vor Ort statt und werden von erfahrenen und spezialisierten Mitarbeitern oder auch von Experten aus Industrie und Wissenschaft durchgeführt.

Das Angebot für unsere Mitarbeiter umfasst Expertenwissen für bestehende Produkte und Verfahren und Neuprodukte. Dank aktuellem Anwendungswissen über unsere Werkzeuge können wir optimal die Bearbeitungsanforderungen unserer Kunden unterstützen.

Das Schulungsangebot für unsere Kunden und Geschäftspartner umfasst Werkzeugvorführungen oder Seminare, um speziell und maßgeschneidert auf ihre Anwendungssituationen einzugehen.



E	M	-	H	P	C	0	1	M	4	.	0	x	3	.	5	/	3	2	4	C	0	.	2	H	A	-	I
1			2			3		4		5		6				7		8	9	10		11		12			
1	EM = Schaftfräser End Mill																										
2	Typ Type																										
	HPC = High Performance Cutter																										
	HFC = High Feed Cutter																										
	HSC = High Speed Cutter																										
	TPC = Trochoidal Performance Cutter																										
	UMC = Universal Milling Cutter																										
	AMC = Aluminium Milling Cutter																										
	RMC = Radial Milling Cutter																										
	EMC = EASYMill																										
	CBC = Chip Breaker Cutter																										
3	01 = Generation Generation																										
4	Hauptanwendung Primary application																										
	P = Stahl Steel																										
	M = Rostfreier Stahl Stainless steel																										
	K = Gusseisen Cast iron																										
	N = Nichteisenmetalle Non-ferrous metals																										
	S = Hitzebeständige Legierungen Heat-resistant alloys																										
	H = Gehärteter Stahl Hardened steel																										
	U = Universal Universal																										
5	Schneidendurchmesser in mm (d ₁) Cutting diameter in mm (d ₁)																										
6	Schneidenlänge in mm (l ₂) Cutting length in mm (l ₂)																										
7	max. Nutzlänge in mm (l ₃) Effective length in mm (l ₃)																										
8	Zähnezahl (z) Number of teeth (z)																										
9	Stirngeometrie Front geometry																										
	C = Kantenschutzfase Edge protection chamfer																										
	R = Eckenradius Corner radius																										
	B = Kugelstirn Ball nose																										
	S = Gerade Stirn Straight corner																										
10	Eckenradius (r)/Kantenschutzfase (c) in mm Corner radius (r)/Edge protection chamfer (c) in mm																										
11	Schaftform Shank form																										
	HA = Zylindrischer Schaft Cylindrical shank DIN 6535 HA																										
	HB = Gerader Schaft Straight shank DIN 6535 HB																										
12	Innenkühlung Internal cooling																										

Erklärung LMT-Code Micro HScline
Explanation LMT-Code Micro HScline

E	M	-	M	I	C	0	1	P	0	0	5	x	0	1	5	/	0	2	2	0	2	B	0	0	2	5	
1			2			3		4		5		6				7		8	9	10							
1	EM = Schaftfräser End Mill																										
2	Typ Type																										
	MIC = Mikrofräser Micro cutter																										
3	01 = Generation Generation																										
4	Hauptanwendung Primary application																										
	P = Stahl Steel																										
	M = Rostfreier Stahl Stainless steel																										
	K = Gusseisen Cast iron																										
	N = Nichteisenmetalle Non-ferrous metals																										
	S = Hitzebeständige Legierungen Heat-resistant alloys																										
	H = Gehärteter Stahl Hardened steel																										
	U = Universal Universal																										
5	Schneidendurchmesser in mm (d ₁ = 1/10 mm) Cutting diameter in mm (d ₁ = 1/10 mm)																										
6	Schneidenlänge in mm (l ₂ = 1/10 mm) Cutting length in mm (l ₂ = 1/10 mm)																										
7	max. Nutzlänge in mm (l ₃ = 1/10 mm) Effective length in mm (l ₃ = 1/10 mm)																										
8	Zähnezahl (z) Number of teeth (z)																										
9	Stirngeometrie Front geometry																										
	C = Kantenschutzfase Edge protection chamfer																										
	R = Eckenradius Corner radius																										
	B = Kugelstirn Ball nose																										
	S = Gerade Stirn Straight corner																										
10	Eckenradius/Kugelkoppradius (r) in 1/100 mm Corner radius/Ball nose radius (r) in 1/100 mm																										

Für Schneidstoff- und Beschichtungssorten hat die LMT einen anwenderbezogenen Sortenschlüssel entwickelt. Hiermit wird es dem Anwender ermöglicht, gemäß seiner spezifischen Applikation immer den richtigen LMT Schneidstoff auszuwählen.

LMT has developed a user-oriented grades index for the new LMT cutting material and coating grades to ensure that users always select the correct LMT cutting material for their applications.

Die Empfehlung basiert auf dem international verwendeten ISO Schlüssel der Werkstückstoffe.

This recommendation is based on the internationally used ISO key for workpiece materials.

L C K P 3 0 M 1						
	1	2	3	4	5	6

1 Marke LMT LMT brand

2 **Schneidstoff Cutting material**

A	= HSS
B	= CBN
C	= Hartmetall, beschichtet Carbide, coated
D	= PKD PCD
E	= Monokristalliner Diamant Monocrystalline diamond
T	= Cermet
W	= Hartmetall, unbeschichtet Carbide, uncoated
X	= Keramik Ceramics

3 **Werkstückstoff (ISO 513 – Haupt- und Nebenanwendung)**
Workpiece material (ISO 513 – Primary and auxiliary application)

P	= Stahl Steel
M	= Rostfreier Stahl Stainless steel
K	= Gusseisen Cast iron
N	= Nichteisenmetalle Non-ferrous metals
S	= Hitzebeständige Legierungen Heat-resistant alloys
H	= Gehärteter Stahl Hardened steel

4 Zähigkeit (ISO 513)
Toughness (ISO 513)

5 **Bearbeitung Machining**

B	= Bohren Boring/Drilling
C	= Kurbelwellenfräsen Crankshaft
D	= Gewinden Tapping/Threading
F	= Reiben Reaming
G	= Einstechen Grooving
H	= Verzahnen High feed geometry
M	= Fräsen Milling
R	= Rollen Rolling
T	= Drehen Turning

6 Versionsnummer (wahlweise möglich)
Version number (optional)

Die bisherigen Sortenbezeichnungen behalten bis auf weiteres ihre Gültigkeit.

The previously used grade designations remain valid until further notice.

<p>Beispiel:</p> <p>LCK10M</p> <p>L – LMT</p> <p style="padding-left: 20px;">C – Hartmetall, beschichtet</p> <p style="padding-left: 40px;">K – Gusseisen</p> <p style="padding-left: 60px;">10 – Zähigkeit</p> <p style="padding-left: 80px;">M – Fräsen</p>	<p>Example:</p> <p>LCK10M</p> <p>L – LMT</p> <p style="padding-left: 20px;">C – Carbide, coated</p> <p style="padding-left: 40px;">K – Cast iron</p> <p style="padding-left: 60px;">10 – Toughness</p> <p style="padding-left: 80px;">M – Milling</p>
---	---

1. Wählen Sie Ihre Anwendung
Choose your application

- Eckfräsen
Corner milling
- Trochoidalfräsen
Trochoidal milling
- Eck-/Nutfräsen
Corner/Slot milling
- HSC Mikrofräser
HSC Micro cutters
- Kopierfräsen
Copying
- Hochvorschubfräsen
High feed milling

2. Wählen Sie das Anwendungsfeld/Materialfeld
für Ihre Anwendung aus

Choose your application area/material for your application

P	Stahl, Stahlguss, rostfreier Stahl, ferritisch und martensitisch Steel, cast steel, stainless steel, ferritic and martensitic
M	Rostfreier Stahl und Stahlguss, austenitisch und austenitisch/ferritisch Stainless steel and cast steel, austenitic and austenitic/ferritic
K	Grauguss, Sphäroguss, Temperguss Grey cast iron, cast iron with spheroidal graphite, malleable cast iron
N	Aluminium und andere Nichteisenmetalle, Kunststoffe, Graphit Aluminium and other non ferrous metals, plastic, graphite
S	Hochwärmefeste Stähle, Super- und Titanlegierungen High temperature alloys, super and titanium alloys
H	Gehärteter Stahl und Stahlguss Hardened steel and cast steel

3. Wählen Sie die von Ihnen benötigte Stirngeometrie,
Spiralwinkel, Länge sowie Zähnezahl

Choose your front geometry, helix angle and number of teeth

- Eckenradius (R)
Corner radius
- Hochvorschub (F)
High feed
- Kugelstirn (B)
Ball nose
- Kantenschutzfase (E)
Edge protection
- Gerade (S)
Straight corner

4. Für mehr Details gelangen Sie mit dem Seitenverweis
auf die entsprechende Katalogseite

For further details see the page reference for the corresponding catalog page

- Eckenausführung
Corner version
 - Hauptanwendung
First choice
- HPC01 Rougher 41/44M** 28
- für austenitische Stähle, NE-Metalle und Titan
for stainless steels, non-ferrous and titanium
- Ø 4-20 mm
z = 4
-
- 1 2

HPC Fräser High performance cutter				Hochvorschubfräsen High feed milling				Trochoidales Fräsen Trochoidal milling		Mikrofräsen Mikro milling				
P	EASYPill Schafffräser End mill Ø 3-20 mm z = 4	16 HPC01 Rougher 35/38P für hochlegierte Stähle und Guss for high carbon steel and cast iron Ø 1-20 mm z = 4	24 HPC01 Rougher 35/38 H für gehärtete Stähle ≤ 55 HRC for hard materials ≤ 55 HRC Ø 6-20 mm z = 4	36 HPC01 Rougher 33/35/37 UNI Vollnutfräser mit großem Spanraum für die universelle Anwendung Slot mill with large room for chips for universal applications Ø 4-20 mm z = 3	32 HFC01 Rougher P für hochlegierte Stähle for high alloy steels Ø 2-16 mm z = 4	55 HFC01 Rougher H für gehärtete Stähle bis 65 HRC for hardened steels up to 65 HRC Ø 4-20 mm z = 3	63 HFC01 Rougher UNI Universeller Hochvorschubfräser Universal high feed end mills Ø 1-20 mm z = 2	66 TPC 01 Rougher 45 P Schafffräser End mill Ø 6-20 mm z = 5	122 MIC 01 Toric-Finisher 30 U 3-schneidig, kurz 3 flute, short Ø 0,5-3 mm z = 2	128 MIC 01 Toric-Finisher 30 PH 2-schneidig, kurz/lang 2 flute, short/long Ø 0,3-2,5 mm z = 2	132 MIC 01 Ball-Nose-Finisher 30 PH Kugelpopf, kurz Ball nose, short Ø 0,5-3 mm z = 2	136 MIC 01 Ball-Nose-Finisher 30 PH mit Halsfreistellung with neck relief Ø 1-4 mm z = 2	137 MIC 01 Ball-Nose-Finisher 30 PH mit Halsfreistellung with neck relief Ø 0,3-3 mm z = 2	138 MIC 01 Ball-Nose-Finisher 30 PH mit Halsfreistellung with neck relief Ø 0,3-3 mm z = 2
M	EASYPill Schafffräser End mill Ø 3-20 mm z = 4	16 HPC01 Rougher 41/44M für austenitische Stähle, NE-Metalle und Titan for stainless steels, non-ferrous and titanium Ø 4-20 mm z = 4		32 HPC01 Rougher 33/35/37 UNI Vollnutfräser mit großem Spanraum für die universelle Anwendung Slot mill with large room for chips for universal applications Ø 4-20 mm z = 3	59 HFC01 Rougher M für austenitische Stähle for austenitic steels Ø 4-16 mm z = 4		66 HFC01 Rougher UNI Universeller Hochvorschubfräser Universal high feed end mills Ø 1-20 mm z = 2	66 TPC 01 Rougher 35 M Schafffräser End mill Ø 6-20 mm z = 5	123 MIC 01 Toric-Finisher 30 U 3-schneidig, kurz 3 flute, short Ø 0,5-3 mm z = 2					
K		24 HPC01 Rougher 35/38P für hochlegierte Stähle und Guss for high carbon steel and cast iron Ø 1-20 mm z = 4	36 HPC01 Rougher 35/38 H für gehärtete Stähle ≤ 55 HRC for hard materials ≤ 55 HRC Ø 6-20 mm z = 4	32 HPC01 Rougher 33/35/37 UNI Vollnutfräser mit großem Spanraum für die universelle Anwendung Slot mill with large room for chips for universal applications Ø 4-20 mm z = 3	55 HFC01 Rougher P für hochlegierte Stähle for high alloy steels Ø 2-16 mm z = 4	63 HFC01 Rougher H für gehärtete Stähle bis 65 HRC for hardened steels up to 65 HRC Ø 4-20 mm z = 3	66 HFC01 Rougher UNI Universeller Hochvorschubfräser Universal high feed end mills Ø 1-20 mm z = 2	66 TPC 01 Rougher 45 P Schafffräser End mill Ø 6-20 mm z = 5	122 MIC 01 Toric-Finisher 30 U 3-schneidig, kurz 3 flute, short Ø 0,5-3 mm z = 2	128	136 MIC 01 Ball-Nose-Finisher 30 PH Kugelpopf, kurz Ball nose, short Ø 0,5-3 mm z = 2			
N	AMC01 Finisher 37 N Schafffräser End mill Ø 3-20 mm z = 3	28 HPC01 Rougher 41/44M für austenitische Stähle, NE-Metalle und Titan for stainless steels, non-ferrous and titanium Ø 4-20 mm z = 4	49 Airline Schafffräser End mill Ø 4-25 mm z = 3	32 HPC01 Rougher 33/35/37 UNI Vollnutfräser mit großem Spanraum für die universelle Anwendung Slot mill with large room for chips for universal applications Ø 4-20 mm z = 3					128 MIC 01 Toric-Finisher 30 U 3-schneidig, kurz 3 flute, short Ø 0,5-3 mm z = 2					
S		28 HPC01 Rougher 41/44M für austenitische Stähle, NE-Metalle und Titan for stainless steels, non-ferrous and titanium Ø 4-20 mm z = 4		32 HPC01 Rougher 33/35/37 UNI Vollnutfräser mit großem Spanraum für die universelle Anwendung Slot mill with large room for chips for universal applications Ø 4-20 mm z = 3	59 HFC01 Rougher M für austenitische Stähle for austenitic steels Ø 4-16 mm z = 4			123 TPC 01 Rougher 35 M Schafffräser End mill Ø 6-20 mm z = 5						
H			36 HPC01 Rougher 35/38 H für gehärtete Stähle ≤ 55 HRC for hard materials ≤ 55 HRC Ø 6-20 mm z = 4		63 HFC01 Rougher H für gehärtete Stähle bis 65 HRC for hardened steels up to 65 HRC Ø 4-20 mm z = 3	66 HFC01 Rougher UNI Universeller Hochvorschubfräser Universal high feed end mills Ø 1-20 mm z = 2				132 MIC 01 Toric-Finisher 30 PH 2-schneidig, kurz/lang 2 flute, short/long Ø 0,3-2,5 mm z = 2	136 MIC 01 Ball-Nose-Finisher 30 PH Kugelpopf, kurz Ball nose, short Ø 0,5-3 mm z = 2	137 MIC 01 Ball-Nose-Finisher 30 PH mit Halsfreistellung with neck relief Ø 1-4 mm z = 2	138 MIC 01 Ball-Nose-Finisher 30 PH mit Halsfreistellung with neck relief Ø 0,3-3 mm z = 2	



EASY.

EASYMill

Der neue Allrounder

The New Universal Endmill

EASY.

Die Produktreihe für
höchste Effizienz und
universelle Anwendung.
Einfach in der Hand-
habung.

The product range for
highest efficiency and
universal application.
Easy to handle.

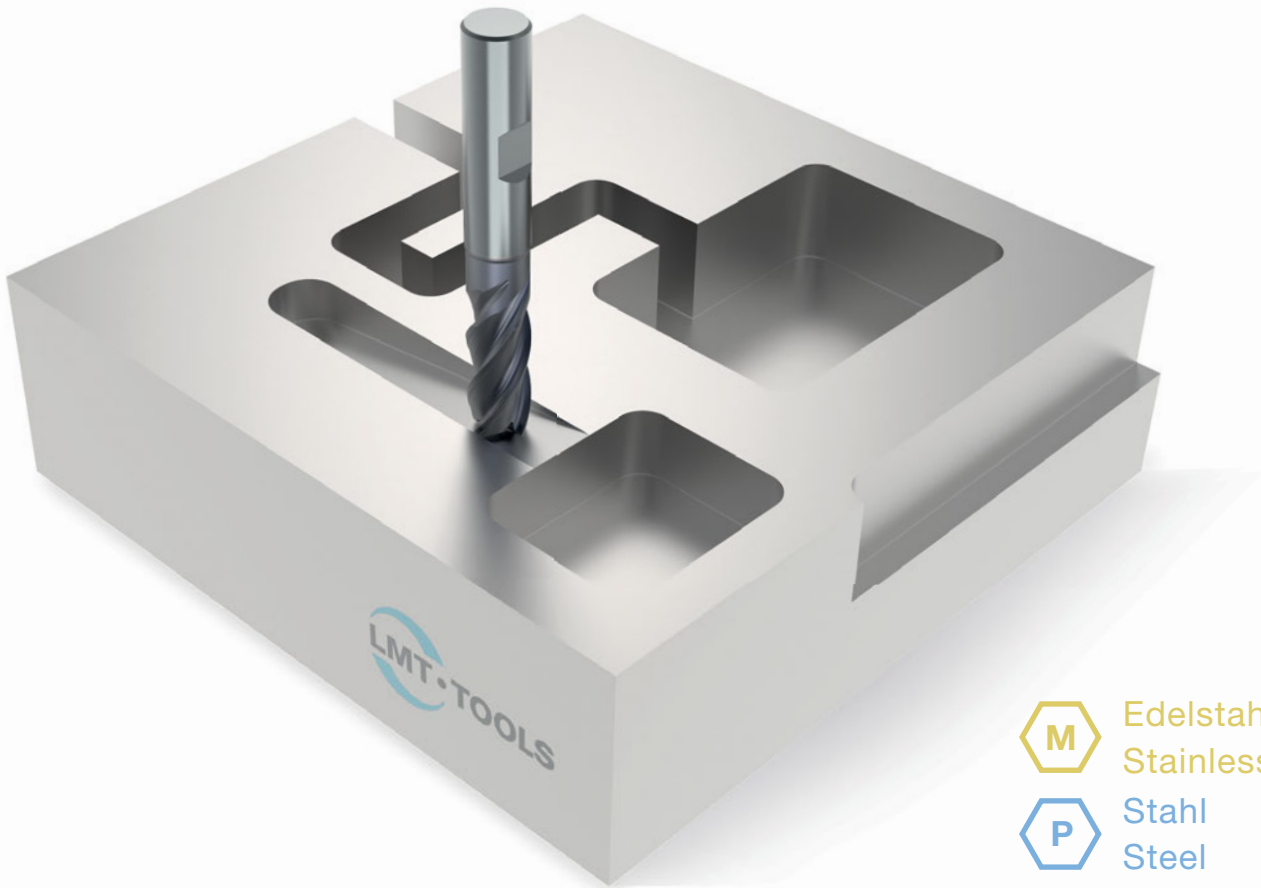

Ein Fräser, volle Flexibilität für alle Fräsoperationen One Milling Cutter, Full Flexibility For All Milling Operations

Beim Fräsen von kleinen und mittleren Serien ist große Flexibilität der Werkzeuge gefragt. Ob Schrupp- oder Schlichtbearbeitung, Nuten ins Volle, Rampen oder helikales Eintauchen. Mit dem EASYMill lassen sich alle gängigen Fräsoperationen perfekt abdecken. Mit einem Werkzeug in allen weich-zähen Stahl- und Edelstahl Werkstoffen prozesssicher und effizient fräsen.

With the EASYMill, all common milling operations can be perfectly covered, such as roughing, finishing, slotting, ramping or helical plunging. The EASYMill can efficiently be used in steel and stainless steel materials.



Eckfräsen
Corner milling



Nutenfräsen
Slot milling



Außenkonturfräsen
Contour milling



Taschenfräsen
Pocket milling



Zirkularfräsen
Circular milling

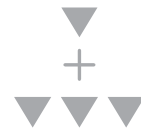

Schruppen und Schlichten
Roughing and finishing

Der Allrounder für niedrig- bis mittel- legierte und nichtrostende Stähle The Universal Endmill for Low-Alloy, Medium-Alloy and Stainless Steels

Mit seiner für Stahl und Edelstahl perfekt optimierten Geometrie fräst sich der EASYMill problemlos durch alle weich-zähen Werkstoffe. Schnittdruck und Zerspankräfte werden durch die ungleiche Drallsteigung effektiv reduziert. Dadurch ist der EASYMill auch bestens für den Einsatz an angetriebenen Werkzeugen auf Dreh-Fräsmaschinen qualifiziert.

Durch die angepasste, scharfe Schneidkante wird ein Aufkleben der Späne und dadurch ein Spänestau und Werkzeugbruch effektiv vermieden. So gelingt die prozesssichere Bearbeitung von weich-zähen Werkstoffen wie z. B. Bau- und Einsatzstählen und austenitischen Edelstählen (CrNi-Stähle). Dabei ist eine Zugfestigkeit von 300–900 N/mm² besonders geeignet.

With its geometry perfectly optimized for steel and stainless steel, the EASYMill cuts through all materials without any problems. Cutting pressure and cutting forces are effectively reduced by the unequal helix pitch. This makes the EASYMill ideally suited for use on turning-milling machines.

The adapted sharp cutting edge effectively prevents chip build up and tool breakage. This enables reliable machining of materials such as construction steels, case-hardened steels and austenitic stainless steels (CrNi steels). A malleable strength of 300–900 N/mm² is particularly suitable.

Merkmale:

Features:

Zylinderschaft – mit und ohne Spannfläche
Cylindrical shank – with and without clamping surface

Halsfreischliff
Neck relief

Beschichtung optimiert für Stahl und
nichtrostenden Stahl
Coating optimised for steel and stainless steel

Ungleiche Drallsteigung
Different helix angles

Bis Mitte schneidend
Cutting to the centre

Erhöhte Stabilität durch Verstärkung des „Rücken“
Increased stability through reinforcement of the „back“

Positive Schneidenausführung, für weiche und zähe Stähle der Klasse
ISO P, ISO M
Positive cutting edge geometry, for soft and tough steels of class
ISO P, ISO M

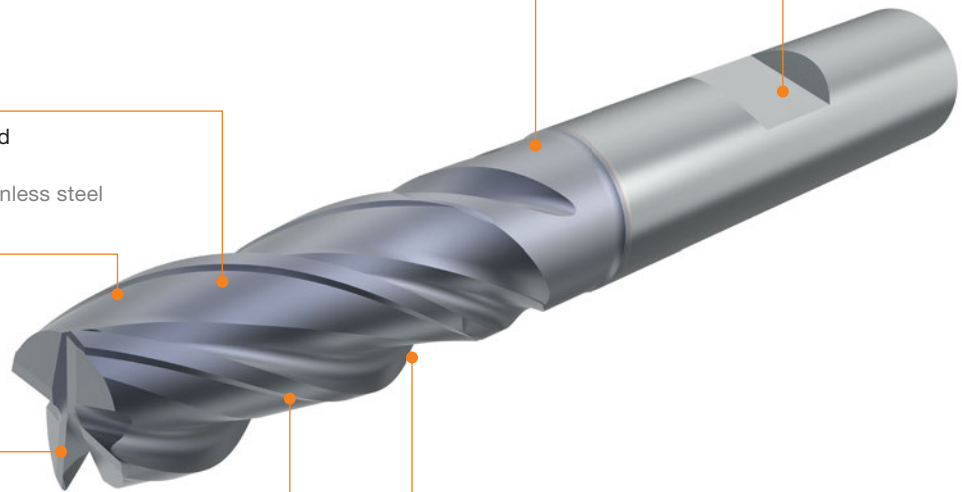





Katalog-Nr. Cat.-No.		EMC01-PM A				EMC01-PM B			
P		■						■	
M		■						■	
K									
N									
S									
H									
d ₁	l ₂	l ₁	l ₃	d ₂	z	Ident No.	LMT-Code	Ident No.	LMT-Code
3	6	54	9	6	4	7429329	EM-EMC01 PM3.0x6/9 4C0.075HA	7429338	EM-EMC01 PM3.0x6/9 4C0.075HB
4	8	54	12	6	4	7429330	EM-EMC01 PM4.0x8/12 4C0.1HA	7429339	EM-EMC01 PM4.0x8/12 4C0.1HB
5	10	54	15	6	4	7429331	EM-EMC01 PM5.0x10/15 4C0.15HA	7429340	EM-EMC01 PM5.0x10/15 4C0.15HB
6	13	57	21	6	4	7429332	EM-EMC01 PM6.0x13/21 4C0.2HA	7429341	EM-EMC01 PM6.0x13/21 4C0.2HB
8	19	63	27	8	4	7429333	EM-EMC01 PM8.0x19/27 4C0.2HA	7429342	EM-EMC01 PM8.0x19/27 4C0.2HB
10	22	72	32	10	4	7429334	EM-EMC01 PM10.0x22/32 4C0.2HA	7429343	EM-EMC01 PM10.0x22/32 4C0.2HB
12	26	83	38	12	4	7429335	EM-EMC01 PM12.0x26/38 4C0.2HA	7429344	EM-EMC01 PM12.0x26/38 4C0.2HB
16	32	92	44	16	4	7429336	EM-EMC01 PM16.0x32/44 4C0.3HA	7429345	EM-EMC01 PM16.0x32/44 4C0.3HB
20	38	104	54	20	4	7429337	EM-EMC01 PM20.0x38/54 4C0.3HA	7429346	EM-EMC01 PM20.0x38/54 4C0.3HB

■ = Hauptanwendung First choice
□ = Nebenanwendung Second choice

Schnittwertempfehlungen ab Seite 18
Cutting data recommendations starting page 18

Kantenschutzfase Edge protection chamfer	d ₁	b
	3	0,075
	4	0,1
	5	0,15
	6	0,2
	8	0,2
	10	0,2
	12	0,2
	16	0,3
	20	0,3

EASYMill
Schnittwertempfehlungen
Cutting data recommendations

Werkstoff	Material	Werkstoff-Nr. Material No.	R _m /UTS (N/ mm ²)	DIN Bezeichnung DIN Description	Kühlung Coolant	
P	Unlegierter Stahl Automatenstahl Niedrig legierter Stahl Einsatzstähle	Plain carbon steel	1.0715	-700	11SMn30	
		Free cutting steel	1.0570		S355J2+N	
		Low alloy steel	1.1206		C50E	
		Case hardening steel	1.7131		16MnCr5	
			1.7147		20MnCr5	
	Vergütungsstahl, mittelfest	Heat-treatment steel, medium strength	1.1191	-900	C45E	
			1.7219		26CrMo4	
			1.5752		15NiCr13	
			1.7225		42CrMo4	
			1.3505		100Cr6	
M	Rost- und säurebeständiger Stahl, austenitisch	Stainless steel, austenitic	-700	1.4301	X5CrNi18-10	
				1.4571	X6CrNiMoTi17-12-2	
				1.4404	X2CrNiMo17-12-2	
	Rost- und säurebeständiger Stahl, ferritisch, martensitisch	Stainless steel, ferritic, martensitic	-900	1.4122	X39CrMo17-1	
				1.4024	X15Cr13	
				1.4057	X17CrNi16-2	
				1.4512	X2CrTi12	



Trockenbearbeitung, Pressluftkühlung ist vorteilhaft
 Dry machining, air-blast cooling is advantageous



Nassbearbeitung, auf ausreichende Emulsionszuführung achten
 Wet machining, sufficient emulsion volume required

Berechnungsformeln und Vorschubkorrekturfaktoren
Calculation formulas and feed correction factors

Drehzahl
Speed n (min⁻¹):

$$n = \frac{v_c \cdot 1000}{\pi \cdot d_1}$$

Vorschubgeschwindigkeit
Feed rate v_f (mm/min):

$$v_f = f_z \cdot z \cdot n \cdot f_1$$

a_e = Schnittbreite Width of cut in mm
 a_p = Schnitttiefe Depth of cut in mm
 d₁ = Durchmesser Cutter diameter in mm
 f₁ = Korrekturfaktor für Correction factor v_f
 f_z = Vorschub pro Zahn Feed per tooth in mm
 n = Drehzahl Speed in min⁻¹
 v_f = Vorschubgeschwindigkeit Feed rate in mm/min
 z = Anzahl der Schneiden No. of teeth

Vorschubkorrektur Feed correction f ₁					
a _e	a _p	f ₁	a _e	a _p	f ₁
0,75 · d ₁	1 x d ₁	0,8	1 · d ₁	0,5 x d ₁	0,6
	1,5 x d ₁	0,7		1 x d ₁	0,5
	2 x d ₁ ¹⁾	0,6		2 x d ₁ ¹⁾	0,4

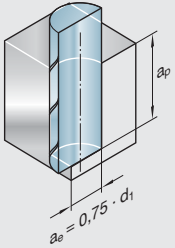

a_e = 0,75 · d₁

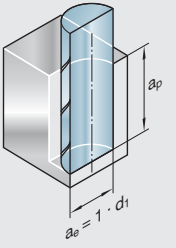

a_e = 1 · d₁

¹⁾ 1,8 x d₁ für Durchmesser for diameter 20

Schnittgeschwindigkeit Cutting speed v_c (m/min)	Fräserdurchmesser Cutting diameter (mm)									
	Vorschub pro Zahn Feed per tooth f_z (mm/z.) ¹⁾									
	Ø 3	Ø 4	Ø 5	Ø 6	Ø 8	Ø 10	Ø 12	Ø 16	Ø 20	
200	0,03	0,04	0,05	0,06	0,09	0,1	0,12	0,16	0,2	
160	0,025	0,03	0,035	0,045	0,065	0,075	0,09	0,12	0,15	
90	0,02	0,02	0,02	0,025	0,04	0,045	0,05	0,07	0,08	
80	0,015	0,015	0,015	0,02	0,03	0,04	0,045	0,06	0,07	

Die angegebenen Schnittwerte sind Startwerte und müssen auf die vorhandenen Bedingungen abgestimmt werden.
The cutting data above are starting values and must be adjusted to the existing conditions.

Tauchwinkel α für Rampen- und Helixfräsen Plunge angle α for ramping and helix milling	
Fräserdurchmesser Cutting diameter (mm)	Winkel Angle α
3-10	3°
12-20	5°

Anwendungsbeispiel Application example

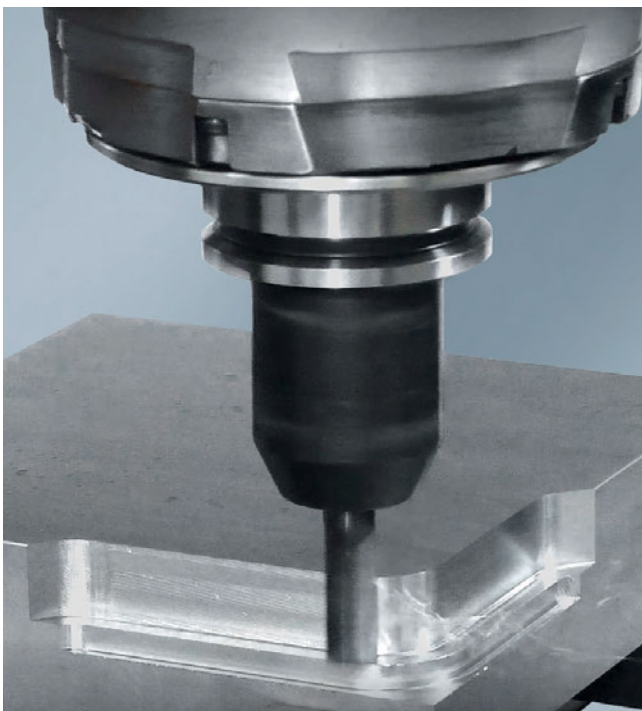

Kantenfräsen, schrappen Sidemilling, roughing

Werkzeug Tool:

EASYMill
 $d_1 = 12$ mm, $z = 4$

Werkstoff Material:

Vergütungsstahl Ck45 1.1191, $R_m = 700$ N/mm²
Heat-treatable steel 1.1191/1045, $R_m = 700$ N/mm²

Schnittwerte Cutting data:

$v_c = 180$ m/min
 $n = 4800$ min⁻¹
 $f_z = 0,12$ mm
 $h_m = 0,08$ mm
 $v_f = 2300$ mm/min
 $a_e = 6$ mm
 $a_p = 18$ mm

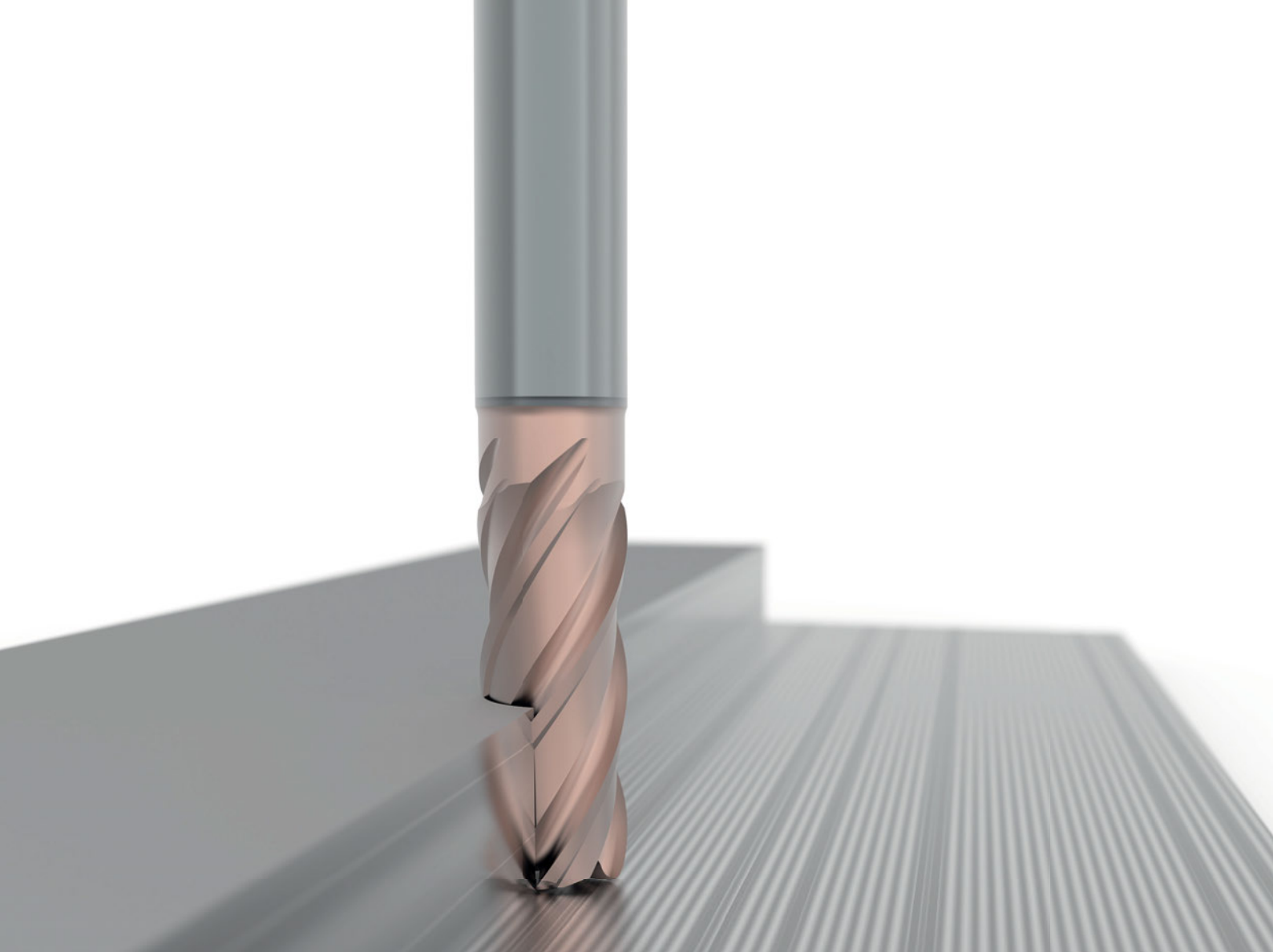

HPC – High Performance Cutter

Unsere Serie für höchste
Anforderungen an Produktivität
Our Series for the Highest
Productivity Requirements

Die neue HPC-Familie vereint die bewährten Werkzeugserien DHC Premium, DHC INOX Premium, DHC Slot und DHC Hardline unter einem Dach. Als Hochleistungsprogramm bietet sie dabei zahlreiche Vorteile für ein breites Anwendungsspektrum. Die verbesserte Technologie und erhöhte Produktivität liefern Anwender:innen einen deutlichen Performance-Vorteil. Die Bearbeitung mit HPC eignet sich ideal für das Trochoidal-, Kanten-, Eck- und Nutenfräsen sowie Rampen bis 0,5 x Durchmesser.

Durch die Optimierung der Produktionsprozesse und Verwendung modernster Beschichtungstechnologien konnten sowohl die Standzeiten als auch die Produktivität deutlich gesteigert werden. Mit ihren verschiedenen Schneidengängen und Durchmessern kann die HPC-Familie unterschiedlichsten Anforderungen entgegenreten.

Entdecken Sie die Vorteile der HPC-Familie und erleben Sie die volle Leistungsstärke von LMT Tools!

The new HPC family combines the proven tool series DHC Premium, DHC INOX Premium, DHC Slot and DHC Hardline under one roof. As a high-performance program, it offers numerous advantages for a wide range of applications. The improved technology and increased productivity provide users with a clear performance advantage. Machining with HPC is ideal for trochoidal, edge, corner and slot milling as well as ramping up to 0.5 x diameter.

By optimizing the production processes and using the latest coating technologies, both tool life and productivity have been significantly increased. With its various cutting edge lengths and diameters, the HPC family can meet a wide range of requirements.

Discover the advantages of the HPC family and experience the full performance of LMT Tools.

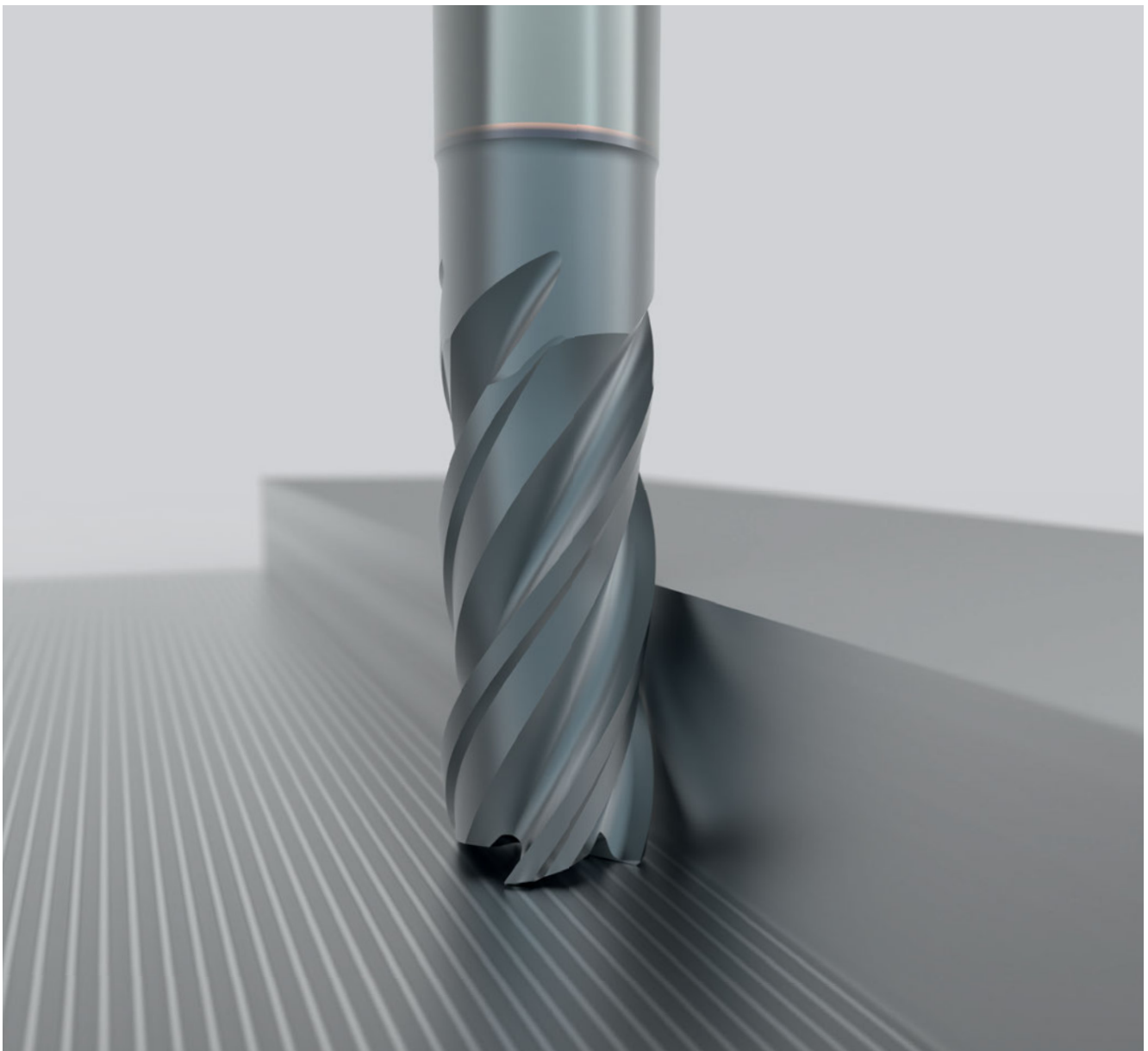

Die HPC-Familie ist für eine breite Anwendungspalette konzipiert: Von der Bearbeitung höher legierter Stähle, Guss- und austenitischer Werkstoffe bis hin zur Bearbeitung hochfester Werkstoffe bis 1600 N/mm² und gehärteter Stähle bis 55 HRC. Die ungleiche Teilung sorgt für höchste Laufruhe und Prozesssicherheit, während die sehr gute Oberflächenqualität der bearbeiteten Werkstücke einen weiteren Vorteil darstellt.

Ihre Vorteile:

- Sehr gute Oberflächenqualität der bearbeiteten Werkstücke
- Standzeiterhöhung von bis zu 70 % im Vergleich zu bewährten Produkten der Vorgängerfamilien

The HPC family is designed for a wide range of applications: From machining higher alloy steels, cast and austenitic materials to machining high-strength materials up to 1600 N/mm² and hardened steel up to 55 HRC. The uneven pitch ensures maximum smoothness and process reliability, while obtaining great surface quality of the machined workpieces.

Your advantages:

- Great surface quality of the machined workpieces
- Tool life increase of up to 70% compared to proven products of previous families

Merkmale:

Features:

Zylinderschaft: Mit und ohne Spannfläche,
sichere Drehmomentübertragung bzw. hohe Wuchtgüte
Cylindrical shank: With and without clamping surface,
Safe torque transmission and high balancing quality

Halsfreischliff
Neck relief

Mikroschneidkantenpräparation
Micro edge preparation









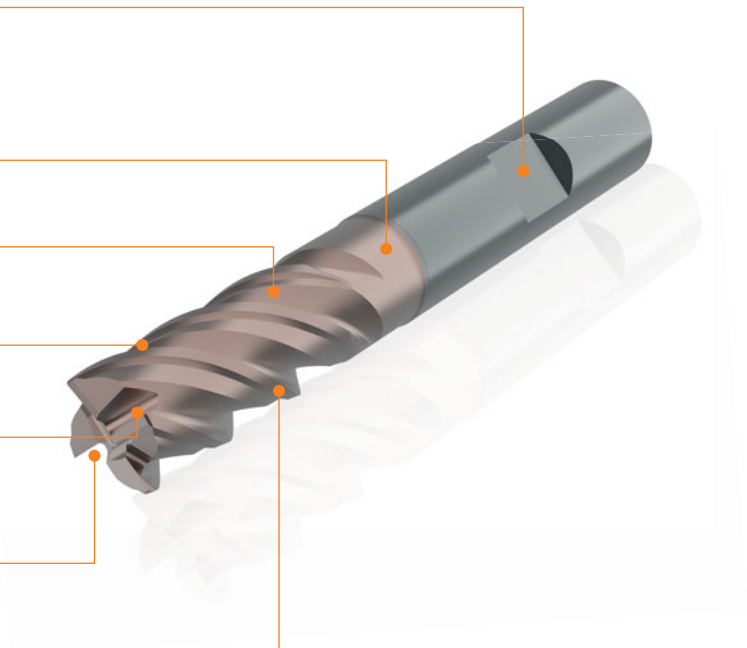



Besondere Laufruhe durch ungleiche Drallsteigung
Smooth running due to different helix angles

Über Mitte schneidend, auch zum Schräg-Eintauchen geeignet
Cross center cutting, also suitable for diagonal plunging

Optimierte Stirnauslückung für besseren Späneabtransport
Optimized flute clearance for better chip removal

Modernste Beschichtung
State-of-the-art coating

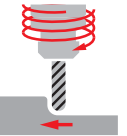

HPC P	HPC M	HPC H	HPC U
			
Für hochlegierte Stähle und Guss For high alloy steels and cast iron	Für austenitische Stähle, NE-Metalle und Titan For austenitic steels, non-ferrous metals and titanium	Für gehärtete Stähle ≤ 45 bis 55 HRC For hardened steels ≤ 45 to 55 HRC	Vollnutfräser mit großem Spanraum für die universelle Anwendung Full flute milling cutter with large chip removal space for universal application
P K	M S Nebenanwendung: N Second choice:	H P Nebenanwendung: K Second choice:	P M K N S
 Eckfräsen Corner milling	 Nutenfräsen Slot milling	 Außenkonturfräsen Contour milling	 Taschenfräsen Pocket milling
 Rampen Ramping	 Zirkularfräsen Circular milling	 Trochoidalfräsen Trochoidal milling	 Schruppen und Schlichten Roughing and finishing

Anwendungsbeispiel Application example



Schräg eintauchen Ramping

Werkzeug Tool:

HPC P
 $d_1 = 12 \text{ mm}$, $z = 4$

Werkstoff Material:

Vergütungsstahl 1.7225/42CrMo4, $R_m = 950 \text{ N/mm}^2$
Heat-treatment steel 1.7225/42CrMo4, $R_m = 950 \text{ N/mm}^2$

Schnittwerte Cutting data:

$v_c = 240 \text{ m/min}$
 $n = 6350 \text{ min}^{-1}$
 $f_z = 0,05 \text{ mm}$
 $v_f = 1300 \text{ mm/min}$
 $a_e = 12 \text{ mm}$
 $a_p = 8 \text{ mm}$
 $\alpha = 20^\circ$

HPC01 Rougher 35/38P
High Performance Cutter für hochlegierte Stähle und Guss
High Performance Cutter for high carbon steel and cast iron

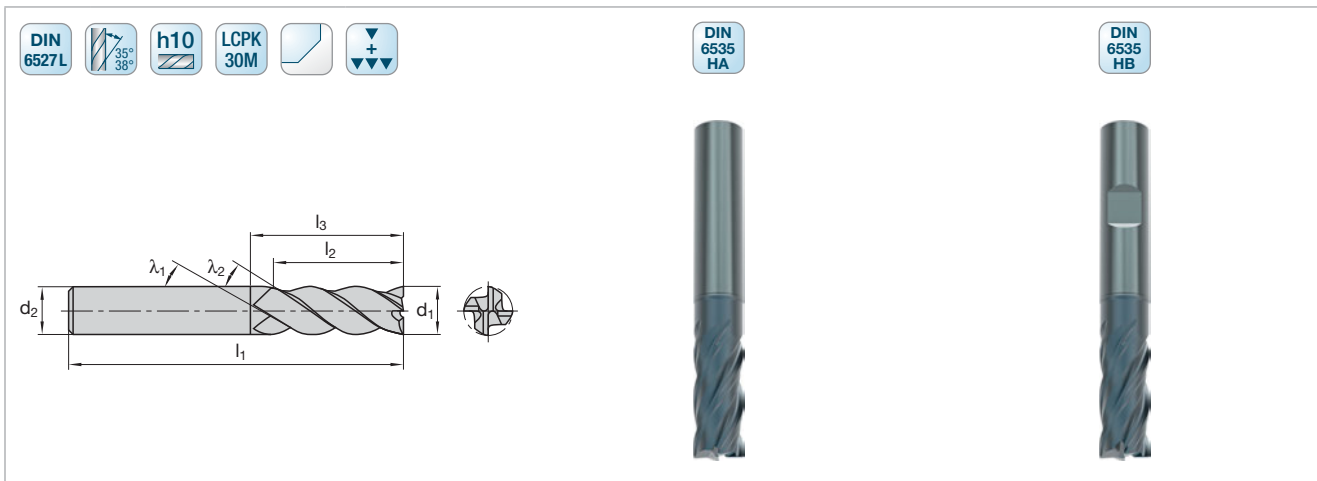

Katalog-Nr. Cat.-No.	HPC01-P-A	HPC01-P-B
P	■	■
M		
K	■	■
N		
S		
H		

d ₁	l ₂	l ₁	l ₃	d ₂	z	Ident No.	LMT-Code	Ident No.	LMT-Code
kurz short									
1	1,5	40	2	4	4	7426037	EM-HPC01 P1.0x1.5/2 4C0.025HA	-	-
2	3	40	4	4	4	7426038	EM-HPC01 P2.0x3/4 4C0.05HA	-	-
3	4	40	6	4	4	7426039	EM-HPC01 P3.0x4/6 4C0.075HA	-	-
4	5	54	8	6	4	7426069	EM-HPC01 P4.0x5/8 4C0.1HA	7426040	EM-HPC01 P4.0x5/8 4C0.1HB
5	6	54	10	6	4	7426070	EM-HPC01 P5.0x6/10 4C0.15HA	7426041	EM-HPC01 P5.0x6/10 4C0.15HB
6	7	54	16	6	4	7426071	EM-HPC01 P6.0x7/16 4C0.2HA	7426042	EM-HPC01 P6.0x7/16 4C0.2HB
8	9	58	20	8	4	7426072	EM-HPC01 P8.0x9/20 4C0.2HA	7426043	EM-HPC01 P8.0x9/20 4C0.2HB
10	11	66	24	10	4	7426073	EM-HPC01 P10.0x11/24 4C0.2HA	7426044	EM-HPC01 P10.0x11/24 4C0.2HB
12	12	73	26	12	4	7426074	EM-HPC01 P12.0x12/26 4C0.2HA	7426045	EM-HPC01 P12.0x12/26 4C0.2HB
14	14	75	28	14	4	7426075	EM-HPC01 P14.0x14/28 4C0.3HA	7426046	EM-HPC01 P14.0x14/28 4C0.3HB
16	16	82	32	16	4	7426076	EM-HPC01 P16.0x16/32 4C0.3HA	7426047	EM-HPC01 P16.0x16/32 4C0.3HB
18	18	84	34	18	4	7426077	EM-HPC01 P18.0x18/34 4C0.3HA	7426048	EM-HPC01 P18.0x18/34 4C0.3HB
20	20	92	40	20	4	7426078	EM-HPC01 P20.0x20/40 4C0.3HA	7426049	EM-HPC01 P20.0x20/40 4C0.3HB
lang long									
1	2,5	40	3	4	4	7426050	EM-HPC01 P1.0x2.5/3 4C0.025HA	-	-
2	4	40	6	4	4	7426051	EM-HPC01 P2.0x4/6 4C0.05HA	-	-
3	6	40	9	4	4	7426052	EM-HPC01 P3.0x6/9 4C0.075HA	-	-
4	8	54	12	6	4	7426079	EM-HPC01 P4.0x8/12 4C0.1HA	7426053	EM-HPC01 P4.0x8/12 4C0.1HB
5	10	54	15	6	4	7426080	EM-HPC01 P5.0x10/15 4C0.15HA	7426054	EM-HPC01 P5.0x10/15 4C0.15HB
6	13	57	21	6	4	7426081	EM-HPC01 P6.0x13/21 4C0.2HA	7426055	EM-HPC01 P6.0x13/21 4C0.2HB
8	19	63	27	8	4	7426082	EM-HPC01 P8.0x19/27 4C0.2HA	7426056	EM-HPC01 P8.0x19/27 4C0.2HB
10	22	72	32	10	4	7426083	EM-HPC01 P10.0x22/32 4C0.2HA	7426057	EM-HPC01 P10.0x22/32 4C0.2HB
12	26	83	38	12	4	7426084	EM-HPC01 P12.0x26/38 4C0.2HA	7426058	EM-HPC01 P12.0x26/38 4C0.2HB
14	26	83	38	14	4	7426085	EM-HPC01 P14.0x26/38 4C0.3HA	7426059	EM-HPC01 P14.0x26/38 4C0.3HB
16	32	92	44	16	4	7426086	EM-HPC01 P16.0x32/44 4C0.3HA	7426060	EM-HPC01 P16.0x32/44 4C0.3HB
18	32	92	44	18	4	7426087	EM-HPC01 P18.0x32/44 4C0.3HA	7426061	EM-HPC01 P18.0x32/44 4C0.3HB
20	38	104	54	20	4	7426088	EM-HPC01 P20.0x38/54 4C0.3HA	7426062	EM-HPC01 P20.0x38/54 4C0.3HB

- = Hauptanwendung First choice
- = Nebenanwendung Second choice

Schnittwertempfehlungen ab Seite 26
 Cutting data recommendations starting page 26

Kantenschutzfase Edge protection chamfer	d ₁	b
	1	0,025
	2	0,05
	3	0,075
	4	0,1
	5	0,15
	6-12	0,2
	14-20	0,3

HPC01 Rougher 35/38P
High Performance Cutter für hochlegierte Stähle und Guss
High Performance Cutter for high carbon steel and cast iron

DIN 6527L h10 LCPK 30M						DIN 6535 HA		DIN 6535 HB	
Katalog-Nr. Cat.-No.						HPC01-P-A		HPC01-P-B	
P						■		■	
M									
K						■		■	
N									
S									
H									
d₁	l₂	l₁	l₃	d₂	z	Ident No.	LMT-Code	Ident No.	LMT-Code
extra lang extra long									
6	9	65	29	6	4	7426089	EM-HPC01 P6.0x9/29 4C0.2HA	7426063	EM-HPC01 P6.0x9/29 4C0.2HB
8	12	75	39	8	4	7426090	EM-HPC01 P8.0x12/39 4C0.2HA	7426064	EM-HPC01 P8.0x12/39 4C0.2HB
10	15	80	40	10	4	7426091	EM-HPC01 P10.0x15/40 4C0.2HA	7426065	EM-HPC01 P10.0x15/40 4C0.2HB
12	18	93	48	12	4	7426092	EM-HPC01 P12.0x18/48 4C0.2HA	7426066	EM-HPC01 P12.0x18/48 4C0.2HB
16	24	108	60	16	4	7426093	EM-HPC01 P16.0x24/60 4C0.3HA	7426067	EM-HPC01 P16.0x24/60 4C0.3HB
20	30	126	76	20	4	7426094	EM-HPC01 P20.0x30/76 4C0.3HA	7426068	EM-HPC01 P20.0x30/76 4C0.3HB

■ = Hauptanwendung First choice
 □ = Nebenanwendung Second choice

Schnittwertempfehlungen ab Seite 26
 Cutting data recommendations starting page 26

Kantenschutzfase Edge protection chamfer	d₁	b
	1	0,025
	2	0,05
	3	0,075
	4	0,1
	5	0,15
	6-12	0,2
	14-20	0,3

HPC01 Rougher 35/38P
Schnittwertempfehlungen
Cutting data recommendations

Werkstoff	Material	Werkstoff-Nr. Material No.	DIN Bezeichnung Alt DIN Description Old	R _m /UTS (N/mm ²)	DIN Bezeichnung Neu DIN Description New	
P	Unlegierter Baustahl + Automatenstahl	1.0570	St52-3	-700	S355J2G3	
		1.1730	C45	-800	C45U	
		1.0715	9SMn28	-700	11SMn30	
		1.1191	Ck45	500-950	C45E	
		1.7219	26CrMo4		26CrMo4-2	
	Vergütungsstahl, mittelfest	Heat-treatment steel, medium strength	1.7225	42CrMo4	500-950	42CrMo4
			1.8159	51CrV4		51CrV4
	Stahlguss	Cast steel	1.0416	GS40	-950	GS40
	Einsatzstahl	Case hardening steel	1.7131	16MnCr5	-950	16MnCr5
	Rost- und säurebe- ständiger Stahl, ferritisch, martensitisch	Stainless steel, ferritic, martensitic	1.4006	X10Cr13	500-950	X12Cr13
			1.4104	X12CrMoS17		X14CrMoS17
			1.4122	X35CrMo17		X39CrMo17-1
	Vergütungsstahl, hochfest	Heat-treatment steel, high strength	1.7225	42CrMo4	950-1400	42CrMo4
	1.6580	30CrNiMo8	30CrNiMo8			
	Nitrierstahl, vergütet	Nitriding steel, heat treated	1.8504	34CrAl6	950-1400	34CrAl6
			1.2344	X40CrMoV5.1	-900	X40CrMoV5-1
	Werkzeugstahl	Tool steel	1.2379	X155CrVMo12 1	240-350 HB	X153CrMoV12-1
1.2080			X210Cr12	X210Cr12		
1.2343			X38CrMoV5 1	950-1400	X37CrMoV5-1	
1.2358			60CrMoV18-5	850-1000	60CrMoV18-5	
1.2714			55NiCrMoV7	1100-1350	55NiCrMoV7	
1.2311			40CrMnMo7	-1100	40CrMnMo7	
1.2312			40CrMnNiMoS8.6	-1150	40CrMnNiMoS8-6	
1.2316			X38CrMo16	-1100	X38CrMo16	
1.2738			45CrMnNiMo8.6.4	950-1150	45CrMnNiMo8-6-4	
K	Grauguss	Grey cast iron	0.6025	GG25	100-400 (120-260 HB)	EN-GJI-250
	Legierter Grauguss	Alloyed grey cast iron	0.6678	GGL-NiCr35 2	150-250 (160-230 HB)	EN-GJLA-XNiCr35-2
	Sphäroguss	Nodular cast iron	0.7060	GGG60	400-800	EN-GJS-600-3
			0.7070	GGG70L	(120-310 HB)	EN-GJS-700-2U
	Temperguss	Malleable cast iron	0.8155	GTS55	350-700 (150-280 HB)	EN-GJMB-550-4

Berechnungsformeln und Vorschubkorrekturfaktoren
Calculation formulas and feed correction factors

Drehzahl Speed n (min ⁻¹): $n = \frac{v_c \cdot 1000}{\pi \cdot d_1}$	Vorschubkorrektur Feed correction f ₁				
	a _e	a _p	HPC01-P kurz short	HPC01-P lang long	HPC01-P extra lang ³⁾ extra long ³⁾
Vorschubgeschwindigkeit Feed rate v _f (mm/min): $v_f = f_z \cdot z \cdot n \cdot f_1$	0,1 · d ₁	1 x d ₁	2,4	2,2	1,6
		1,5 x d ₁	-	2	1,5
	0,25 · d ₁	2 x d ₁ ²⁾	-	1,6	-
		1 x d ₁	2,1	1,6	1,1
		1,5 x d ₁	-	1,4	1
	0,5 · d ₁	2 x d ₁ ²⁾	-	1,2	-
1 x d ₁		1,6	1,2	0,7	
1,5 x d ₁		-	1	0,6	
0,75 · d ₁	2 x d ₁ ²⁾	-	0,8	-	
	1 x d ₁	1,1	0,8	0,5	
	1,5 x d ₁	-	0,7	0,4	
1 · d ₁ ¹⁾	2 x d ₁ ²⁾	-	0,6	-	
	0,5 x d ₁	0,8	0,6	0,5	
	1 x d ₁	-	0,5	0,4	
		2 x d ₁ ²⁾	-	0,4	-

¹⁾ Für Durchmesser 1 bis 3: In langer Ausführung und a_e = d₁ sollte a_p 0,5 x d₁ nicht überschreiten
 For diameter 1 to 3: long version and a_e = d₁ should not cross over a_p 0.5 x d₁

²⁾ 1,8 x d₁ für Durchmesser 14, 18, 20
 1.8 x d₁ for diameter 14, 18, 20

³⁾ Für extra lange Werkzeuge v_c ggf. um 20 % reduzieren
 Reduce extra long tools cutting speed by 20 %

Kühlung Coolant	Schnitt- geschwindigkeit Cutting speed v_c (m/min)	Fräserdurchmesser Cutting diameter (mm)										
		Vorschub pro Zahn Feed per tooth f_z (mm/z.)										
		1 ¹⁾	2 ¹⁾	3 ¹⁾	4	5	6	8	10	12	14–16	18–20
☀️ 💧	230–275	0,008	0,016	0,025	0,05	0,06	0,07	0,10	0,12	0,14	0,19	0,24
	230–275	0,008	0,016	0,025	0,05	0,06	0,07	0,10	0,12	0,14	0,19	0,24
	200–240	0,008	0,014	0,02	0,04	0,06	0,07	0,09	0,11	0,13	0,18	0,22
	200–240	0,008	0,014	0,02	0,04	0,06	0,07	0,09	0,11	0,13	0,18	0,22
	160–200	0,008	0,014	0,02	0,04	0,06	0,07	0,09	0,11	0,13	0,18	0,22
	120–150	0,008	0,014	0,02	0,04	0,05	0,06	0,08	0,10	0,11	0,15	0,19
	140–180	0,008	0,014	0,02	0,04	0,05	0,06	0,08	0,10	0,11	0,15	0,19
	140–180	0,008	0,014	0,02	0,04	0,05	0,06	0,08	0,10	0,11	0,15	0,19
	110–140	0,005	0,013	0,02	0,03	0,04	0,05	0,07	0,09	0,10	0,14	0,17
	100–120	0,005	0,013	0,02	0,03	0,04	0,05	0,07	0,09	0,10	0,14	0,17
100–120	0,005	0,013	0,02	0,03	0,04	0,05	0,06	0,08	0,10	0,13	0,16	
☀️ 💧	180–220	0,012	0,025	0,04	0,06	0,08	0,09	0,12	0,15	0,18	0,22	0,28
	160–180	0,011	0,021	0,03	0,06	0,07	0,08	0,11	0,13	0,16	0,20	0,26
	150–180	0,01	0,02	0,03	0,05	0,06	0,07	0,10	0,12	0,14	0,19	0,24
	120–150	0,01	0,018	0,025	0,05	0,06	0,07	0,10	0,12	0,14	0,19	0,24

Die angegebenen Schnittwerte sind Startwerte und müssen auf die vorhandenen Bedingungen abgestimmt werden.
The cutting data above are starting values and must be adjusted to the existing conditions.

☀️ Trockenbearbeitung, Pressluftkühlung ist vorteilhaft
Dry machining, air-blast cooling is advantageous

💧 Nassbearbeitung, auf ausreichende Emulsionszuführung achten
Wet machining, sufficient emulsion volume required

Merkmale des HPC01-P Features of the HPC01-P

**Stabile Schneidkante mit Mikro-
schneidkantenpräparation für
gesteigerte Prozesssicherheit**
Stable cutting edge with micro cut-
ting edge preparation for increased
process reliability



**Stirnlückenausführung in Radius-
form für verbesserte Spanabfuhr**
Front cutting edge cavity design
in radius form for improved chip
removal



**Kontinuierlich veränderte Schneiden-
teilung für schwingungsarmes Fräsen
bei hohen Vorschüben**
Continuously variable cutting edge
pitch for low-vibration milling with
high feeds

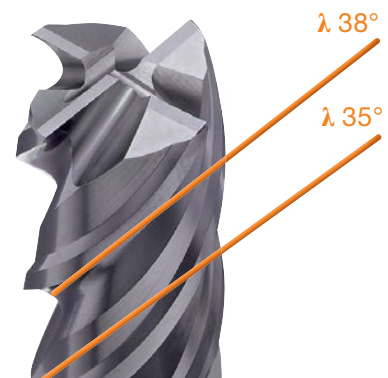

HPC01 Rougher 41/44M
High Performance Cutter für austenitische Stähle, NE-Metalle und Titan
High Performance Cutter for stainless steels, non-ferrous and titanium

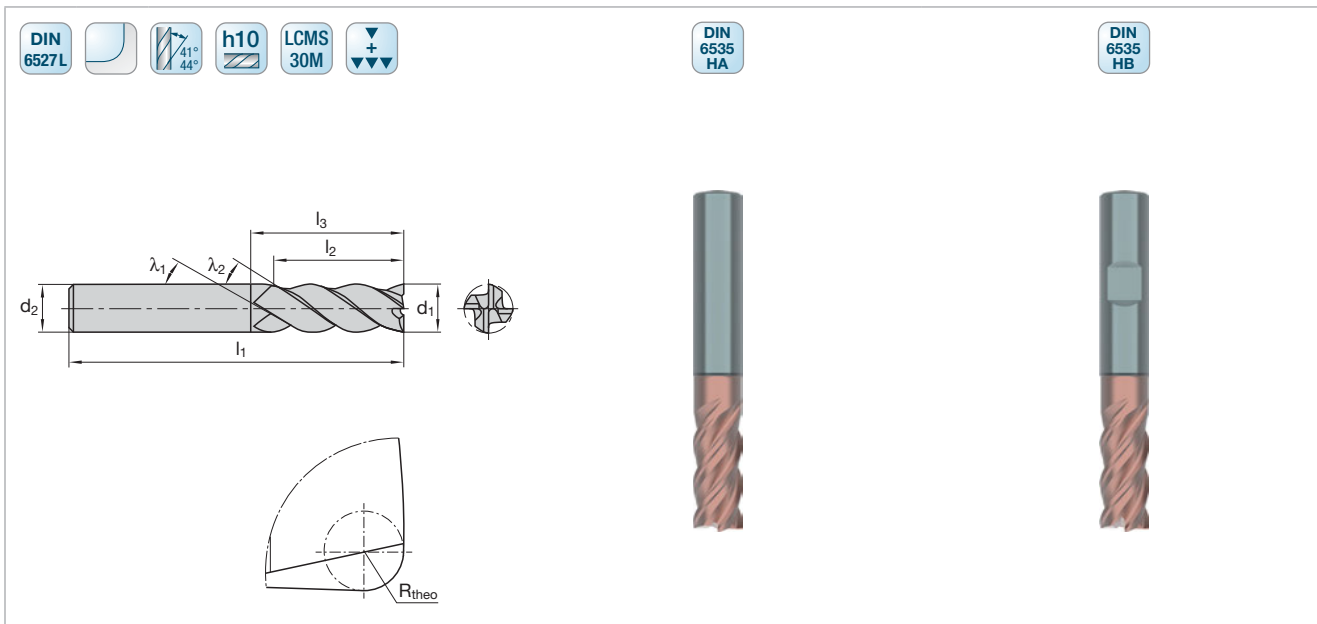

Katalog-Nr. Cat.-No.							HPC01-M-A		HPC01-M-B	
P										
M							■			■
K										
N							□			□
S							■			■
H										
d ₁	l ₂	l ₁	l ₃	d ₂	R _{theo} (+ 0,05)	z	Ident No.	LMT-Code	Ident No.	LMT-Code
kurz short										
4	5	54	8	6	0,15	4	7426779	EM-HPC01 M4.0x5/8 4R0.15HA	7426788	EM-HPC01 M4.0x5/8 4R0.15HB
5	6	54	10	6	0,2	4	7426780	EM-HPC01 M5.0x6/10 4R0.2HA	7426789	EM-HPC01 M5.0x6/10 4R0.2HB
6	7	54	16	6	0,3	4	7426781	EM-HPC01 M6.0x7/16 4R0.3HA	7426790	EM-HPC01 M6.0x7/16 4R0.3HB
8	9	58	20	8	0,3	4	7426782	EM-HPC01 M8.0x9/20 4R0.3HA	7426791	EM-HPC01 M8.0x9/20 4R0.3HB
10	11	66	24	10	0,3	4	7426783	EM-HPC01 M10.0x11/24 4R0.3HA	7426792	EM-HPC01 M10.0x11/24 4R0.3HB
12	12	73	26	12	0,3	4	7426784	EM-HPC01 M12.0x12/26 4R0.3HA	7426793	EM-HPC01 M12.0x12/26 4R0.3HB
14	14	75	28	14	0,4	4	7426785	EM-HPC01 M14.0x14/28 4R0.4HA	7432295	EM-HPC01 M14.0x14/28 4R0.4HB
16	16	82	32	16	0,4	4	7426786	EM-HPC01 M16.0x16/32 4R0.4HA	7426794	EM-HPC01 M16.0x16/32 4R0.4HB
18	18	84	34	18	0,4	4	7432294	EM-HPC01 M18.0x18/34 4R0.4HA	7432296	EM-HPC01 M18.0x18/34 4R0.4HB
20	20	92	40	20	0,4	4	7426787	EM-HPC01 M20.0x20/40 4R0.4HA	7426795	EM-HPC01 M20.0x20/40 4R0.4HB
lang long										
4	8	54	12	6	0,15	4	7426796	EM-HPC01 M4.0x8/12 4R0.15HA	7426805	EM-HPC01 M4.0x8/12 4R0.15HB
5	10	54	15	6	0,2	4	7426797	EM-HPC01 M5.0x10/15 4R0.2HA	7426806	EM-HPC01 M5.0x10/15 4R0.2HB
6	13	57	21	6	0,3	4	7426798	EM-HPC01 M6.0x13/21 4R0.3HA	7426807	EM-HPC01 M6.0x13/21 4R0.3HB
8	19	63	27	8	0,3	4	7426799	EM-HPC01 M8.0x19/27 4R0.3HA	7426808	EM-HPC01 M8.0x19/27 4R0.3HB
10	22	72	32	10	0,3	4	7426800	EM-HPC01 M10.0x22/32 4R0.3HA	7426809	EM-HPC01 M10.0x22/32 4R0.3HB
12	26	83	38	12	0,3	4	7426801	EM-HPC01 M12.0x26/38 4R0.3HA	7426810	EM-HPC01 M12.0x26/38 4R0.3HB
14	26	83	38	14	0,4	4	7426802	EM-HPC01 M14.0x26/38 4R0.4HA	7432298	EM-HPC01 M14.0x26/38 4R0.4HB
16	32	92	44	16	0,4	4	7426803	EM-HPC01 M16.0x32/44 4R0.4HA	7426811	EM-HPC01 M16.0x32/44 4R0.4HB
18	32	92	44	18	0,4	4	7432297	EM-HPC01 M18.0x32/44 4R0.4HA	7432299	EM-HPC01 M18.0x32/44 4R0.4HB
20	38	104	54	20	0,4	4	7426804	EM-HPC01 M20.0x38/54 4R0.4HA	7426812	EM-HPC01 M20.0x38/54 4R0.4HB

Schnittwertempfehlungen ab Seite 30
 Cutting data recommendations starting page 30

■ = Hauptanwendung First choice
 □ = Nebenanwendung Second choice

HPC01 Rougher 41/44M
High Performance Cutter für austenitische Stähle, NE-Metalle und Titan
High Performance Cutter for stainless steels, non-ferrous and titanium

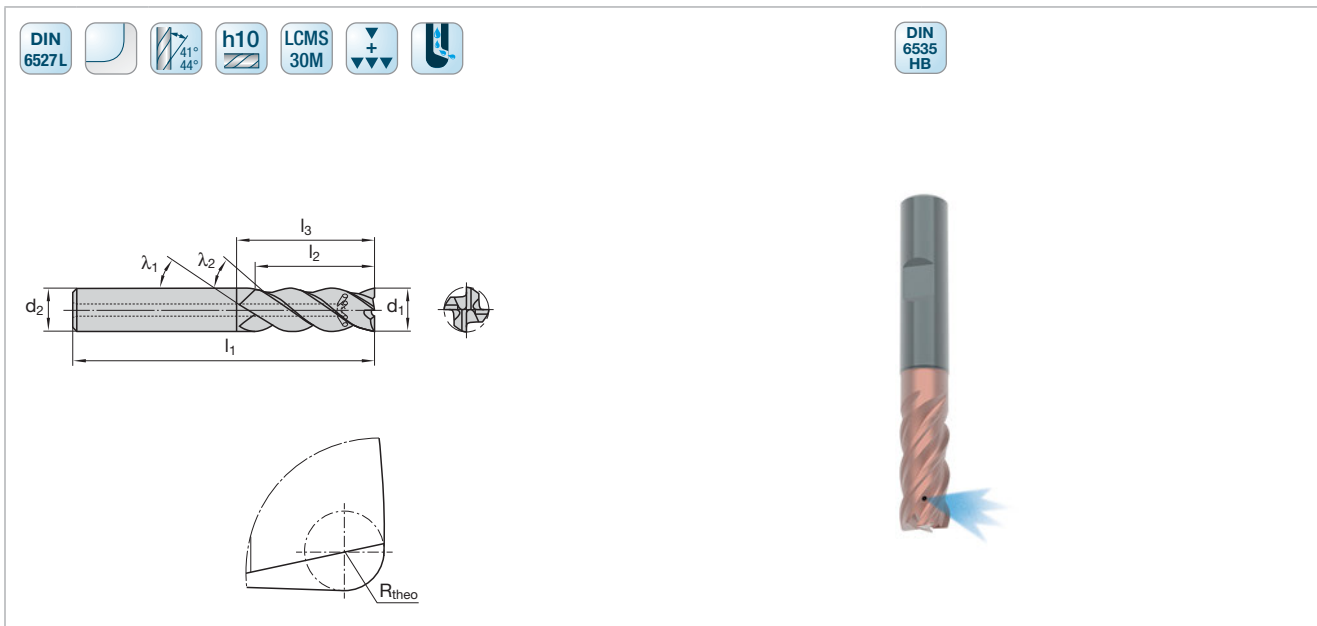

Katalog-Nr. Cat.-No.							HPC01-M-B		
P									
M								■	
K									
N								■	
S								■	
H									
d ₁	l ₂	l ₁	l ₃	d ₂	R _{theo} (+ 0,05)	z	Ident No.	LMT-Code	
lang long									
6	13	57	21	6	0,3	4	7426813	EM-HPC01 M6.0x13/21 4R0.3HB-I	
8	19	63	27	8	0,3	4	7426814	EM-HPC01 M8.0x19/27 4R0.3HB-I	
10	22	72	32	10	0,3	4	7426815	EM-HPC01 M10.0x22/32 4R0.3HB-I	
12	26	83	38	12	0,3	4	7426816	EM-HPC01 M12.0x26/38 4R0.3HB-I	
16	32	92	44	16	0,4	4	7426817	EM-HPC01 M16.0x32/44 4R0.4HB-I	
20	38	104	54	20	0,4	4	7426818	EM-HPC01 M20.0x38/54 4R0.4HB-I	

Schnittwertempfehlungen ab Seite 30
 Cutting data recommendations starting page 30

■ = Hauptanwendung First choice
 □ = Nebenanwendung Second choice

HPC01 Rougher 41/44M

Schnittwertempfehlungen

Cutting data recommendations

Werkstoff	Material	Werkstoff-Nr. Material No.	DIN Bezeichnung Alt DIN Description Old	R _m /UTS (N/mm ²)	DIN Bezeichnung Neu DIN Description New
M Rost- und säurebeständiger Stahl, austenitisch Rost- und säurebeständiger Stahl, ferritisch, martensitisch Rost- und säurebeständiger Stahl, martensitisch aushärtbar	Stainless steel, austenitic	1.4301	X2CrNiMo17-12-2	500-950	X5CrNiMo18-10 X2CrNiMo17-12-2 X10CrNiMoTi18
		1.4404	X6CrNiMoTi17-12-2		
		1.4571	X10CrNiMoTi18		
	Stainless steel, ferritic, martensitic	1.4024	X15Cr13	500-950	X15Cr13 X17CrNi16-2 X35CrMo17
		1.4057	X17CrNi16-2		
		1.4122	X35CrMo17		
Stainless steel, martensitic steel	1.2709	X3NiCoMoTi18-9-5	800-1000	X3NiCoMoTi18-9-5 X5CrNiCuNb16-4 X7CrNiAl17-7	
	1.4542	X5CrNiCuNb16-4			
	1.4568	X7CrNiAl17-7			
N Aluminium-Legierungen, kurzspanend Kupfer-Legierungen, kurzspanend	Aluminium alloys, short chipping Copper alloys, short chipping	3.2581	G-AISI12	-400	G-IGK-AISI12
		2.0402	MS58	-500	CuZn40Pb2
S Titan-Legierungen, mittelfest Titan-Legierungen, hochfest Nickelbasis-Legierungen, mittelfest Nickelbasis-Legierungen, hochwarmfest	Titanium alloys, medium strength	3.7164	TiAl6V4	-950	Ti6AlV4 TiAl5Sn2-5
		3.7115	TiAl5Sn2,5		
	Titanium alloys, high strength	3.7174	TiAl6Sn2	900-1400	TiAl6V6Sn2
	Nickel based alloys, medium strength	2.4670	NiCr12Al6MoNb	-950	NiCr12Al6MoNb
		2.4668	NiCr19Fe19NbMo		
Heat resistant nickel based alloys, high strength	2.4668	NiCr19Fe19NbMo	900-1400	Inconel 718 NiCr19Fe19Nb5Mo3	

Die angegebenen Schnittwerte sind Startwerte und müssen auf die vorhandenen Bedingungen abgestimmt werden.
The cutting data indicated are starting values and must be adjusted to the prevailing conditions.

Berechnungsformeln und Vorschubkorrekturfaktoren

Calculation formula and feed correction factors

Drehzahl Speed n (min ⁻¹): $n = \frac{v_c \cdot 1000}{\pi \cdot d_1}$	Vorschubkorrektur Feed correction f ₁				v _c
	a _e	a _p	HPC01-M kurz short f ₁	HPC01-M lang long f ₁	
Vorschubgeschwindigkeit Feed rate v _f (mm/min): $v_f = f_z \cdot z \cdot n \cdot f_1$	0,1 · d ₁	1 x d ₁	2	1,8	um 30 % erhöhen increase by 30 %
		1,5 x d ₁ ¹⁾	-	1,7	
		2 x d ₁ ¹⁾	-	1,6	
	0,25 · d ₁	1 x d ₁	1,7	1,4	
		1,5 x d ₁	-	1,3	
		2 x d ₁ ¹⁾	-	1,2	
	0,5 · d ₁	1 x d ₁	1,3	1,1	
		1,5 x d ₁	-	1	
		2 x d ₁ ¹⁾	-	0,8	
	0,75 · d ₁	1 x d ₁	1	0,8	
		1,5 x d ₁	-	0,7	
	1 · d ₁	0,75 x d ₁	0,7	0,6	um 20 % reduzieren reduce by 20 %

¹⁾ 1,8 x d₁ für Durchmesser 14, 18, 20
1.8 x d₁ for diameter 14, 18, 20

Kühlung Coolant	Schnitt- geschwindigkeit Cutting speed v_c (m/min)	Fräserdurchmesser Cutting diameter (mm)		
		Vorschub pro Zahn Feed per tooth f_z (mm/z.)		
		4-6	8-12	14-20
	100-110	0,03	0,05	0,08
	100	0,04	0,07	0,11
	120-130	0,03	0,07	0,10
	300-330	0,06	0,12	0,19
	250-275	0,05	0,10	0,16
	80-90	0,03	0,06	0,10
	80-90	0,03	0,06	0,10
	60-65	0,02	0,04	0,06
	40-45	0,03	0,06	0,10
	30-35	0,02	0,04	0,06

 Nassbearbeitung, auf ausreichende Emulsionszuführung achten
Wet machining, sufficient emulsion volume required

HPC01 Rougher 41/44M

Merkmale und Vorteile

Features and benefits

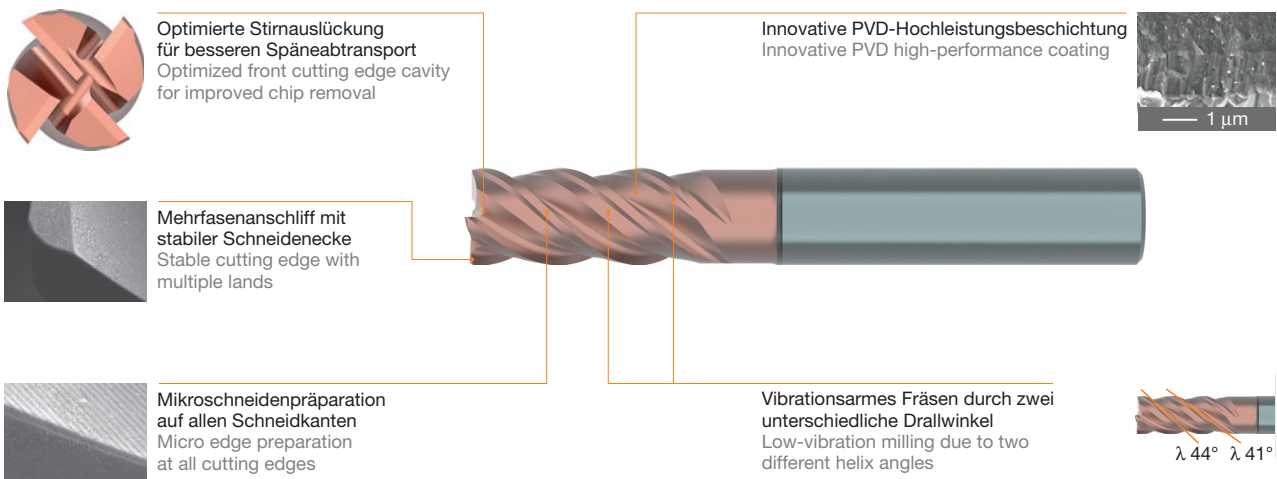

Vorteile:

- Min. 10 % höheres Zeitspanvolumen gegenüber der bisherigen Ausführung
- Gesteigerte Prozesssicherheit durch stabile Schneidkanten
- Schwingungsarm auf Grund unterschiedlicher Drallsteigung
- Multifunktional einsetzbar – Schruppen und Schlichten, Nuten fräsen und Ramping mit dem gleichen Werkzeug
- Gute Oberflächenqualität
- Großes Zeitspanvolumen, hohe Vorschübe
- Hohe Standzeit

Benefits:

- At least 10 % more machining volume compared with the previous
- Increased process reliability thanks to stable cutting edges
- Low vibration due to variable helix angles
- Multi functional use – roughing and finishing, cutting of slots and ramping – all with one tool
- Excellent surface quality
- Large machining volume from high feed rates
- Longer tool life

HPC01 Rougher 33/35/37 UNI

High Performance Vollnutfräser mit großem Spanraum für die universelle Anwendung

High Performance slot mill with large room for chips for universal applications

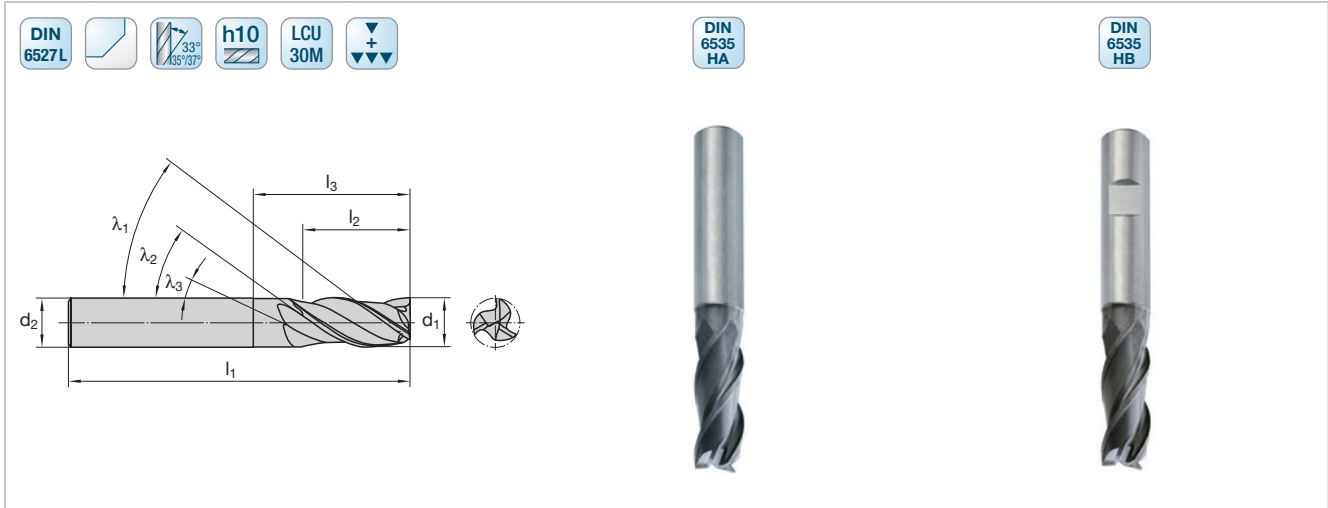

Katalog-Nr. Cat.-No.		HPC01-U-A				HPC01-U-B			
P		■				■			
M		■				■			
K		■				■			
N		■				■			
S		■				■			
H									
d ₁	l ₂	l ₁	l ₃	d ₂	z	Ident No.	LMT-Code	Ident No.	LMT-Code
kurz short									
4	5	54	8	6	3	7432428	EM-HPC01 U4.0x5/8 3C0.1HA	7432436	EM-HPC01 U4.0x5/8 3C0.1HB
5	6	54	10	6	3	7432429	EM-HPC01 U5.0x6/10 3C0.15HA	7432437	EM-HPC01 U5.0x6/10 3C0.15HB
6	7	54	12	6	3	7432430	EM-HPC01 U6.0x7/12 3C0.2HA	7432438	EM-HPC01 U6.0x7/12 3C0.2HB
8	9	58	16	8	3	7432431	EM-HPC01 U8.0x9/16 3C0.2HA	7432439	EM-HPC01 U8.0x9/16 3C0.2HB
10	11	66	20	10	3	7432432	EM-HPC01 U10.0x11/20 3C0.2HA	7432440	EM-HPC01 U10.0x11/20 3C0.2HB
12	12	73	24	12	3	7432433	EM-HPC01 U12.0x12/24 3C0.2HA	7432441	EM-HPC01 U12.0x12/24 3C0.2HB
16	16	82	32	16	3	7432434	EM-HPC01 U16.0x16/32 3C0.3HA	7432442	EM-HPC01 U16.0x16/32 3C0.3HB
20	20	92	40	20	3	7432435	EM-HPC01 U20.0x20/40 3C0.3HA	7432443	EM-HPC01 U20.0x20/40 3C0.3HB
lang long									
4	8	54	12	6	3	7432444	EM-HPC01 U4.0x8/12 3C0.1HA	7432452	EM-HPC01 U4.0x8/12 3C0.1HB
5	10	54	15	6	3	7432445	EM-HPC01 U5.0x10/15 3C0.15HA	7432453	EM-HPC01 U5.0x10/15 3C0.15HB
6	13	57	21	6	3	7432446	EM-HPC01 U6.0x13/21 3C0.2HA	7432454	EM-HPC01 U6.0x13/21 3C0.2HB
8	19	63	27	8	3	7432447	EM-HPC01 U8.0x19/27 3C0.2HA	7432455	EM-HPC01 U8.0x19/27 3C0.2HB
10	22	72	32	10	3	7432448	EM-HPC01 U10.0x22/32 3C0.2HA	7432456	EM-HPC01 U10.0x22/32 3C0.2HB
12	26	83	38	12	3	7432449	EM-HPC01 U12.0x26/38 3C0.2HA	7432457	EM-HPC01 U12.0x26/38 3C0.2HB
16	32	92	44	16	3	7432450	EM-HPC01 U16.0x32/44 3C0.3HA	7432458	EM-HPC01 U16.0x32/44 3C0.3HB
20	38	104	54	20	3	7432451	EM-HPC01 U20.0x38/54 3C0.3HA	7432459	EM-HPC01 U20.0x38/54 3C0.3HB

■ = Hauptanwendung First choice
□ = Nebenanwendung Second choice

Schnittwertempfehlungen ab Seite 34
Cutting data recommendations starting page 34

Kantenschutzfase Edge protection chamfer	d ₁	b
	4	0,1
	5	0,15
	6-12	0,2
	14-20	0,3

HPC01 Rougher 33/35/37 UNI
Vorschubempfehlungen
Feed recommendations

Der HPC01 Rougher 33/35/37 UNI ist ein 3-schneidiger Fräser. Durch seine großen Spanräume und die sehr gute Spanabfuhr ist er optimal für das Nutenfräsen geeignet. Jede Schneide hat einen anderen Drallwinkel (33°/35°/37°).

Neben dem gesamten Spektrum für rost- und säurebeständige Stähle ist der HPC01 Rougher 33/35/37 UNI auch in der gesamten Stahlbearbeitung einsetzbar.

The HPC01 Rougher 33/35/37 UNI is a 3-flute end mill. It is ideally suited to slot milling work thanks to its large chip spaces and its extremely good chip removal. Each cutting edge has a different helix angle (33°/35°/37°).

Besides the entire range for stainless and acid-resistant steels, the HPC01 Rougher 33/35/37 UNI is also suitable for all steel applications.



Berechnungsformeln und Vorschubkorrekturfaktoren
Calculation formula and feed correction factors

Drehzahl Speed n (min ⁻¹): $n = \frac{v_c \cdot 1000}{\pi \cdot d_1}$	Vorschubkorrektur Feed correction f ₁				v _c	
	a _e	a _p	HPC01-U kurz short f ₁	HPC01-U lang long f ₁		
Vorschubgeschwindigkeit Feed rate v _f (mm/min): $v_f = f_z \cdot Z \cdot n \cdot f_1$	0,1 · d ₁	1 x d ₁	2	1,8	um 30 % erhöhen increase by 30 %	
		1,5 x d ₁	–	1,7		
		2 x d ₁ ¹⁾	–	1,6		
	0,25 · d ₁	1 x d ₁	2	1,4		
		1,5 x d ₁	–	1,3		
		2 x d ₁ ¹⁾	–	1,2		
	0,5 · d ₁	1 x d ₁	1,3	1,1		
		1,5 x d ₁	–	1		
		2 x d ₁ ¹⁾	–	0,8		
	0,75 · d ₁	1 x d ₁	1	0,8		
		1,5 x d ₁	–	0,7		
		2 x d ₁	–	0,6		
1 · d ₁	0,5 x d ₁	0,9	0,8	um 20 % reduzieren reduce by 20 %		
	1 x d ₁	0,8	0,7			
	1,5 x d ₁	–	0,6			















¹⁾ 1,8 x d₁ für Durchmesser 14, 18, 20
 1,8 x d₁ for diameter 14, 18, 20

HPC01 Rougher 33/35/37 UNI
Schnittwertempfehlungen
Cutting data recommendations

Werkstoff	Material	Werkstoff-Nr. Material No.	DIN Bezeichnung Alt DIN Description Old	R_m/UTS (N/mm²)	DIN Bezeichnung Neu DIN Description New	
P	Unlegierter Baustahl + Automatenstahl	1.0570	St52-3	-700	S355J2G3	
		1.1730	C45	-800	C45U	
		1.0715	9SMn28	-700	11SMn30	
		1.1191	Ck45	500-950	C45E	
	Vergütungsstahl, mittelfest	Heat-treatment steel, medium strength	1.7225	42CrMo4	500-950	42CrMo4
			1.8159	51CrV4		51CrV4
	Stahlguss	Cast steel	1.0416	GS40	-950	GS40
	Einsatzstahl	Case hardening steel	1.7131	16MnCr5	-950	16MnCr5
	Rost- und säurebeständiger Stahl, ferritisch, martensitisch	Stainless steel, ferritic, martensitic	1.4006	X10Cr13	500-950	X12Cr13
			1.4104	X12CrMoS17		X14CrMoS17
			1.4122	X35CrMo17		X39CrMo17-1
	Vergütungsstahl, hochfest	Heat-treatment steel, high strength	1.7225	42CrMo4	950-1400	42CrMo4
			1.6580	30CrNiMo8		30CrNiMo8
	Nitrierstahl, vergütet	Nitriding steel, heat treated	1.8504	34CrAl6	950-1400	34CrAl6
			1.2344	X40CrMoV5.1	-900	X40CrMoV5-1
Werkzeugstahl	Tool steel	1.2343	X38CrMoV5 1	950-1400	X37CrMoV5-1	
		1.2379	X155CrVMo12 1	-950	X153CrMoV12-1	
		1.2316	X38CrMo16	-1100	X38CrMo16	
		1.2358	60CrMoV18-5	850-1000	60CrMoV18-5	
		1.2080	X210Cr12	950-1400	X210Cr12	
		1.2714	55NiCrMoV7	1100-1350	55NiCrMoV7	
		1.2311	40CrMnMo7	-1100	40CrMnMo7	
		1.2312	40CrMnNiMoS8.6	-1150	40CrMnNiMoS8-6	
1.2738	45CrMnNiMo8.6.4	950-1150	45CrMnNiMo8-6-4			
M	Rost- und säurebeständiger Stahl, austenitisch	1.4301	X2CrNiMo17-12-2	500-950	X5CrNiMo18-10	
		1.4404	X6CrNiMoTi17-12-2		X2CrNiMo17-12-2	
		1.4571	X10CrNiMoTi18		X10CrNiMoTi18	
Rost- und säurebeständiger Stahl, martensitisch aushärtbar	Stainless steel, martensitic steel	1.2709	X3NiCoMoTi18-9-5	800-1000	X3NiCoMoTi18-9-5	
		1.4542	X5CrNiCuNb16-4		X5CrNiCuNb16-4	
		1.4568	X7CrNiAl17-7		X7CrNiAl17-7	
K	Grauguss	Grey cast iron	0.6025	GG25	100-400 (120-260 HB)	EN-GJL-250
	Legierter Grauguss	Alloyed grey cast iron	0.6678	GGL-NiCr35 2	150-250 (160-230 HB)	EN-GJLA-XNiCr35-2
	Sphäroguss	Nodular cast iron	0.7060	GGG60	400-800	EN-GJS-600-3
			0.7070	GGG70L	(120-310 HB)	EN-GJS-700-2U
Temperguss	Malleable cast iron	0.8155	GTS55	350-700 (150-280 HB)	EN-GJMB-550-4	
N	Aluminium-Legierungen, kurzspanend	Aluminium alloys, short chipping	3.2581	G-AISi12	-400	G-IGK-AISi12
	Kupfer-Legierungen, kurzspanend	Copper alloys, short chipping	2.0402	MS58	-500	CuZn40Pb2
S	Titan-Legierungen, mittelfest	Titanium alloys, medium strength	3.7115	TiAl5Sn2,5	-950	TiAl5Sn2-5
			3.7164	TiAl6V4		Ti6AlV4
	Titan-Legierungen, hochfest	Titanium alloys, high strength	3.7174	TiAl6Sn2	900-1400	TiAl6V6Sn2
	Nickelbasis-Legierungen, mittelfest	Nickel based alloys, medium strength	2.4670	NiCr12Al6MoNb	-950	NiCr12Al6MoNb
Nickelbasis-Legierungen, hochwarmfest	Heat resistant nickel based alloys, high strength	2.4668	NiCr19Fe19NbMo	900-1400	Inconel 718 NiCr19Fe19Nb5Mo3	

Die angegebenen Schnittwerte sind Startwerte und müssen auf die vorhandenen Bedingungen abgestimmt werden.
The cutting data indicated are starting values and must be adjusted to the prevailing conditions.

Vorschub-Korrektur-Faktoren f_1 siehe Seite 33
Feed correction factor f_1 see page 33

Kühlung Coolant	Schnitt- geschwindigkeit Cutting speed v_c (m/min)	Fräserdurchmesser Cutting diameter (mm)								
		Vorschub pro Zahn Feed per tooth f_z (mm/z.)								
		4	5	6	8	10	12	14-16	18-20	
	230	0,04	0,06	0,07	0,09	0,11	0,13	0,18	0,22	
	230	0,04	0,06	0,07	0,09	0,11	0,13	0,18	0,22	
	200	0,04	0,05	0,06	0,08	0,10	0,12	0,16	0,20	
	160	0,04	0,05	0,06	0,08	0,10	0,12	0,16	0,20	
	130	0,03	0,04	0,05	0,07	0,09	0,10	0,14	0,17	
	160	0,04	0,05	0,06	0,08	0,10	0,12	0,16	0,20	
	140	0,03	0,04	0,05	0,06	0,08	0,09	0,12	0,15	
	120	0,03	0,04	0,05	0,06	0,08	0,09	0,12	0,15	
	110	0,03	0,04	0,05	0,06	0,08	0,09	0,12	0,15	
	100	0,03	0,04	0,04	0,06	0,07	0,08	0,11	0,14	
	100	0,02	0,03	0,03	0,04	0,05	0,06	0,08	0,10	
	120	0,03	0,03	0,04	0,05	0,07	0,08	0,10	0,13	
	180	0,06	0,07	0,08	0,11	0,14	0,17	0,22	0,28	
	160	0,05	0,06	0,07	0,10	0,12	0,14	0,19	0,24	
	150	0,04	0,06	0,07	0,09	0,11	0,13	0,18	0,22	
	120	0,04	0,06	0,07	0,09	0,11	0,13	0,18	0,22	
	300	0,05	0,06	0,08	0,10	0,13	0,15	0,20	0,25	
	250	0,04	0,05	0,06	0,08	0,10	0,12	0,16	0,20	
	80	0,03	0,03	0,04	0,05	0,07	0,08	0,10	0,13	
	60	0,02	0,03	0,03	0,04	0,05	0,06	0,08	0,10	
	40	0,03	0,03	0,04	0,05	0,07	0,08	0,10	0,13	
	30	0,02	0,03	0,03	0,04	0,05	0,06	0,08	0,10	

 Trockenbearbeitung, Pressluftkühlung ist vorteilhaft
Dry machining, air-blast cooling is advantageous

 Nassbearbeitung, auf ausreichende Emulsionszuführung achten
Wet machining, sufficient emulsion volume required

HPC01 Rougher 35/38 H
High Performance Cutter für gehärtete Stähle ≤ 55 HRC
High Performance Cutter for hard materials ≤ 55 HRC

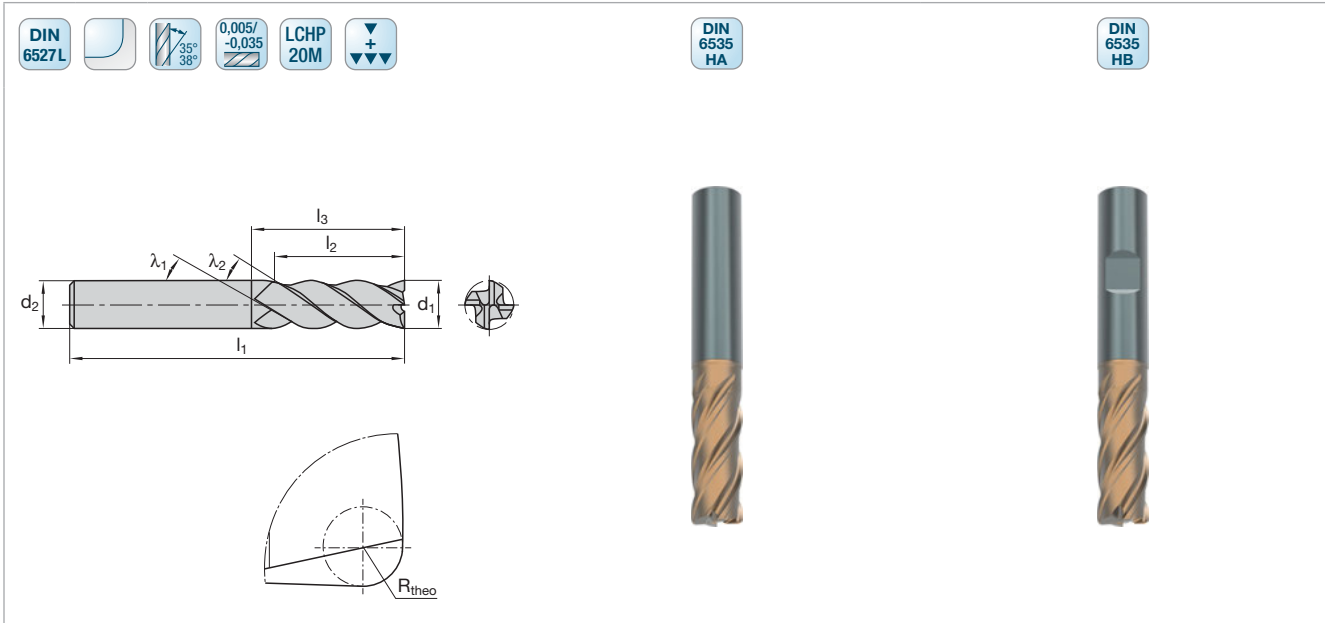

Katalog-Nr. Cat.-No.		HPC01-H-A				HPC01-H-B				
P		■				■				
M		□				□				
K		□				□				
N		□				□				
S		□				□				
H		■				■				
O		□				□				
d ₁	l ₂	l ₁	l ₃	d ₂	R _{theo} (+ 0,1)	z	Ident No.	LMT-Code	Ident No.	LMT-Code
kurz short										
6	7	54	16	6	0,5	4	7429426	EM-HPC01 H6.0x7/16 4R0.5HA	7429435	EM-HPC01 H6.0x7/16 4R0.5HB
8	9	58	20	8	0,5	4	7429427	EM-HPC01 H8.0x9/20 4R0.5HA	7429436	EM-HPC01 H8.0x9/20 4R0.5HB
10	11	66	24	10	0,5	4	7429428	EM-HPC01 H10.0x11/24 4R0.5HA	7429437	EM-HPC01 H10.0x11/24 4R0.5HB
12	12	73	26	12	0,5	4	7429429	EM-HPC01 H12.0x12/26 4R0.5HA	7429438	EM-HPC01 H12.0x12/26 4R0.5HB
12	12	73	26	12	1	4	7429430	EM-HPC01 H12.0x12/26 4R1.0HA	7429439	EM-HPC01 H12.0x12/26 4R1.0HB
16	16	82	32	16	0,5	4	7429431	EM-HPC01 H16.0x16/32 4R0.5HA	7429440	EM-HPC01 H16.0x16/32 4R0.5HB
16	16	82	32	16	1	4	7429432	EM-HPC01 H16.0x16/32 4R1.0HA	7429441	EM-HPC01 H16.0x16/32 4R1.0HB
20	20	92	40	20	0,5	4	7429433	EM-HPC01 H20.0x20/40 4R0.5HA	7429442	EM-HPC01 H20.0x20/40 4R0.5HB
20	20	92	40	20	1	4	7429434	EM-HPC01 H20.0x20/40 4R1.0HA	7429443	EM-HPC01 H20.0x20/40 4R1.0HB
lang long										
6	15	57	21	6	0,5	4	7429444	EM-HPC01 H6.0x15/21 4R0.5HA	7429453	EM-HPC01 H6.0x15/21 4R0.5HB
8	20	63	27	8	0,5	4	7429445	EM-HPC01 H8.0x20/27 4R0.5HA	7429454	EM-HPC01 H8.0x20/27 4R0.5HB
10	25	72	32	10	0,5	4	7429446	EM-HPC01 H10.0x25/32 4R0.5HA	7429455	EM-HPC01 H10.0x25/32 4R0.5HB
12	30	83	38	12	0,5	4	7429447	EM-HPC01 H12.0x30/38 4R0.5HA	7429456	EM-HPC01 H12.0x30/38 4R0.5HB
12	30	83	38	12	1	4	7429448	EM-HPC01 H12.0x30/38 4R1.0HA	7429457	EM-HPC01 H12.0x30/38 4R1.0HB
16	35	92	44	16	0,5	4	7429449	EM-HPC01 H16.0x35/44 4R0.5HA	7429458	EM-HPC01 H16.0x35/44 4R0.5HB
16	35	92	44	16	1	4	7429450	EM-HPC01 H16.0x35/44 4R1.0HA	7429459	EM-HPC01 H16.0x35/44 4R1.0HB
20	44	104	54	20	0,5	4	7429451	EM-HPC01 H20.0x44/54 4R0.5HA	7429460	EM-HPC01 H20.0x44/54 4R0.5HB
20	44	104	54	20	1	4	7429452	EM-HPC01 H20.0x44/54 4R1.0HA	7429461	EM-HPC01 H20.0x44/54 4R1.0HB

Schnittwertempfehlungen ab Seite 38
 Cutting data recommendations starting page 38

■ = Hauptanwendung First choice
 □ = Nebenanwendung Second choice

HPC01 Rougher 35/38 H
Schnittwertempfehlungen
Cutting data recommendations

Werkstoff	Material	Werkstoff-Nr. Material No.	DIN	R _m /UTS (N/mm ²)	DIN	
			Bezeichnung Alt Description Old		Bezeichnung Neu Description New	
P	Nitrier- und Vergütungsstahl	Nitriding steel, heat treated	1.7225	42CrMo4	950–1400	42CrMo4
			1.2344	X40CrMoV5.1	–900	X40CrMoV5-1
			1.4104	X12CrMoS17	500–950	X14CrMoS17
			1.8504	34CrAl6	950–1400	34CrAl6
	Werkzeugstahl	Tool steel	1.2343	X38CrMoV5 1	950–1400	X37CrMoV5-1
			1.6580	30CrNiMo8	950–1400	30CrNiMo8
			1.2379	X155CrVMo12 1	–950	X153CrMoV12-1
			1.2080	X210Cr12	950–1400	X210Cr12
			1.2311	40CrMnMo7	–1100	40CrMnMo7
			1.2312	40CrMnNiMoS8.6	–1150	40CrMnNiMoS8-6
			1.2738	45CrMnNiMo8.6.4	950–1150	45CrMnNiMo8-6-4
			1.2358	60CrMoV18-5	850–1000	60CrMoV18-5
		1.2714	55NiCrMoV7	1100–1350	55NiCrMoV7	
K	Grauguss	Grey cast iron	0.6025	GG25	100–400 (120–260 HB)	EN-GJ1-250
	Legierter Grauguss	Alloyed grey cast iron	0.6678	GGL-NiCr35 2	150–250 (160–230 HB)	EN-GJLA-XNiCr35-2
	Sphäroguss	Nodular cast iron	0.7060 0.7070	GGG60 GGG70L	400–800 (120–310 HB)	EN-GJS-600-3 EN-GJS-700-2U
	Temperguss	Malleable cast iron	0.8155	GTS55	350–700 (150–280 HB)	EN-GJMB-550-4
H	Hartguss	Chilled cast iron		Ni-hard, Ampco	300–600 HB	Ni-hard, Ampco
	Gehärteter Stahl	Hardened steel		Sleipner, Toolox	45–49 HRC	Sleipner, Toolox
				Dievar	50–53 HRC	Dievar
				Vandis, Sverker	54–55 HRC	Vandis, Sverker

Die angegebenen Schnittwerte sind Startwerte und müssen auf die vorhandenen Bedingungen abgestimmt werden.
 The cutting data indicated are starting values and must be adjusted to the prevailing conditions.

Berechnungsformeln und Vorschubkorrekturfaktoren
Calculation formula and feed correction factors

Drehzahl Speed n (min ⁻¹): $n = \frac{v_c \cdot 1000}{\pi \cdot d_1}$	Vorschubkorrektur Feed correction f ₁			
	a _e	a _p	HPC01-H kurz short f ₁	HPC01-H lang long f ₁
Vorschubgeschwindigkeit Feed rate v _f (mm/min): $v_f = f_z \cdot z \cdot n \cdot f_1$	0,1 · d ₁	1 x d ₁	2	1,8
		1,5 x d ₁	–	1,6
	0,25 · d ₁	2 x d ₁	–	1,4
		1 x d ₁	1,9	1,4
		1,5 x d ₁	–	1,2
	0,5 · d ₁	2 x d ₁	–	1
		1 x d ₁	1,4	1
		1,5 x d ₁	–	0,8
	0,75 · d ₁	2 x d ₁	–	0,6
		1 x d ₁	0,9	0,6
	1 · d ₁	1,5 x d ₁	–	0,5
		1 x d ₁	0,5 x d ₁	0,7
		1 x d ₁	0,6	0,5

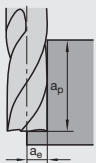
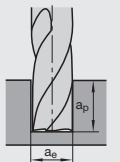
a_e = Schnittbreite Width of cut in mm
 a_p = Schnitttiefe Depth of cut in mm
 d₁ = Durchmesser Cutter diameter in mm
 f₁ = Korrekturfaktor für Correction factor v_f
 f_z = Vorschub pro Zahn Feed per tooth in mm
 n = Drehzahl Speed in min⁻¹
 v_f = Vorschubgeschwindigkeit Feed rate in mm/min
 z = Anzahl der Schneiden No. of teeth

Trockenbearbeitung, auf ausreichende Pressluftzuführung achten. Nutenbearbeitung mit ausreichend Pressluftzufuhr um Spänestau zu vermeiden.
 Dry machining, mind sufficient air-blast cooling. Slot milling, sufficient air-blast cooling avoids chip congestion

	Schnittgeschwindigkeit Cutting speed v_c (m/min)	Fräserdurchmesser Cutting diameter (mm)		
		Vorschub pro Zahn Feed per tooth f_z (mm/z.)		
		Ø 6-8	Ø 10-12	Ø 16-20
	120-140	0,04-0,06	0,06-0,08	0,15-0,18
	120-140	0,04-0,06	0,06-0,08	0,15-0,18
	120-140	0,04-0,06	0,06-0,08	0,15-0,18
	120-140	0,04-0,06	0,06-0,08	0,15-0,18
	100-120	0,03-0,05	0,05-0,08	0,12-0,15
	120-140	0,03-0,05	0,05-0,08	0,12-0,15
	100-120	0,03-0,05	0,05-0,08	0,12-0,15
	100-120	0,03-0,05	0,05-0,08	0,12-0,15
	120-140	0,03-0,05	0,05-0,08	0,12-0,15
	140-160	0,03-0,05	0,05-0,08	0,12-0,15
	120-140	0,03-0,05	0,05-0,08	0,12-0,15
	100-120	0,03-0,05	0,05-0,08	0,12-0,15
	100-120	0,03-0,05	0,05-0,08	0,12-0,15
	180-220	0,09-0,12	0,15-0,18	0,22-0,28
	160-180	0,08-0,11	0,13-0,16	0,20-0,26
	150-180	0,07-0,10	0,12-0,14	0,19-0,24
	120-150	0,07-0,10	0,12-0,14	0,19-0,24
	80-100	0,01-0,02	0,02-0,03	0,04-0,05
	100-120	0,02-0,03	0,04-0,05	0,08-0,10
	80-100	0,01-0,02	0,02-0,03	0,06-0,08
	80	0,01-0,02	0,02-0,03	0,05-0,06

Die AMC-Werkzeuge von LMT Onsrud sind herausragend abgestimmt auf die Bearbeitung von Aluminium Legierungen jeder Art. Mit der Zirkonium-Nitrid-Beschichtung erreichen sie außerordentlich hohe Standzeiten bei gleichbeliebender Oberflächenqualität des Bauteils.

The AMC Tools from LMT Onsrud are perfectly fit to the machining of all kinds of aluminium alloys. With our zirconium nitride coating you will reach outstanding high tool life with equal surface quality of the machined part.

Die Werkzeuge:

- 2-Schneider im Durchmesserbereich 3–20 mm
- 3-Schneider im Durchmesserbereich 3–20 mm unbeschichtet und ZRN beschichtet
- 2-schneidiger Radiuskopierfräser
- 37° Spiralwinkel
- Schneidentoleranz h6
- Schaft nach DIN 6535 HA

The Tools:

- 2-flute cutter diameter range 3–20 mm
- 3-flute cutter diameter range 3–20 mm uncoated and ZRN coated
- 2-flute ball nose end mills
- 37° helix angle
- Cutting edge tolerance h6
- Shank according to DIN 6535 HA

Die Anwendung:

- Hauptanwendung ISO-N
- Zum Schruppen und Schlichten
- Seitliches Fräsen, Vollnuten, Taschenfräsen, Schräg eintauchen, Plungen und Konturenfräsen

The Application:

- First choice ISO-N
- For roughing and finishing
- Side milling, slot milling, pocket milling, plunge milling (inclined and straight) and contour milling

Einsetzbar im Allgemeinen Maschinenbau, der Luft und Raumfahrt und überall dort, wo Aluminium zerspannt wird.

Applicable in the sectors of General machining, Aerospace and everywhere where aluminium has to be machined.

Ihre Vorteile:

- Längere Schneide von 2–3 mm im Vergleich zu Standard Werkzeugen dieser Art mit einer Länge nach DIN 6527 L
- Perfekte Oberflächen und damit weniger Nacharbeit beim Freiformfräsen mit dem Radiuskopierfräser
- Lange Standzeiten und weniger Aufbauscheidenbildung durch die ZRN-Beschichtung
- Genauere Toleranzen durch die Schneidenausführung h6
- Bessere Oberflächengüten am Taschenboden dank modifizierter Schneidenausführung

Your Advantages:

- Longer cutting edge length of 2–3 mm in comparison to standard tools with a length according to DIN 6527 L
- Perfect surfaces and thereby less reworking when milling free-form surfaces with the radius copy-cutter
- Long tool life and less risk of built-up edges through the ZRN coating
- Most exact tolerances through the cutting edge form h6.
- Higher surface quality at the pocket bottom due to latest cutting edge design

AMC Eigenschaften auf einen Blick Features at a glance

ZRN-Beschichtung
gegen Aufbauschneide
ZRN coating against
built-up edges

+ 3 mm mehr Schneidenlänge
+ 3 mm more cutting length

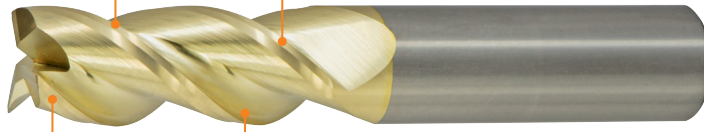

Bestätigte AMC-Geometrie
Proven AMC geometry

Polierte Spankammern für besseren Spänentransport
Polished chip spaces for improved chip removal

Anwendungsbeispiel Application example



Maschinenbau, Freiformfläche
General machining, free-form surface

Werkzeug Tool:
AMC Radiuskopierfräser AMC Radius copy-cutter
EM-AMC01 N20.0x30/53 2BHA
 $d_1 = 20 \text{ mm}$, $z = 2$
unbeschichtet uncoated

Schneidstoff Cutting material:
LWN30W

Werkstoff Material:
AlCuMg2, 3.1355

Schnittwerte Cutting data:
 $v_c = 1195 \text{ m/min}$ $v_f = 6850 \text{ mm/min}$
 $n = 19000 \text{ min}^{-1}$ $a_e = 0,4 \text{ mm}$
 $f_z = 0,18 \text{ mm}$ $a_p = 0,5 \text{ mm}$

Ergebnis Result:
Extrem hochwertige und gute Oberfläche ohne Risse und Schlieren.
Extremely high surface quality without cracks or flow marks.

Katalog-Nr.						AMC01-U-A		AMC01-U-A	
P									
M									
K									
N						■		■	
S									
H									
d ₁	l ₂	l ₁	l ₃	d ₂	z	Ident No.	LMT-Code	Ident No.	LMT-Code
lang long									
3	11	60	-	6	3	2648870	EM-AMC01 N3.0x11 3SHA	2648879	EM-AMC01 N3.0x11 3SHA
4	16	60	-	6	3	2648871	EM-AMC01 N4.0x16 3SHA	2648880	EM-AMC01 N4.0x16 3SHA
5	16	60	-	6	3	2648872	EM-AMC01 N5.0x16 3SHA	2648881	EM-AMC01 N5.0x16 3SHA
6	16	60	-	6	3	2648873	EM-AMC01 N6.0x16 3SHA	2648882	EM-AMC01 N6.0x16 3SHA
8	22	69	-	8	3	2648874	EM-AMC01 N8.0x22 3SHA	2648883	EM-AMC01 N8.0x22 3SHA
10	25	75	31	10	3	2648875	EM-AMC01 N10.0x25/31 3SHA	2648884	EM-AMC01 N10.0x25/31 3SHA
12	30	87	37	12	3	2648876	EM-AMC01 N12.0x30/37 3SHA	2648885	EM-AMC01 N12.0x30/37 3SHA
16	35	100	43	16	3	2648877	EM-AMC01 N16.0x35/43 3SHA	2648886	EM-AMC01 N16.0x35/43 3SHA
20	42	115	53	20	3	2648878	EM-AMC01 N20.0x42/53 3SHA	2648887	EM-AMC01 N20.0x42/53 3SHA

Schnittwertempfehlungen ab Seite 46
Cutting data recommendations starting page 46

■ = Hauptanwendung First choice
□ = Nebenanwendung Second choice

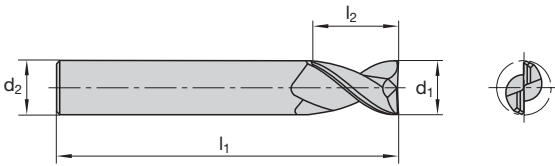

Katalog-Nr. Cat.-No.					AMC01-N-A		
P							
M							
K							
N					■		
S							
H							
d ₁	l ₂	l ₁	d ₂	z	Ident No.	LMT-Code	
lang long							
3	11	60	6	2	2648861	EM-AMC01 N3.0x11 2SHA	
4	16	60	6	2	2648862	EM-AMC01 N4.0x16 2SHA	
5	16	60	6	2	2648863	EM-AMC01 N5.0x16 2SHA	
6	16	60	6	2	2648864	EM-AMC01 N6.0x16 2SHA	
8	22	69	8	2	2648865	EM-AMC01 N8.0x22 2SHA	
10	25	75	10	2	2648866	EM-AMC01 N10.0x25 2SHA	
12	30	87	12	2	2648867	EM-AMC01 N12.0x30 2SHA	
16	32	100	16	2	2648868	EM-AMC01 N16.0x35 2SHA	
20	42	115	20	2	2648869	EM-AMC01 N20.0x42 2SHA	

Schnittwertempfehlungen ab Seite 46
Cutting data recommendations starting page 46

■ = Hauptanwendung First choice
□ = Nebenanwendung Second choice

AMC01 Ball-Nose-Finisher 37 N
Radiuskopierfräser
Ball nose end mills

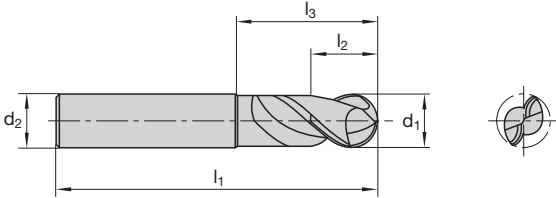

Katalog-Nr. Cat.-No.						AMC01-N-A		
P								
M								
K								
N							■	
S								
H								
d ₁	l ₂	l ₁	l ₃	d ₂	z	Ident No.	LMT-Code	
						lang long		
3	6	60	15	6	2	2648894	EM-AMC01 N3.0x6/15 2BHA	
4	6	60	16	6	2	2648895	EM-AMC01 N4.0x6/16 2BHA	
5	8	60	18	6	2	2648896	EM-AMC01 N5.0x8/18 2BHA	
6	10	60	20	6	2	2648897	EM-AMC01 N6.0x10/20 2BHA	
8	12	75	26	8	2	2648898	EM-AMC01 N8.0x12/26 2BHA	
10	15	75	31	10	2	2648899	EM-AMC01 N10.0x15/31 2BHA	
12	18	75	37	12	2	2648900	EM-AMC01 N12.0x18/37 2BHA	
16	24	100	43	16	2	2648901	EM-AMC01 N16.0x24/43 2BHA	
20	30	100	53	20	2	2648902	EM-AMC01 N20.0x30/53 2BHA	

Schnittwertempfehlungen ab Seite 46
 Cutting data recommendations starting page 46

■ = Hauptanwendung First choice
 □ = Nebenanwendung Second choice



Schnittwertempfehlungen für Aluminium Schafffräser
 Cutting data recommendations for aluminium end mills

Werkstoff	Material	Werkstoff-Nr. Material No.	DIN Bezeichnung Alt DIN Description Old	R_m/UTS (N/mm²)	DIN Bezeichnung Neu DIN Description New
N	Aluminium-Legierungen, kurzspanend	Aluminium alloys, short chipping	3.2581 G-AlSi12	-400	G-IGK-AlSi12
	Aluminium-Legierungen, langspanend	Aluminium alloys, long chipping	3.3535 3.4365 AlMg3 AlZnMgCu1,5	100-400	AlMg3 AlZnMgCu1,5
	Kupfer-Legierungen, kurzspanend	Copper alloys, short chipping	2.0402 MS58	-500	CuZn40Pb2
	Kupfer-Legierungen, langspanend	Copper alloys, long chipping	2.0320 2.0975 MS63 CuAl10Ni	150-250	CuZn37 CuAl10Fe5Ni5-C
	Magnesium-Legierungen	Magnesium alloys	3.5912 G-MgAl9Zn1	200-300	G-MgAl9Zn1

	Schnitt- geschwindigkeit Cutting speed v_c (m/min)	Eingriffs- breite Cutting width a_e (mm)	Fräserdurchmesser Cutting diameter (mm)								
			Vorschub pro Zahn Feed per tooth f_z (mm/z.)								
			3	4	5	6	8	10	12	16	20
	220	1 x d_1	0,025–0,04	0,025–0,05	0,03–0,06	0,04–0,09	0,05–0,12	0,06–0,14	0,08–0,18	0,1–0,25	0,13–0,29
	300	0,33 x d_1									
	430	0,1 x d_1									
	250	0,05 x d_1									
	250	1 x d_1	0,03–0,05	0,03–0,06	0,035–0,08	0,05–0,1	0,06–0,13	0,07–0,15	0,09–0,21	0,12–0,27	0,14–0,3
	360	0,33 x d_1									
	610	0,1 x d_1									
	300	0,05 x d_1									
	150	1 x d_1	0,03–0,06	0,03–0,08	0,04–0,09	0,01–0,011	0,06–0,13	0,08–0,18	0,1–0,23	0,13–0,29	0,15–0,33
	200	0,33 x d_1									
	280	0,1 x d_1									
	200	0,05 x d_1									
	150	1 x d_1	0,02–0,04	0,025–0,05	0,03–0,06	0,04–0,09	0,05–0,11	0,06–0,14	0,08–0,18	0,11–0,25	0,13–0,29
	200	0,33 x d_1									
	280	0,1 x d_1									
	200	0,05 x d_1									
	150	1 x d_1	0,03–0,06	0,03–0,08	0,04–0,09	0,05–0,11	0,05–0,13	0,08–0,18	0,1–0,23	0,13–0,29	0,15–0,34
	180	0,33 x d_1									
	250	0,1 x d_1									
	180	0,05 x d_1									

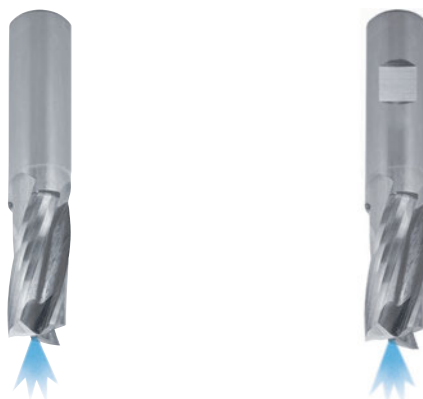
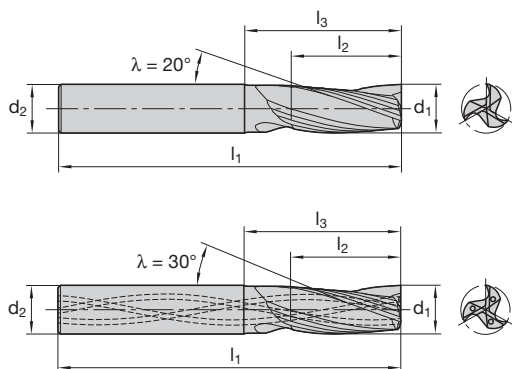

Katalog-Nr. Cat.-No.						1571		1572	
P									
M									
K									
N						■		■	
S									
H									
d ₁	l ₂	l ₁	l ₃	d ₂	z	Ident No.	LMT-Code	Ident No.	LMT-Code
lang long									
ohne zentrale Innenkühlung without internal coolant λ = 20°									
4	11	57	21	6	2	1121971	EM-ASH 4x11/21 2SA	1121975	EM-ASH 4x11/21 2SB
5	13	57	21	6	2	1121972	EM-ASH 5x13/21 2SA	1121976	EM-ASH 5x13/21 2SB
6	13	57	21	6	2	1121973	EM-ASH 6x13/21 2SA	1121977	EM-ASH 6x13/21 2SB
8	19	63	27	8	2	1121909	EM-ASH 8x19/27 2SA	1121918	EM-ASH 8x19/27 2SB
10	22	72	32	10	2	1121910	EM-ASH 10x22/32 2SA	1121919	EM-ASH 10x22/32 2SB
12	26	83	38	12	3	1121911	EM-ASH 12x26/38 3SA	1121920	EM-ASH 12x26/38 3SB
14	26	83	38	14	3	1121912	EM-ASH 14x26/38 3SA	1121921	EM-ASH 14x26/38 3SB
16	32	92	44	16	3	1121913	EM-ASH 16x32/44 3SA	1121922	EM-ASH 16x32/44 3SB
18	32	92	44	18	3	1121916	EM-ASH 18x32/44 3SA	1121924	EM-ASH 18x32/44 3SB
20	38	104	54	20	3	1121917	EM-ASH 20x38/54 3SA	1121925	EM-ASH 20x38/54 3SB
25	45	121	65	25	3	1121974	EM-ASH 25x45/65 3SA	1121979	EM-ASH 25x45/65 3SB
mit zentraler Innenkühlung with internal coolant λ = 30°									
12	26	83	38	12	3	1110002	EM-ASH 12x26/38 3SA-I	1110008	EM-ASH 12x26/38 3SB-I
16	32	92	44	16	3	1110003	EM-ASH 16x32/44 3SA-I	1110009	EM-ASH 16x32/44 3SB-I
20	38	104	54	20	3	1110004	EM-ASH 20x38/54 3SA-I	1110010	EM-ASH 20x38/54 3SB-I

Schnittwertempfehlungen ab Seite 50
Cutting data recommendations starting page 50

■ = Hauptanwendung First choice
□ = Nebenanwendung Second choice

AIRline
Schnittwertempfehlungen und Vorschübe für Schafffräser
Cutting data recommendations and feeds for end mills

Werkstoff	Material	Werkstoff-Nr. Material No.	DIN Bezeichnung Alt DIN Description Old	R _m /UTS (N/mm ²)	DIN Bezeichnung Neu DIN Description New
N	Rein-Metalle, weich	Pure metals, soft	1.1003 Reineisen, Blei Pure iron, lead	400–800	Reineisen, Blei Pure iron, lead
	Aluminium-Legierungen, kurzspanend	Aluminium alloys, short chipping	3.2581 G-AlSi12	–400	G-IGK-AlSi12
	Aluminium-Legierungen, langspanend	Aluminium alloys, long chipping	3.3535 3.4365 AlMg3 AlZnMgCu1,5	100–400	AlMg3 AlZnMgCu1,5
	Kupfer-Legierungen, kurzspanend	Copper alloys, short chipping	2.0402 MS58	–500	CuZn40Pb2
	Kupfer-Legierungen, langspanend	Copper alloys, long chipping	2.0320 2.0975 MS63 CuAl10Ni	150–250	CuZn37 CuAl10Fe5Ni5-C
	Magnesium-Legierungen	Magnesium alloys	3.5912 G-MgAl9Zn1	200–300	G-MgAl9Zn1
	Thermoplaste	Thermoplastics		400–700	PVC, Acrylglas PVC, acrylic glass
	Duroplaste	Duroplastics		20–40	Bakelit, Melamin

Die angegebenen Schnittwerte sind Startwerte und müssen auf die vorhandenen Bedingungen abgestimmt werden.
 The cutting data indicated are starting values and must be adjusted to the prevailing conditions.

AIRline
Berechnungsformeln und Vorschubkorrekturfaktoren für Schafffräser
Calculating formulas and cutting speed correction factor end mills

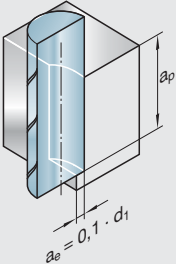
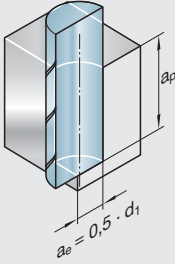
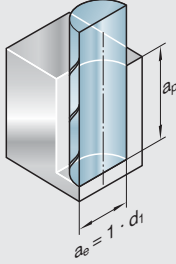
Drehzahl Speed n (min⁻¹): $n = \frac{v_c \cdot 1000}{\pi \cdot d_1}$	Vorschubgeschwindigkeit Feed rate v_f (mm/min): $v_f = f_z \cdot z \cdot n \cdot f_2$	a _e = Schnittbreite Width of cut (mm) a _p = Schnitttiefe Depth of cut (mm) d ₁ = Durchmesser Diameter (mm) f ₂ = Korrekturfaktor für v _f Correction factor v _f f _z = Vorschub pro Zahn Feed per tooth (mm) n = Drehzahl Speed (min ⁻¹) v _c = Schnittgeschwindigkeit Cutting speed (m/min) v _f = Vorschubgeschwindigkeit Feed rate (mm/min) z = Anzahl der Schneiden Number of teeth	
Vorschubkorrektur f₂ Cutting speed correction factor f₂ Fräser mit Schrupp-Profil Milling cutters with roughing-profile			
f ₂ =	1,0	0,8	0,6

HM-Sorte Carbide grade	Schnitt- geschwindigkeit Cutting speed v_c (m/min)	Kühlung Coolant	Fräserdurchmesser Cutting diameter (mm)					
			Vorschub pro Zahn f_z bei Fräser-Ø Feed per tooth f_z for cutter diameter d_1 (mm)					
			Schruppen Roughing			Schlichten Finishing		
			8	12	16	8	12	16
LWN30M	400		0,10	0,20	0,30	0,02	0,07	0,10
	280		0,10	0,20	0,30	0,06	0,08	0,12
	900		0,10	0,20	0,30	0,06	0,08	0,12
	280		0,10	0,20	0,30	0,05	0,07	0,10
	280		0,10	0,20	0,30	0,05	0,07	0,10
	500		0,10	0,20	0,30	0,06	0,08	0,12
	300		0,10	0,20	0,03	0,05	0,10	0,14
	300		0,10	0,20	0,30	0,05	0,10	0,14

Nassbearbeitung, auf ausreichende Emulsionszuführung achten
Wet machining, sufficient emulsion volume required

Fräser mit Schlicht-Profil Milling cutters with finishing-profile			
$f_2 =$	1,0	0,6	0,5
Bohren auf volle Tiefe und anschließendes Längsfräsen Plunging to full depth and slot milling		I. Bohren	II. Fräsen
$f_2 =$	0,3	0,5	

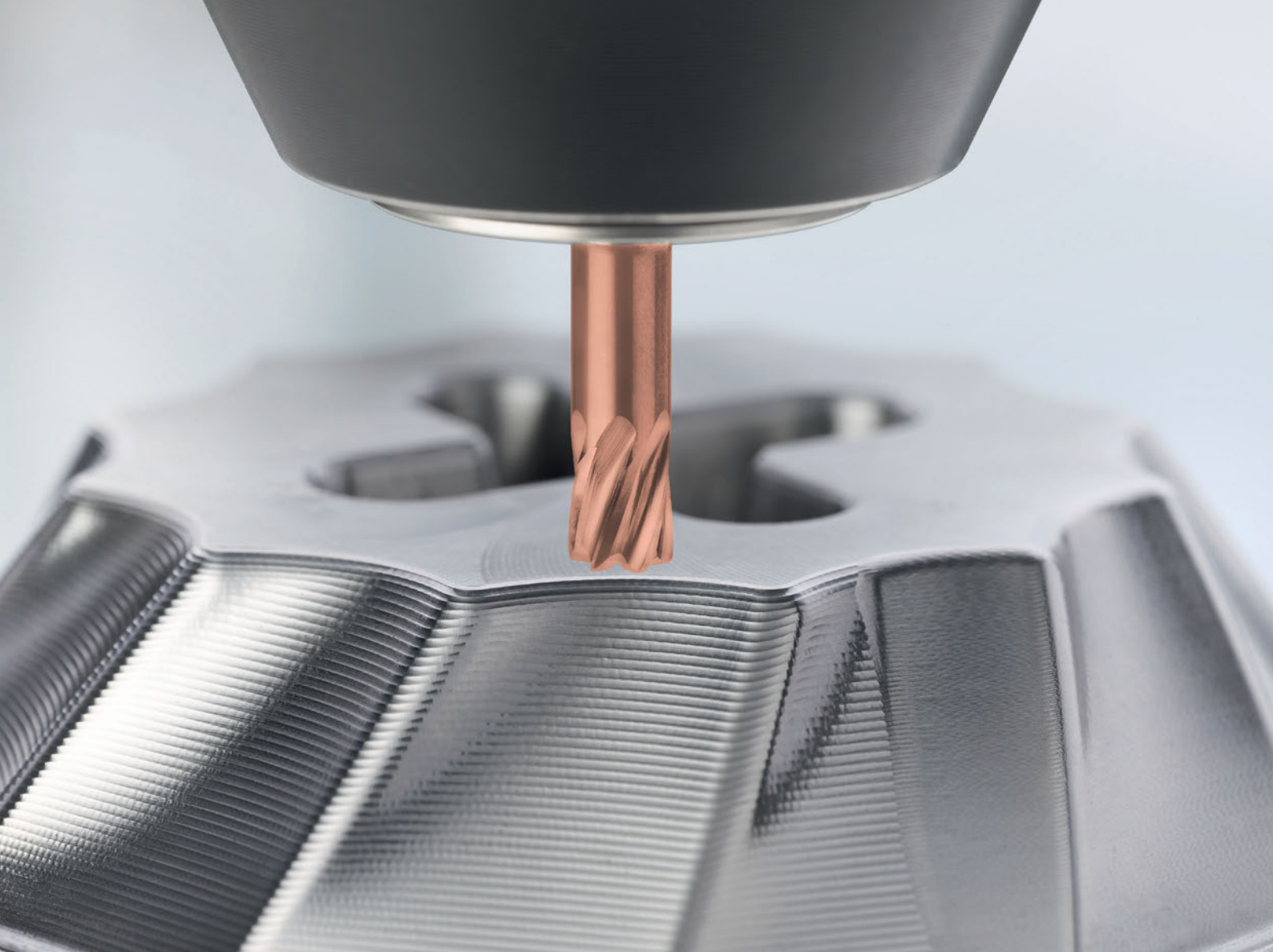

HFC – High Feed Cutter

Die neue Generation der
Hochvorschubfräser-Serie
The New Generation of the
High Feed Milling Cutter Series

Ob Sie im Gesenk- und Formenbau, im allgemeinen Maschinenbau, in der Luft- und Raumfahrt oder in anderen Branchen tätig sind – Überall, wo das Hochvorschubfräsen zur Anwendung kommt, sind unsere HFC Werkzeuge die beste Wahl für Sie. Erleben Sie jetzt die Zukunft des Hochvorschubfräsens mit unserer neuen HFC-Familie und steigern Sie Ihre Effizienz sowie Produktivität auf ein neues Level!

Whether you are in die and mold making, general machining, aerospace or other industries – wherever high feed milling is used, our HFC tools are the best choice for you. Experience the future of high feed milling with our new HFC family and increase your efficiency and productivity to a new level!

Ihre Vorteile:

- Hohe Schneidenzahl ermöglicht hohe Bahnvorschübe für eine hohe Produktivität
- Längere Standzeiten dank neuester Substrate und Beschichtungen
- Große Auswahl an verschiedenen Geometrien und Längen für unterschiedlichste Anwendungen
- Erhöhte Lebensdauer bei der Bearbeitung von rostfreien Stählen bei der Verwendung von Werkzeugen mit Innenkühlung

Your advantages:

- Longer tool life thanks to the latest substrates and coatings
- Increased tool life when machining stainless steels when using tools with internal cooling
- Extensive range of different lengths for use in a wide variety of applications
- High number of cutting edges enables high feed rates for high productivity

Merkmale:

Features:

Glatter Zylinderschaft
Cylindrical shank

Halsfreischliff
Neck relief

Modernste Beschichtung
Latest generation coating

Verlängerte Mantelschneide, nachschleifbar
Extended sheath cutting edge, regrindable







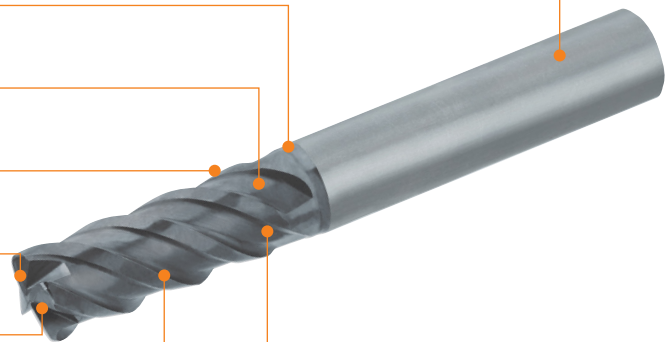

Mikroschneidkantenpräparation
Micro cutting-edge preparation

S-Schliff ähnliche Ausführung der Schneidkante
S-shape design

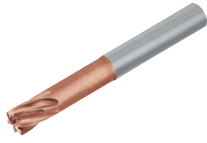
Schneidstoff an die jeweilige Anwendung angepasst
Grade trimmed to respective focus applications

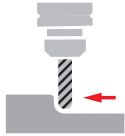
Speziell auf die Anwendung abgestimmte Geometrie
Geometry specially adapted to the application



HFC P	HFC M	HFC H	HFC U	
				
Für Stahl und Guss For steel and cast iron	Für austenitische Stähle und Superlegierungen For austenitic steels and superalloys	Für gehärtete Stähle bis zu 65 HRC For hardened steels up to 65 HRC	Universallösung für ISO-Gruppen P, M und K Universal solution for ISO groups P, M and K	
P Nebenanwendung: Second choice: K	M Nebenanwendung: Second choice: S	H Nebenanwendung: Second choice: P K	P M K Nebenanwend.: Second choice: H	
 Hochvorschubfräsen High feed milling	 Kopierfräsen Copy milling	 Nutenfräsen Groove milling	 Taschenfräsen Pocket milling	 Zirkularfräsen Circular milling

HFC01 Rougher P
Hochvorschubfräser für hochlegierte Stähle
High feed end mills for high alloy steels

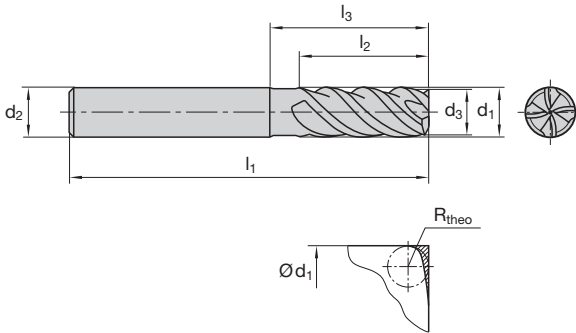

Katalog-Nr. Cat.-No.		HFC01-P-A									
P		■									
M											
K		□									
N											
S											
H											
d ₁	d ₃	l ₂	l ₁	l ₃	d ₂	z	R _{theo}	a _{p max}	Ident No.	LMT-Code	
extra kurz extra short											
2	1,85	3	40	5	4	2	0,2	0,1	7430016	EM-HFC01 P2.0x3/5 2R0.2HA	
3	2,85	4	50	7	6	2	0,3	0,15	7430017	EM-HFC01 P3.0x4/7 2R0.3HA	
4	3,8	5	54	9	6	4	0,4	0,2	7430018	EM-HFC01 P4.0x5/9 4R0.4HA	
5	4,8	6	54	11	6	4	0,5	0,25	7430019	EM-HFC01 P5.0x6/11 4R0.5HA	
6	5,7	7	54	13	6	4	0,6	0,3	7430020	EM-HFC01 P6.0x7/13 4R0.6HA	
8	7,7	9	58	17	8	4	0,8	0,4	7430021	EM-HFC01 P8.0x9/17 4R0.8HA	
10	9,7	11	66	22	10	4	1	0,5	7430022	EM-HFC01 P10.0x11/22 4R1.0HA	
12	11,7	13	73	26	12	4	1,2	0,6	7430023	EM-HFC01 P12.0x13/26 4R1.2HA	
kurz short											
1	0,95	3	38	6	3	2	0,1	0,05	7430024	EM-HFC01 P1.0x3/6 2R0.1HA	
2	1,85	6	40	9	4	2	0,2	0,1	7430025	EM-HFC01 P2.0x6/9 2R0.2HA	
3	2,85	8	54	12	6	2	0,3	0,15	7430026	EM-HFC01 P3.0x8/12 2R0.3HA	
4	3,8	11	57	21	6	4	0,4	0,2	7430027	EM-HFC01 P4.0x11/21 4R0.4HA	
5	4,8	14	57	21	6	4	0,5	0,25	7430028	EM-HFC01 P5.0x14/21 4R0.5HA	
6	5,7	16	57	21	6	4	0,6	0,3	7430029	EM-HFC01 P6.0x16/21 4R0.6HA	
8	7,7	21	63	27	8	4	0,8	0,4	7430030	EM-HFC01 P8.0x21/27 4R0.8HA	
10	9,7	26	72	32	10	4	1	0,5	7430031	EM-HFC01 P10.0x26/32 4R1.0HA	
12	11,7	31	83	38	12	4	1,2	0,6	7430032	EM-HFC01 P12.0x31/38 4R1.2HA	
16	15,7	40	92	44	16	4	1,6	0,8	7430033	EM-HFC01 P16.0x40/44 4R1.6HA	
lang long											
4	3,8	11	70	24	6	4	0,4	0,2	7430034	EM-HFC01 P4.0x11/24 4R0.4HA	
5	4,8	14	70	30	6	4	0,5	0,25	7430035	EM-HFC01 P5.0x14/30 4R0.5HA	
6	5,7	16	80	35	6	4	0,6	0,3	7430036	EM-HFC01 P6.0x16/35 4R0.6HA	
8	7,7	21	80	40	8	4	0,8	0,4	7430037	EM-HFC01 P8.0x21/40 4R0.8HA	
10	9,7	26	90	45	10	4	1	0,5	7430038	EM-HFC01 P10.0x26/45 4R1.0HA	
12	11,7	31	100	50	12	4	1,2	0,6	7430039	EM-HFC01 P12.0x31/50 4R1.2HA	
extra lang extra long											
4	3,8	11	80	40	6	4	0,4	0,2	7430040	EM-HFC01 P4.0x11/40 4R0.4HA	
5	4,8	14	80	42	6	4	0,5	0,25	7430041	EM-HFC01 P5.0x14/42 4R0.5HA	
6	5,7	16	100	64	6	4	0,6	0,3	7430042	EM-HFC01 P6.0x16/64 4R0.6HA	
8	7,7	21	120	84	8	4	0,8	0,4	7430043	EM-HFC01 P8.0x21/84 4R0.8HA	
10	9,7	26	150	110	10	4	1	0,5	7430044	EM-HFC01 P10.0x26/110 4R1.0HA	
12	11,7	31	160	110	12	4	1,2	0,6	7430045	EM-HFC01 P12.0x31/110 4R1.2HA	
16	15,7	40	160	110	16	4	1,6	0,8	7430046	EM-HFC01 P16.0x40/110 4R1.6HA	

Schnittwertempfehlungen ab Seite 56
 Cutting data recommendations starting page 56

■ = Hauptanwendung First choice
 □ = Nebenanwendung Second choice

HFC01 Rougher P
Schnittwertempfehlungen
Cutting data recommendations

Werkstoff	Material	Werkstoff-Nr. Material No.	DIN Bezeichnung Alt DIN Description Old	R_m/UTS (N/mm²)	DIN Bezeichnung Neu DIN Description New	
P	Unlegierter Baustahl + Automatenstahl	1.0570	St52-3	-700	S355J2G3	
		1.1730	C45	-800	C45U	
		1.0715	9SMn28	-700	11SMn30	
		1.1191	Ck45	500-950	C45E	
	Vergütungsstahl, mittelfest	Heat-treatment steel, medium strength	1.7219	26CrMo4		26CrMo4-2
			1.7225	42CrMo4	500-950	42CrMo4
	Stahlguss	Cast steel	1.8159	51CrV4		51CrV4
			1.0416	GS40	-950	GS40
	Einsatzstahl	Case hardening steel	1.7131	16MnCr5	-950	16MnCr5
	Rost- und säurebeständiger Stahl, ferritisch, martensitisch	Stainless steel, ferritic, martensitic	1.4006	X10Cr13	500-950	X12Cr13
			1.4104	X12CrMoS17		X14CrMoS17
			1.4122	X35CrMo17		X39CrMo17-1
	Vergütungsstahl, hochfest	Heat-treatment steel, high strength	1.7225	42CrMo4	950-1400	42CrMo4
			1.6580	30CrNiMo8		30CrNiMo8
	Nitrierstahl, vergütet	Nitriding steel, heat treated	1.8504	34CrAl6	950-1400	34CrAl6
			1.2344	X40CrMoV5.1	-900	X40CrMoV5-1
	Werkzeugstahl	Tool steel	1.2343	X38CrMoV5 1	950-1400	X37CrMoV5-1
			1.2316	X38CrMo16	-1100	X38CrMo16
1.2379			X155CrVMo12 1	-950	X153CrMoV12-1	
1.2080			X210Cr12	950-1400	X210Cr12	
1.2358			60CrMoV18-5	850-1000	60CrMoV18-5	
1.2714			55NiCrMoV7	1100-1350	55NiCrMoV7	
1.2311			40CrMnMo7	-1100	40CrMnMo7	
		1.2312	40CrMnNiMoS8.6	-1150	40CrMnNiMoS8-6	
		1.2738	45CrMnNiMo8.6.4	950-1150	45CrMnNiMo8-6-4	
K	Grauguss	0.6025	GG25	100-400 (120-260 HB)	EN-GJI-250	
	Legierter Grauguss	0.6678	GGL-NiCr35 2	150-250 (160-230 HB)	EN-GJLA-XNiCr35-2	
	Sphäroguss	Nodular cast iron	0.7070	GGG70L	400-800 (120-310 HB)	EN-GJS-700-2U
			0.7060	GGG60		EN-GJS-600-3
	Temperguss	Malleable cast iron	0.8155	GTS55	350-700 (150-280 HB)	EN-GJMB-550-4

Die angegebenen Schnittwerte sind Startwerte und müssen auf die vorhandenen Bedingungen abgestimmt werden.
The cutting data indicated are starting values and must be adjusted to the prevailing conditions.

Bei der langen Ausführung empfehlen wir die f_z-Werte um 30 % zu reduzieren.
We recommended to reduce the f_z-value with the long version by 30 %.

Schnittgeschwindigkeit Cutting speed v_c (m/min)	Fräserdurchmesser Cutting diameter (mm)				Schnitttiefe Cutting depth a_p (mm)
	Vorschub pro Zahn Feed per tooth f_z (mm/z.)				
	Ø 1-3	Ø 4-6	Ø 8-10	Ø 12-16	
300	0,30	0,50	0,70	1,00	0,05 x d_1
300	0,30	0,50	0,70	1,00	
300	0,30	0,50	0,70	1,00	
240	0,25	0,40	0,60	0,80	
200	0,25	0,40	0,60	0,80	
240	0,25	0,40	0,60	0,80	0,045 x d_1
200	0,25	0,40	0,60	0,80	
200	0,25	0,40	0,60	0,80	
200	0,25	0,40	0,60	0,80	0,04 x d_1
180	0,25	0,40	0,60	0,80	
220	0,25	0,40	0,60	0,80	
200	0,20	0,40	0,50	0,70	0,04 x d_1
200	0,25	0,40	0,60	0,80	
200	0,25	0,40	0,60	0,80	
250	0,50	0,70	0,90	1,30	0,04 x d_1
250	0,45	0,60	0,80	1,20	
180	0,20	0,30	0,50	0,70	
180	0,30	0,50	0,70	1,00	
150	0,30	0,50	0,70	1,00	

Anwendungsbeispiel Application example

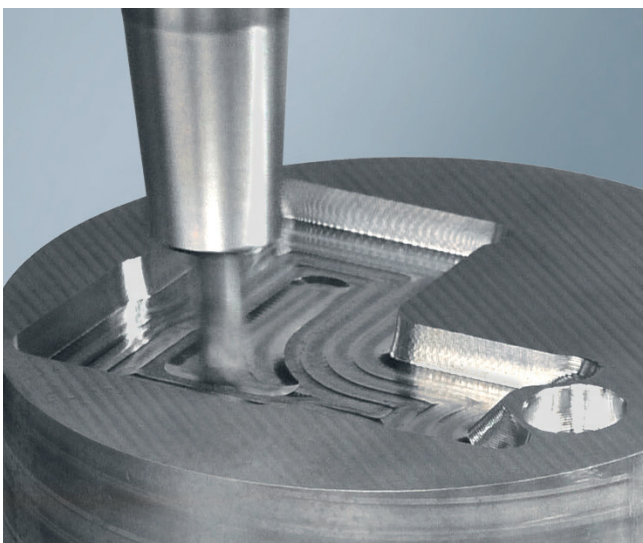

Kopierfräsen, Z-konstant Copying, Z constant

Werkzeug Tool:

HFC P
 $d_1 = 8 \text{ mm}$, $z = 4$

Werkstoff Material:

Werkzeugstahl 1.2312/40CrMnMoS 8-6, P20+S,
 $R_m = 1000 \text{ N/mm}^2$, 30 HRC
Tool steel 1.2312/40CrMnMoS 8-6, P20+S,
 $R_m = 1000 \text{ N/mm}^2$, 30 HRC

Schnittwerte Cutting data:

$v_c = 240 \text{ m/min}$ $v_f = 25000 \text{ mm/min}$
 $n = 9550 \text{ min}^{-1}$ $a_e = 5 \text{ mm}$
 $f_z = 0,65 \text{ mm}$ $a_p = 0,35 \text{ mm}$

Der Hochvorschubfräser für austenitische Stähle High Feed End Mills for Austenitic Steel

Der neue HFC01 Rougher M wurde speziell für die Bearbeitung von ISO-M-Materialien entwickelt. Der Vierschneider deckt mit seinen Längenausführungen extra kurz, kurz, lang und extra lang sowie dem Durchmesserbereich von 4–16 mm bereits ein breites Anwendungsfeld bei rostfreien Stählen, Superlegierungen und Titanbearbeitungen ab. Alle Werkzeuge sind mit innerer Kühlmittelzufuhr ausgelegt.

The new HFC01 Rougher M was especially developed for the machining of ISO-M materials. The 4-flute end mill already covers a broad range of applications in non-ferrous materials, super alloys and titanium with its standard lengths extra short, short, long and extra long and the diameter range of 4–16 mm. All tools are with internal cooling system.

Merkmale:

Features:

Verlängerte Mantelschneide, nachschleifbar
Extended lateral cutting edge, regrindable

45°-Spiralwinkel
45° helix angle

Zentrale
Innenkühlung
Central cooling



„S-Schliff“-ähnliche Schneidkante
Similarity to “S-cutting edge”

Schneidstoff LCMS30M
Cutting grade LCMS30M

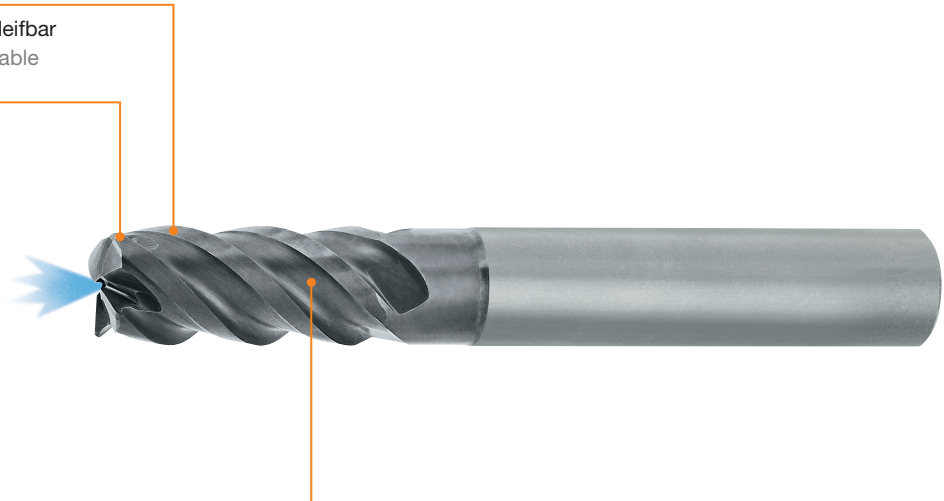

HFC01 Rougher M
Hochvorschubfräser für austenitische Stähle
High feed end mills for austenitic steels



DIN
6535
HA

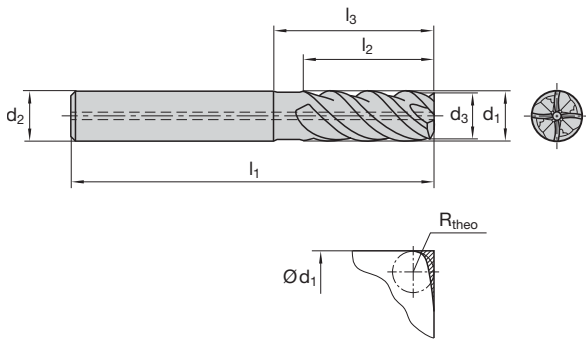

Katalog-Nr. Cat.-No.		HFC01-M-A									
P											
M		■									
K											
N											
S		□									
H											
d ₁	d ₃	l ₂	l ₁	l ₃	d ₂	z	R _{theo}	a _{p max}	Ident No.		LMT-Code
extra kurz extra short											
4	3,8	5	54	9	6	4	0,4	0,2	7430084	EM-HFC01 M4.0x5/9 4R0.4HA-I	
5	4,8	6	54	11	6	4	0,5	0,25	7430085	EM-HFC01 M5.0x6/11 4R0.5HA-I	
6	5,7	7	54	13	6	4	0,6	0,3	7430086	EM-HFC01 M6.0x7/13 4R0.6HA-I	
8	7,7	9	58	17	8	4	0,8	0,4	7430087	EM-HFC01 M8.0x9/17 4R0.8HA-I	
10	9,7	11	66	22	10	4	1	0,5	7430088	EM-HFC01 M10.0x11/22 4R1.0HA-I	
12	11,7	13	73	26	12	4	1,2	0,6	7430089	EM-HFC01 M12.0x13/26 4R1.2HA-I	
16	15,7	17	82	34	16	4	1,6	0,8	7430090	EM-HFC01 M16.0x17/34 4R1.6HA-I	
kurz short											
4	3,8	11	57	16	6	4	0,4	0,2	7430091	EM-HFC01 M4.0x11/16 4R0.4HA-I	
5	4,8	14	57	18	6	4	0,5	0,25	7430092	EM-HFC01 M5.0x14/18 4R0.5HA-I	
6	5,7	16	57	21	6	4	0,6	0,3	7430093	EM-HFC01 M6.0x16/21 4R0.6HA-I	
8	7,7	21	63	27	8	4	0,8	0,4	7430094	EM-HFC01 M8.0x21/27 4R0.8HA-I	
10	9,7	26	72	32	10	4	1	0,5	7430095	EM-HFC01 M10.0x26/32 4R1.0HA-I	
12	11,7	31	83	38	12	4	1,2	0,6	7430096	EM-HFC01 M12.0x31/38 4R1.2HA-I	
16	15,7	40	92	44	16	4	1,6	0,8	7430097	EM-HFC01 M16.0x40/44 4R1.6HA-I	
lang long											
4	3,8	11	69	24	6	4	0,4	0,2	7430098	EM-HFC01 M4.0x11/24 4R0.4HA-I	
5	4,8	14	69	26	6	4	0,5	0,25	7430099	EM-HFC01 M5.0x14/26 4R0.5HA-I	
6	5,7	16	69	33	6	4	0,6	0,3	7430100	EM-HFC01 M6.0x16/33 4R0.6HA-I	
8	7,7	21	75	39	8	4	0,8	0,4	7430101	EM-HFC01 M8.0x21/39 4R0.8HA-I	
10	9,7	26	80	40	10	4	1	0,5	7430102	EM-HFC01 M10.0x26/40 4R1.0HA-I	
12	11,7	31	93	48	12	4	1,2	0,6	7430103	EM-HFC01 M12.0x31/48 4R1.2HA-I	
16	15,7	40	108	60	16	4	1,6	0,8	7430104	EM-HFC01 M16.0x40/60 4R1.6HA-I	
extra lang extra long											
4	3,8	11	69	29	6	4	0,4	0,2	7430105	EM-HFC01 M4.0x11/29 4R0.4HA-I	
5	4,8	14	69	30	6	4	0,5	0,25	7430106	EM-HFC01 M5.0x14/30 4R0.5HA-I	
6	5,7	16	75	39	6	4	0,6	0,3	7430107	EM-HFC01 M6.0x16/39 4R0.6HA-I	
8	7,7	21	83	47	8	4	0,8	0,4	7430108	EM-HFC01 M8.0x21/47 4R0.8HA-I	
10	9,7	26	95	55	10	4	1	0,5	7430109	EM-HFC01 M10.0x26/55 4R1.0HA-I	
12	11,7	31	110	65	12	4	1,2	0,6	7430110	EM-HFC01 M12.0x31/65 4R1.2HA-I	
16	15,7	40	125	77	16	4	1,6	0,8	7430111	EM-HFC01 M16.0x40/77 4R1.6HA-I	



Schnittwertempfehlungen ab Seite 60
 Cutting data recommendations starting page 60

■ = Hauptanwendung First choice
 □ = Nebenanwendung Second choice

HFC01 Rougher M
Schnittwertempfehlungen
Cutting data recommendations

Werkstoff	Material	Werkstoff-Nr. Material No.	DIN Bezeichnung Alt DIN Description Old	R_m/UTS (N/mm²)	DIN Bezeichnung Neu DIN Description New	
M	Rost- und säurebeständiger Stahl, austenitisch	1.4301	X2CrNiMo17-12-2	500-950	X5CrNiMo18-10	
		1.4404	X6CrNiMoTi17-12-2		X2CrNiMo17-12-2	
		1.4571	X10CrNiMoTi18		X10CrNiMoTi18	
	Rost- und säurebeständiger Stahl, ferritisch, martensitisch	Stainless steel, ferritic, martensitic	1.2709	X3NiCoMoTi18-9-5	800-1000	X3NiCoMoTi18-9-5
			1.4542	X5CrNiCuNb16-4		X5CrNiCuNb16-4
	1.4568	X7CrNiAl17-7	X7CrNiAl17-7			
Rost- und säurebeständiger Stahl, martensitisch aushärtbar	Stainless steel, martensitic steel	1.2709	X3NiCoMoTi18-9-5	800-1000	X3NiCoMoTi18-9-5	
		1.4542	X5CrNiCuNb16-4		X5CrNiCuNb16-4	
		1.4568	X7CrNiAl17-7		X7CrNiAl17-7	
S	Titan-Legierungen, mittelfest	3.7164	TiAl6V4	-950	TiAl6V4	
		3.7115	TiAl5Sn2,5		TiAl5Sn2-5	
	Titan-Legierungen, hochfest	Titanium alloys, high strength	3.7174	TiAl6Sn2	900-1400	TiAl6V6Sn2
	Nickelbasis-Legierungen, mittelfest	Nickel based alloys, medium strength	2.4670	NiCr12Al6MoNb	-950	NiCr12Al6MoNb
	Nickelbasis-Legierungen, hochwarmfest	Heat resistant nickel based alloys, high strength	2.4668	NiCr19Fe19NbMo	900-1400	Inconel 718 NiCr19Fe19Nb5Mo3

Die angegebenen Schnittwerte sind Startwerte und müssen auf die vorhandenen Bedingungen abgestimmt werden.
The cutting data indicated are starting values and must be adjusted to the prevailing conditions.

	Kühlung Coolant	Schnittgeschwindigkeit Cutting speed v_c (m/min)	Fräserdurchmesser Cutting diameter (mm)			Schnitttiefe Cutting depth a_p (mm)
			Vorschub pro Zahn Feed per tooth f_z (mm/z.)			
			Ø 4-6	Ø 8-10	Ø 12-16	
		180	0,50	0,50	0,70	0,02 x d_1
		180	0,40	0,50	0,70	
		180	0,40	0,50	0,70	
		170	0,40	0,50	0,70	0,02 x d_1
		170	0,40	0,50	0,70	
		140	0,30	0,40	0,50	
		90	0,30	0,40	0,50	
		70	0,30	0,40	0,50	



Nassbearbeitung, auf ausreichende Emulsionszuführung achten
Wet machining, sufficient emulsion volume required

Der Hochvorschubfräser für gehärtete Stähle bis 65 HRC High Feed End Mills for Hardened Steels up to 65 HRC

Der neue HFC01 Rougher H wurde speziell für die Bearbeitung von ISO-H-Materialien entwickelt. Der Fräser weist eine maximale Zähnezahl (6–8) auf, die durch die Längen extra kurz, kurz und lang zu einem optimalen Programm ergänzt wird. Der Durchmesserbereich liegt hier bei 4–20 mm.

The new HFC01 Rougher H was specially developed for the machining of ISO-H materials. The end mill is equipped with a maximum amount of teeth (6–8) that, combined with the lengths extra short, short and long, form an ideal product range. The diameter range for these tools is 4–20 mm.

Merkmale:

Features:

Verlängerte Mantelschneide, nachschleifbar
Extended lateral cutting edge, regrindable

20°-Spiralwinkel
20° helix angle

Maximale
Zähnezahl
(z = 6–8)
Maximum
number of
teeth (z = 6–8)

Negative Schneidkanten­geometrie
Negative cutting edges

Schneidstoff LCHK20M
Cutting grade LCHK20M

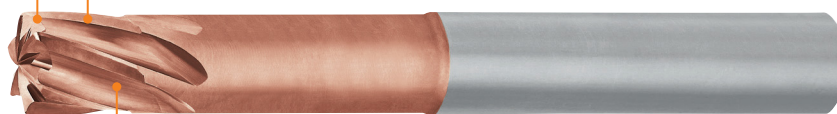
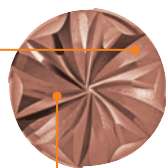

HFC01 Rougher H
Hochvorschubfräser für gehärtete Stähle bis 65 HRC
High feed end mills for hardened steels up to 65 HRC



DIN
6535
HA

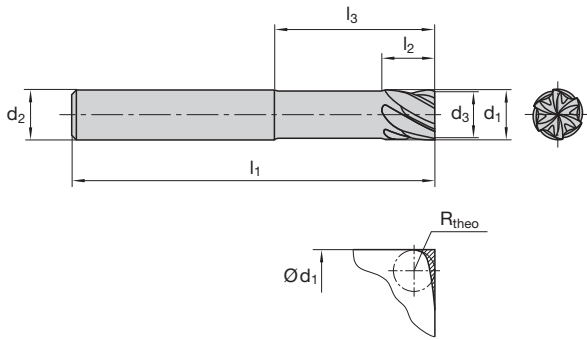

Katalog-Nr. Cat.-No.										HFC01-H-A	
P										<input type="checkbox"/>	
M											
K										<input type="checkbox"/>	
N											
S											
H										<input checked="" type="checkbox"/>	
d ₁	d ₃	l ₂	l ₁	l ₃	d ₂	z	R _{theo}	a _{p max}	Ident No.	LMT-Code	
extra kurz extra short											
4	3,8	4	57	9	6	6	0,4	0,2	7429966	EM-HFC01 H4.0x4/9 6R0.4HA	
5	4,8	5	57	11	6	6	0,5	0,25	7429967	EM-HFC01 H5.0x5/11 6R0.5HA	
6	5,7	6	57	13	6	6	0,6	0,3	7429968	EM-HFC01 H6.0x6/13 6R0.6HA	
8	7,6	8	63	17	8	6	0,8	0,4	7429969	EM-HFC01 H8.0x8/17 6R0.8HA	
10	9,5	10	72	22	10	6	1	0,5	7429970	EM-HFC01 H10.0x10/22 6R1.0HA	
12	11,5	12	83	26	12	6	1,2	0,6	7429971	EM-HFC01 H12.0x12/26 6R1.2HA	
16	15,5	16	92	34	16	8	1,6	0,8	7429972	EM-HFC01 H16.0x16/34 8R1.6HA	
20	19,5	20	104	42	20	8	2	1	7429973	EM-HFC01 H20.0x20/42 8R2.0HA	
kurz short											
4	3,8	4	57	15	6	6	0,4	0,2	7429974	EM-HFC01 H4.0x4/15 6R0.4HA	
5	4,8	5	57	16	6	6	0,5	0,25	7429975	EM-HFC01 H5.0x5/16 6R0.5HA	
6	5,7	6	57	19	6	6	0,6	0,3	7429976	EM-HFC01 H6.0x6/19 6R0.6HA	
8	7,6	8	63	25	8	6	0,8	0,4	7429977	EM-HFC01 H8.0x8/25 6R0.8HA	
10	9,5	10	72	32	10	6	1	0,5	7429978	EM-HFC01 H10.0x10/32 6R1.0HA	
12	11,5	12	83	38	12	6	1,2	0,6	7429979	EM-HFC01 H12.0x12/38 6R1.2HA	
16	15,5	16	100	50	16	8	1,6	0,8	7429980	EM-HFC01 H16.0x16/50 8R1.6HA	
20	19,5	20	114	62	20	8	2	1	7429981	EM-HFC01 H20.0x20/62 8R2.0HA	
lang long											
4	3,8	4	70	24	6	6	0,4	0,2	7429982	EM-HFC01 H4.0x4/24 6R0.4HA	
5	4,8	5	70	30	6	6	0,5	0,25	7429983	EM-HFC01 H5.0x6/30 6R0.5HA	
6	5,7	6	80	35	6	6	0,6	0,3	7429984	EM-HFC01 H6.0x6/35 6R0.6HA	
8	7,6	8	80	40	8	6	0,8	0,4	7429985	EM-HFC01 H8.0x8/40 6R0.8HA	
10	9,5	10	90	45	10	6	1	0,5	7429986	EM-HFC01 H10.0x10/45 6R1.0HA	
12	11,5	12	100	50	12	6	1,2	0,6	7429987	EM-HFC01 H12.0x12/50 6R1.2HA	
16	15,5	16	120	66	16	8	1,6	0,8	7429988	EM-HFC01 H16.0x16/66 8R1.6HA	
20	19,5	20	135	82	20	8	2	1	7429989	EM-HFC01 H20.0x20/82 8R2.0HA	

Schnittwertempfehlungen ab Seite 64
 Cutting data recommendations starting page 64

■ = Hauptanwendung First choice
 = Nebenanwendung Second choice

HFC01 Rougher H

Schnittwertempfehlungen

Cutting data recommendations

Werkstoff	Material	Werkstoff-Nr. Material No.	DIN Bezeichnung Alt DIN Description Old	R _m /UTS (N/mm ²)	DIN Bezeichnung Neu DIN Description New	
P	Vergütbare Formenstähle	1.2311	40CrMnMo7	-1100	40CrMnMo7	
		1.2312	40CrMnMoS8.6		40CrMnMoS8-6	
		1.2738	40CrMnNiMoS8.6.4		40CrMnNiMoS8-6-4	
		1.2711	54NiCrMoV6		54NiCrMoV6	
	Durchhärtende Werkzeugstähle	Full hardening tool steels	1.2343	X38CrMoV5 1	350-1400	X37CrMoV5 1
			1.2080	X210Cr12		X210Cr12
			1.2379	X155CrVMo12 1		X153CrVMo12 1
			1.2767	X45NiCrMo4		X45NiCrMo4
	Nitrierstähle	Nitriding steels	1.8550	34CrAlNi7	950-1400	34CrAlNi7
			1.8519	31CrMoV9		31CrMoV9
1.7735			14CrMoV6.9	14CrMoV6.9		
1.2344			X40CrMoV5.1	X40CrMoV5-1		
K	Grauguss	0.6025	GG25	100-400 (120-260 HB)	EN-GJI-250	
	Legierter Grauguss	0.6678	GGL-NiCr35 2	150-250 (160-230 HB)	EN-GJLA-XNiCr35-2	
	Sphäroguss	0.7060 0.7070	GGG60 GGG70L	400-800 (120-310 HB)	EN-GJS-600-3 EN-GJS-700-2U	
	Temperguss	0.8155	GTS55	350-700 (150-280 HB)	EN-GJMB-550-4	
H	Gehärteter Stahl			45-52 HRC		
				53-56 HRC		
				57-62 HRC		
				63-65 HRC		

Die angegebenen Schnittwerte sind Startwerte und müssen auf die vorhandenen Bedingungen abgestimmt werden.
The cutting data indicated are starting values and must be adjusted to the prevailing conditions.

Bei der langen Ausführung empfehlen wir die f_z -Werte um 30 % zu reduzieren.
We recommended to reduce the f_z -value with the long version by 30 %.

Anwendungsbeispiel

Application example

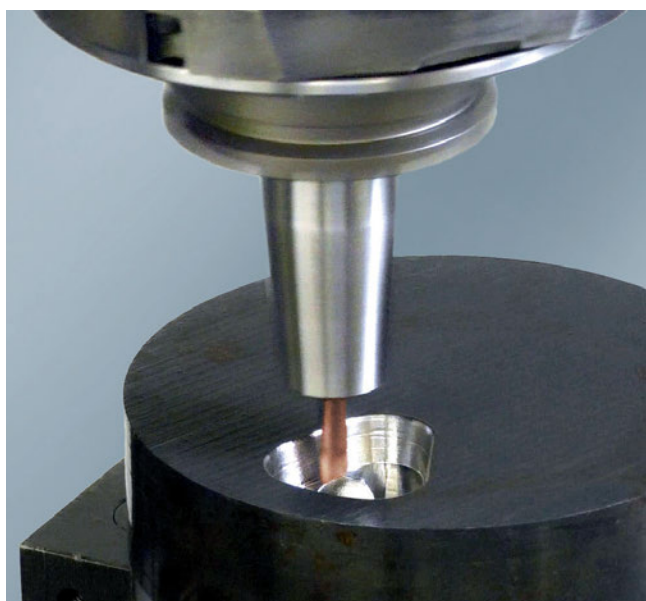

Kopierfräsen, Z-konstant
Copying, Z constant

Werkzeug Tool:
HFC H
 $d_1 = 6 \text{ mm}$, $z = 6$

Werkstoff Material:
Werkzeugstahl gehärtet,
Boehler W300 (1.2343 - X38CrMoV 5-1), H11, 54 HRC
Tool steel hardened,
Boehler W300 (1.2343 - X38CrMoV 5-1), H11, 54 HRC

Schnittwerte Cutting data:
 $v_c = 100 \text{ m/min}$
 $n = 5300 \text{ min}^{-1}$
 $f_z = 0,175 \text{ mm}$
 $v_f = 5600 \text{ mm/min}$
 $a_e = 3,5 \text{ mm}$
 $a_p = 0,2 \text{ mm}$

	Schnittgeschwindigkeit Cutting speed v_c (m/min)	Fräserdurchmesser Cutting diameter (mm)						Schnitttiefe Cutting depth a_p (mm)
		Vorschub pro Zahn Feed per tooth f_z (mm/z.)						
		Ø 4	Ø 5	Ø 6	Ø 8	Ø 10	Ø 12-20	
	240	0,30	0,38	0,45	0,60	0,75	0,90	0,05 x d_1 (= $a_{p \max}$)
	220	0,30	0,38	0,45	0,60	0,75	0,90	0,04 x d_1
	200	0,24	0,30	0,36	0,48	0,60	0,70	
	200	0,28	0,35	0,42	0,56	0,70	0,85	0,04 x d_1
	180	0,26	0,33	0,39	0,52	0,65	0,80	
	160	0,24	0,30	0,36	0,48	0,60	0,70	0,04 x d_1
	200	0,28	0,35	0,42	0,56	0,70	0,85	
	180	0,26	0,33	0,39	0,52	0,65	0,80	
	160	0,24	0,30	0,36	0,48	0,60	0,70	0,05 x d_1
	200	0,35	0,40	0,55	0,65	0,80	0,95	
	180	0,30	0,35	0,50	0,60	0,75	0,90	
	180	0,30	0,35	0,50	0,60	0,75	0,90	
	160	0,30	0,35	0,50	0,60	0,75	0,90	0,04 x d_1
	160-180	0,16	0,20	0,24	0,32	0,40	0,48	
	120-160	0,12	0,15	0,18	0,24	0,30	0,36	
	100-120	0,08	0,10	0,12	0,16	0,20	0,24	
	80-100	0,06	0,08	0,09	0,12	0,15	0,18	0,01 x d_1

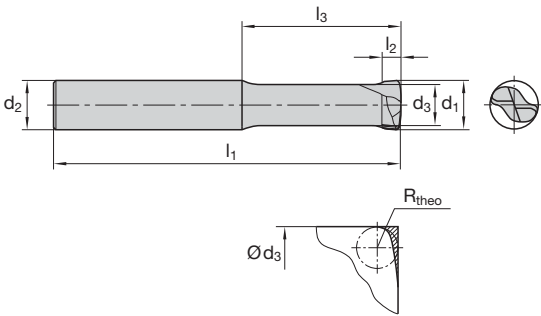

Katalog-Nr. Cat.-No.										HFC01-U-A	
P										■	
M										■	
K										■	
N											
S											
H										□	
d ₁	d ₃	l ₂	l ₁	l ₃	d ₂	z	R _{theo}	a _{p max}	Ident No.	LMT-Code	
extra kurz extra short											
1	0,8	0,35	40	2	3	2	0,1	0,05	7422488	EM-HFC01 U1.0x0.35/2 2R0.1HA	
2	1,6	0,7	40	4	4	2	0,2	0,1	7422489	EM-HFC01 U2.0x0.7/4 2R0.2HA	
3	2,5	1	50	6	6	2	0,3	0,15	7422490	EM-HFC01 U3.0x1/6 2R0.3HA	
4	3,4	1,5	57	8	6	2	0,4	0,2	7422494	EM-HFC01 U4.0x1.5/8 2R0.4HA	
5	4,2	2	57	10	6	2	0,5	0,25	7422495	EM-HFC01 U5.0x2/10 2R0.5HA	
6	5	2,5	57	12	6	2	0,6	0,3	7422496	EM-HFC01 U6.0x2.5/12 2R0.6HA	
8	6,7	3	63	16	8	2	0,8	0,4	7422497	EM-HFC01 U8.0x3/16 2R0.8HA	
10	8,5	3,5	72	20	10	2	1	0,5	7422498	EM-HFC01 U10.0x3.5/20 2R1.0HA	
12	10	4	83	24	12	2	1,2	0,6	7422499	EM-HFC01 U12.0x4/24 2R1.2HA	
14	11,8	4	83	28	14	2	1,4	0,7	7422500	EM-HFC01 U14.0x4/28 2R1.4HA	
kurz short											
1	0,8	0,35	40	4	3	2	0,1	0,05	7422491	EM-HFC01 U1.0x0.35/4 2R0.1HA	
2	1,6	0,7	40	8	4	2	0,2	0,1	7422492	EM-HFC01 U2.0x0.7/8 2R0.2HA	
3	2,5	1	57	12	6	2	0,3	0,15	7422493	EM-HFC01 U3.0x1/12 2R0.3HA	
4	3,4	1,5	57	15	6	2	0,4	0,2	7422466	EM-HFC01 U4.0x1.5/15 2R0.4HA	
5	4,2	2	57	17,5	6	2	0,5	0,25	7422467	EM-HFC01 U5.0x2/17.5 2R0.5HA	
6	5	2,5	57	19	6	2	0,6	0,3	7422468	EM-HFC01 U6.0x2.5/19 2R0.6HA	
8	6,7	3	63	24	8	2	0,8	0,4	7422469	EM-HFC01 U8.0x3/24 2R0.8HA	
10	8,5	3,5	72	28,5	10	2	1	0,5	7422470	EM-HFC01 U10.0x3.5/28.5 2R1.0HA	
12	10	4	83	34	12	2	1,2	0,6	7422471	EM-HFC01 U12.0x4/34 2R1.2HA	
16	13,5	5,5	92	39	16	2	1,6	0,8	7422472	EM-HFC01 U16.0x5.5/39 2R1.6HA	
20	17	7	104	48	20	2	2	1	7422473	EM-HFC01 U20.0x7/48 2R2.0HA	
lang long											
4	3,4	1,5	70	24	6	2	0,4	0,2	7422482	EM-HFC01 U4.0x1.5/24 2R0.4HA	
5	4,2	2	70	30	6	2	0,5	0,25	7422483	EM-HFC01 U5.0x2/30 2R0.5HA	
6	5	2,5	80	35	6	2	0,6	0,3	7422484	EM-HFC01 U6.0x2.5/35 2R0.6HA	
8	6,7	3	80	40	8	2	0,8	0,4	7422485	EM-HFC01 U8.0x3/40 2R0.8HA	
10	8,5	3,5	90	45	10	2	1	0,5	7422486	EM-HFC01 U10.0x3.5/45 2R1.0HA	
12	10	4	100	50	12	2	1,2	0,6	7422487	EM-HFC01 U12.0x4/50 2R1.2HA	

Schnittwertempfehlungen ab Seite 68
 Cutting data recommendations starting page 68

■ = Hauptanwendung First choice
 □ = Nebenanwendung Second choice



DIN
6535
HA

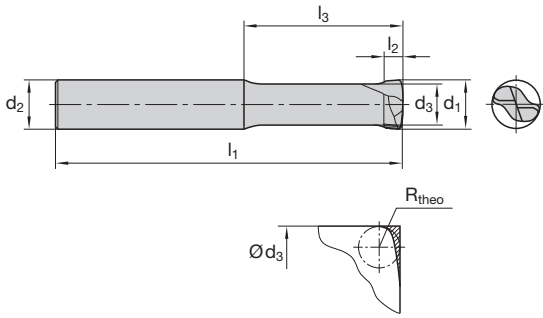

Katalog-Nr. Cat.-No.										HFC01-U-A	
P										■	
M										■	
K										■	
N											
S											
H										□	
d ₁	d ₃	l ₂	l ₁	l ₃	d ₂	z	R _{theo}	a _{p max}	Ident No.	LMT-Code	
extra lang extra long											
4	3,4	1,5	80	34	6	2	0,4	0,2	7422474	EM-HFC01 U4.0x1.5/34 2R0.4HA	
5	4,2	2	80	37	6	2	0,5	0,25	7422475	EM-HFC01 U5.0x2/37 2R0.5HA	
6	5	2,5	80	42	6	2	0,6	0,3	7422476	EM-HFC01 U6.0x2.5/42 2R0.6HA	
8	6,7	3	90	51	8	2	0,8	0,4	7422477	EM-HFC01 U8.0x3/51 2R0.8HA	
10	8,5	3,5	100	56,5	10	2	1	0,5	7422478	EM-HFC01 U10.0x3.5/56.5 2R1.0HA	
12	10	4	110	61	12	2	1,2	0,6	7422479	EM-HFC01 U12.0x4/61 2R1.2HA	
16	13,5	5,5	130	77	16	2	1,6	0,8	7422480	EM-HFC01 U16.0x5.5/77 2R1.6HA	
20	17	7	150	94	20	2	2	1	7422481	EM-HFC01 U20.0x7/94 2R2.0HA	

Schnittwertempfehlungen ab Seite 68
 Cutting data recommendations starting page 68

■ = Hauptanwendung First choice
 □ = Nebenanwendung Second choice

HFC01 Rougher UNI
Schnittwertempfehlungen
Cutting data recommendations

Werkstoff	Material	Werkstoff-Nr. Material No.	DIN Bezeichnung Alt DIN Description Old	R_m/UTS (N/mm²)	DIN Bezeichnung Neu DIN Description New	
P	Unlegierter Baustahl + Automatenstahl	1.0570	St52-3	-700	S355J2G3	
		1.1730	C45	-800	C45U	
		1.0715	9SMn28	-700	11SMn30	
		1.1191	Ck45	500-950	C45E	
	Vergütungsstahl, mittelfest	Heat-treatment steel, medium strength	1.7219	26CrMo4		26CrMo4-2
			1.7225	42CrMo4	500-950	42CrMo4
	Stahlguss	Cast steel	1.8159	51CrV4		51CrV4
			1.0416	GS40	-950	GS40
	Einsatzstahl	Case hardening steel	1.7131	16MnCr5	-950	16MnCr5
	Rost- und säurebeständiger Stahl, ferritisch, martensitisch	Stainless steel, ferritic, martensitic	1.4006	X10Cr13	500-950	X12Cr13
			1.4104	X12CrMoS17		X14CrMoS17
			1.4122	X35CrMo17		X39CrMo17-1
	Vergütungsstahl, hochfest	Heat-treatment steel, high strength	1.7225	42CrMo4	950-1400	42CrMo4
			1.6580	30CrNiMo8		30CrNiMo8
	Nitrierstahl, vergütet	Nitriding steel, heat treated	1.8504	34CrAl6	950-1400	34CrAl6
			1.2344	X40CrMoV5.1	-900	X40CrMoV5-1
Werkzeugstahl	Tool steel	1.2343	X38CrMoV5 1	950-1400	X37CrMoV5-1	
		1.2316	X38CrMo16	-1100	X38CrMo16	
		1.2379	X155CrVMo12 1	-950	X153CrMoV12-1	
		1.2080	X210Cr12	950-1400	X210Cr12	
		1.2358	60CrMoV18-5	850-1000	60CrMoV18-5	
		1.2714	55NiCrMoV7	1100-1350	55NiCrMoV7	
		1.2311	40CrMnMo7	-1100	40CrMnMo7	
M	Rost- und säurebeständiger Stahl, austenitisch	1.2312	40CrMnNiMoS8.6	-1150	40CrMnNiMoS8-6	
		1.2738	45CrMnNiMo8.6.4	950-1150	45CrMnNiMo8-6-4	
		1.4301	X2CrNiMo17-12-2	500-950	X5CrNiMo18-10	
	Rost- und säurebeständiger Stahl, austenitisch	Stainless steel, austenitic	1.4404	X6CrNiMoTi17-12-2		X2CrNiMo17-12-2
			1.4571	X10CrNiMoTi18		X10CrNiMoTi18
K	Grauguss	Grey cast iron	GG25	1.2709	X3NiCoMoTi18-9-5	
				1.4542	X5CrNiCuNb16-4	
				1.4568	X7CrNiAl17-7	
K	Legierter Grauguss	Alloyed grey cast iron	GGL-NiCr35 2	800-1000	X3NiCoMoTi18-9-5	
					X5CrNiCuNb16-4	
					X7CrNiAl17-7	
K	Sphäroguss	Nodular cast iron	GGG70L	100-400 (120-260 HB)	EN-GJI-250	
				400-800 (120-310 HB)	EN-GJS-700-2U	
K	Temperguss	Malleable cast iron	GGS60	150-250 (160-230 HB)	EN-GJLA-XNiCr35-2	
				350-700 (150-280 HB)	EN-GJS-600-3	
H	Hartguss	Chilled cast iron	Ni-hard, Ampco	350-700 (150-280 HB)	EN-GJMB-550-4	
				300-600 HB	Ni-hard, Ampco	
H	Gehärteter Stahl	Hardened steel		45-52 HRC		

Die angegebenen Schnittwerte sind Startwerte bezogen auf Ø 10 mm und müssen auf die vorhandenen Bedingungen abgestimmt werden.
The cutting data indicated are starting values based on Ø 10 mm and must be adjusted to the prevailing conditions.

Bei der langen Ausführung empfehlen wir die f_z-Werte um 30% zu reduzieren.
We recommended to reduce the f_z-value with the long version by 30 %.

	Schnittgeschwindigkeit Cutting speed v_c (m/min)	Fräserdurchmesser Cutting diameter (mm)			Schnitttiefe Cutting depth a_p (mm)
		Vorschub pro Zahn Feed per tooth f_z (mm/z.)			
		Ø 1-4	Ø 5-10	Ø 12-20	
	300	0,30	0,70	1,00	0,05 x d_1
	300	0,30	0,70	1,00	
	300	0,30	0,70	1,00	
	240	0,25	0,60	0,80	
	200	0,25	0,60	0,80	
	240	0,25	0,60	0,80	
	200	0,25	0,60	0,80	0,045 x d_1
	200	0,25	0,60	0,80	
	180	0,25	0,60	0,80	
	220	0,25	0,60	0,80	
	200	0,20	0,50	0,70	0,04 x d_1
	200	0,25	0,60	0,80	
	230	0,20	0,50	0,70	0,02 x d_1
	230	0,20	0,50	0,70	
	250	0,50	0,90	1,30	0,04 x d_1
	250	0,45	0,80	1,20	
	180	0,20	0,50	0,70	
	180	0,30	0,70	1,00	
	150	0,30	0,70	1,00	
	100	0,20	0,50	0,70	0,03 x d_1
	160-180	0,15	0,30	0,50	

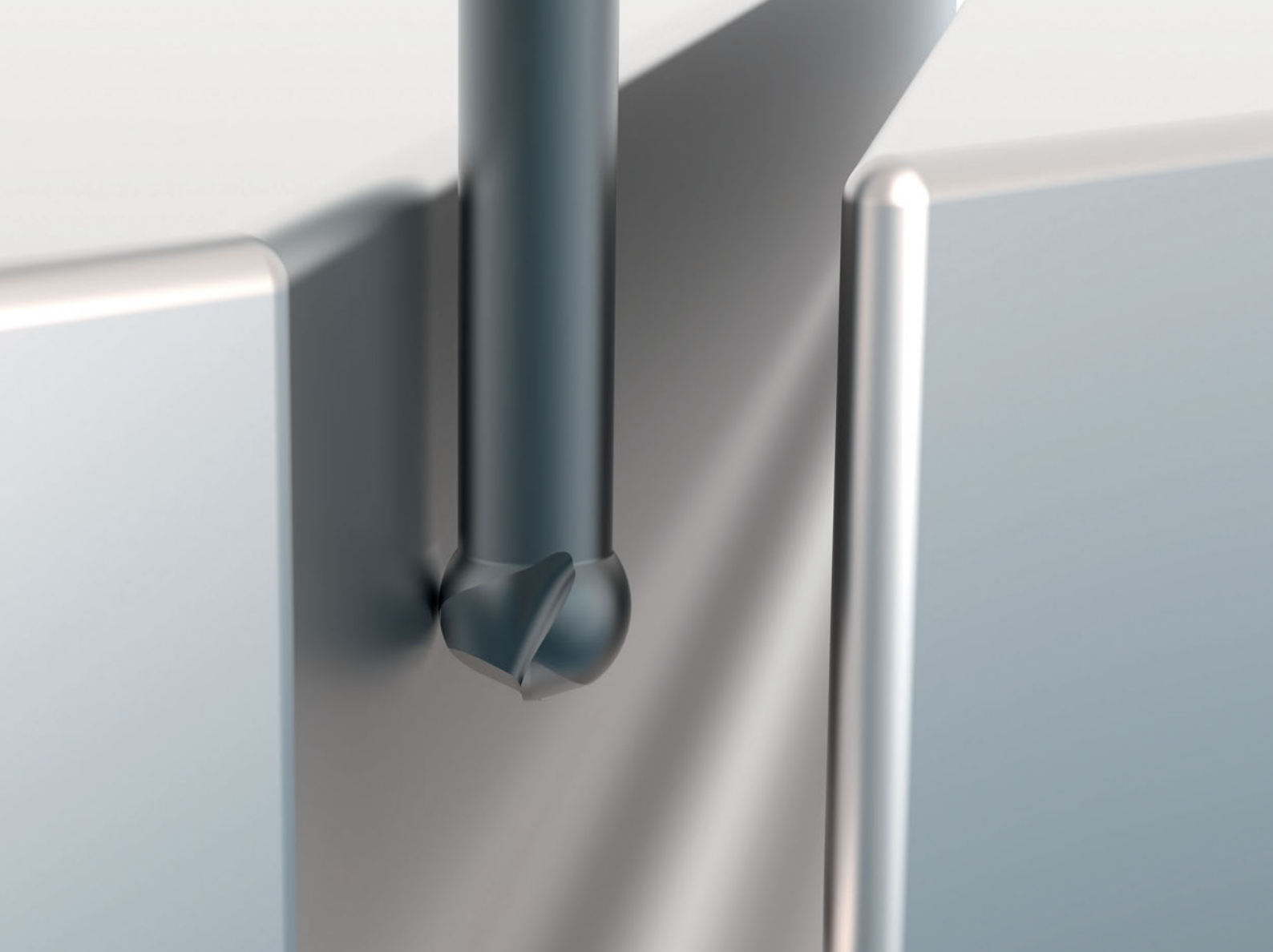

HSC – High Speed Cutter

Unsere Komplettlösung
für Ihre anspruchsvollsten
Fräsprozesse

Our Complete Solution
for Your Most Demanding
Milling Processes

Mit unserem HSC-Programm sind wir stolz darauf, Ihnen eine breite Palette von Spezialisten für Ihre anspruchsvollsten fünfachsigen Bearbeitungsaufgaben anzubieten. Dank unserer Expertise im Schlichten und der Bereitstellung von erstklassigen Oberflächengüten, setzen unsere Werkzeuge neue Maßstäbe. Egal ob konvex oder konkav – unsere Auswahl an runden und torischen Geometrien ermöglicht eine perfekte Bearbeitung der jeweiligen Oberflächen.

Des Weiteren haben Sie in unserem Programm eine Vielzahl an Optionen. So maximieren unter anderem verlängerte Hälse und optimierte Schneidstoffe Ihre Produktivität und die Ergebnisse Ihrer Bauteile in verschiedenen Werkstückmaterialien. Ob es sich um harte oder langspanende Materialien handelt, wir haben die perfekte Lösung für Sie. Dank unserer langjährigen Erfahrung im Gesenk- und Formenbau wissen wir genau, worauf es ankommt. Wir von LMT Tools sind der verlässliche Partner an Ihrer Seite und wissen mit unseren Werkzeugen, Ihre Erwartungen zu übertreffen. Entdecken Sie die grenzenlosen Möglichkeiten mit unserem HSC-Programm!

Unsere Komplettlösung für das beste Ergebnis in Ihrer Fertigung **Our Complete Solution for the Best Result in Your Production**

Das besondere Highlight an unserem HSC-Programm? Unser ergänzendes Kopierfräsprogramm im Wendepaltenbereich bietet Ihnen eine vollständige Werkzeug-Palette aus einer Hand. So müssen Sie nicht länger verschiedene Lieferanten koordinieren oder Kompromisse bei der Qualität eingehen. Wir bieten Ihnen alles, was Sie benötigen, um Ihre Fertigungsprozesse zu optimieren und effizienter zu gestalten.

Warten Sie nicht länger und treten Sie ein in die Welt unseres HSC-Programms. Erleben Sie Perfektion durch unsere langjährige Erfahrung und unseren unermüdlichen Einsatz für Qualität. Kontaktieren Sie uns noch heute und lassen Sie uns gemeinsam Ihre Bearbeitungsaufgaben auf ein neues Niveau heben!

Ihre Vorteile:

- Sehr gute Oberflächenqualität der bearbeiteten Werkstücke
- Optimierte Geometrie mit sehr engen Fertigungstoleranzen für höchste Präzision im Einsatz
- Hochwertige Substrate für hohe Schnittgeschwindigkeiten und kürzere Bearbeitungszeiten
- Ausgereifte Beschichtung mit hoher Verschleißbeständigkeit für stabile Fertigungsprozesse

With our HSC program, we are proud to offer you a wide range of specialists for your most demanding five-axis machining tasks. Thanks to our expertise in finishing and providing first-class surface finishes, our tools set new standards. Whether convex or concave, our selection of geometries enables perfect machining of the respective surfaces. You have a wide range of options in our program.

Among other things, extended necks and optimized cutting materials maximize your productivity and the results of your components in various workpiece materials. Whether your material is hard or long-chipping, we have the perfect solution for you. Thanks to our many years of experience in die and mold making, we know exactly what matters. We at LMT Tools are the reliable partner at your side and know how to exceed your expectations with our tools. Discover unlimited possibilities with our HSC program!

The special highlight of our HSC program? Our copy milling program in the insert area offers you a complete range of tools from a single source. This means you no longer have to coordinate different suppliers or compromise on quality. We offer you everything you need to optimize your machining processes and make them more efficient.

Don't wait any longer and enter the world of our HSC program. Experience perfection through our years of experience and unwavering commitment to quality. Contact us today and let's work together to take your machining tasks to the next level!

Your benefits:

- Very good surface quality of the machined workpieces
- Optimized geometry with very tight manufacturing tolerances for maximum precision in use
- High-quality substrate for high cutting speeds and shorter machining times
- Advanced coating with high wear resistance for stable manufacturing processes

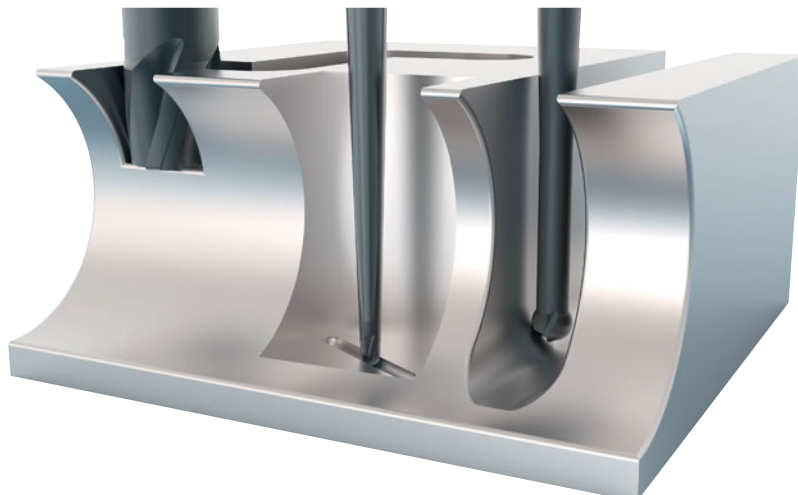

HSC01 Finisher 50 H | Toric-Finisher 30 H | Finisher 30 H
Eigenschaften auf einen Blick
Features at a glance

Schneidenlänge $2 \times d_1$ und $3 \times d_1$
 Cutting length $2 \times d_1$ and $3 \times d_1$



Schaft nach
 DIN 6535 HA
 Shank according
 DIN 6535 HA

2 und 4 Schneiden mit Eckenradius
 2 and 4 flutes with corner radius



Halsgestaltung für Formauszugsschrägen
 Neck design for form draft angles

Halslänge bis $10 \times d_1$
 Neck length up to $10 \times d_1$



Definiert behandelte Schneidkante
 Defined preparation of the cutting edge

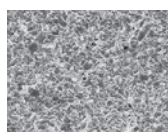

Innovativer Schneidstoff (LCHK20M)
 Innovative cutting material (LCHK20M)

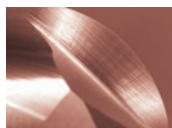

Sehr eng tolerierter Radius $\pm 0,005$ mm
 Very closely tolerated radius ± 0.005 mm

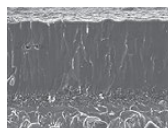

Leistungsstarke Mehrlagenbeschichtung
 High-performance multi-layer coating

HSC01 Finisher 50 H
Schafffräser, hochgedrallt mit Kantenschutzfase
End mills, high helix angle with edge protection chamfer

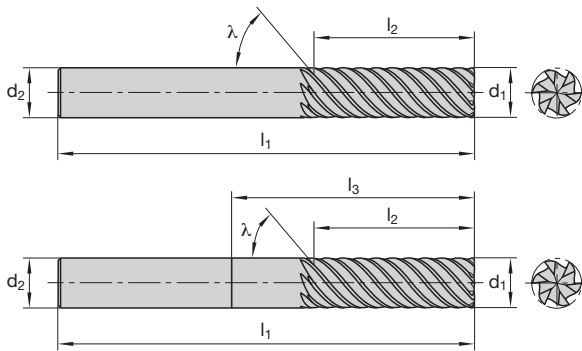
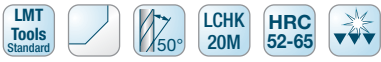

Katalog-Nr. Cat.-No.							HSC01-H-A	
P							<input type="checkbox"/>	
M								
K							<input type="checkbox"/>	
N								
S								
H							<input checked="" type="checkbox"/>	
d₁								
Ø 4-6	0 -0,038							
Ø 8-20	0 -0,047	l₂	l₁	l₃	d₂	z	Ident No.	LMT-Code
lang long								
4		14	57	-	6	4	7440204	EM-HSC01 H4.0x14/14 4C0.05HA
5		17	65	-	6	4	7440205	EM-HSC01 H5.0x17/17 4C0.05HA
6		20	65	-	6	6	7440206	EM-HSC01 H6.0x20/20 6C0.05HA
8		26	75	-	8	6	7440207	EM-HSC01 H8.0x26/26 6C0.05HA
10		32	90	-	10	6	7440208	EM-HSC01 H10.0x32/32 6C0.05HA
12		38	100	-	12	8	7440209	EM-HSC01 H12.0x38/38 8C0.1HA
16		50	120	-	16	8	7440210	EM-HSC01 H16.0x50/50 8C0.1HA
20		62	135	-	20	8	7440211	EM-HSC01 H20.0x62/62 8C0.1HA
extra lang extra long								
6		12	80	44	6	6	7440212	EM-HSC01 H6.0x12/44 6C0.05HA
8		16	100	64	8	6	7440213	EM-HSC01 H8.0x16/64 6C0.05HA
10		20	100	60	10	6	7440214	EM-HSC01 H10.0x20/60 6C0.05HA
12		24	120	75	12	8	7440215	EM-HSC01 H12.0x24/75 8C0.1HA
16		32	150	102	16	8	7440216	EM-HSC01 H16.0x32/102 8C0.1HA

■ = Hauptanwendung First choice
 = Nebenanwendung Second choice

Schnittwertempfehlungen ab Seite 76
 Cutting data recommendations starting page 76

Kantenschutzfase Edge protection chamfer	d ₁	b
	4 - 10	0,05
	12 - 20	0,1

HSC01 Finisher 50 H
Schafffräser, hochgedrallt mit Eckenradius
End mills, high helix angle with corner radius

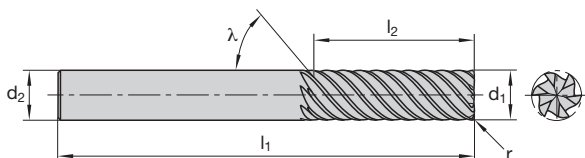
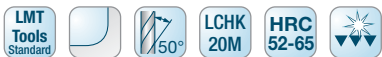

Katalog-Nr. Cat.-No.		HSC-H-A					
P		<input type="checkbox"/>					
M							
K		<input type="checkbox"/>					
N							
S							
H		<input checked="" type="checkbox"/>					
d₁ 0 Ø4-6 -0,038 0 Ø8-20 -0,047	l₂	l₁	d₂	z	r ±0,015	Ident No.	LMT-Code
lang long							
4	14	57	6	4	0,5	7440217	EM-HSC01 H4.0x14/14 4R0.5HA
4	14	57	6	4	1	7440218	EM-HSC01 H4.0x14/14 4R1.0HA
5	17	65	6	4	0,5	7440219	EM-HSC01 H5.0x17/17 4R0.5HA
5	17	65	6	4	1	7440220	EM-HSC01 H5.0x17/17 4R1.0HA
6	20	65	6	6	0,5	7440221	EM-HSC01 H6.0x20/20 6R0.5HA
6	20	65	6	6	1	7440222	EM-HSC01 H6.0x20/20 6R1.0HA
8	26	75	8	6	0,5	7440223	EM-HSC01 H8.0x26/26 6R0.5HA
8	26	75	8	6	1	7440224	EM-HSC01 H8.0x26/26 6R1.0HA
8	26	75	8	6	2	7440225	EM-HSC01 H8.0x26/26 6R2.0HA
10	32	90	10	6	0,5	7440226	EM-HSC01 H10.0x32/32 6R0.5HA
10	32	90	10	6	1	7440227	EM-HSC01 H10.0x32/32 6R1.0HA
10	32	90	10	6	2	7440228	EM-HSC01 H10.0x32/32 6R2.0HA
12	38	100	12	8	0,5	7440229	EM-HSC01 H12.0x38/38 8R0.5HA
12	38	100	12	8	1	7440230	EM-HSC01 H12.0x38/38 8R1.0HA
12	38	100	12	8	2	7440231	EM-HSC01 H12.0x38/38 8R2.0HA
16	50	120	16	8	0,5	7440232	EM-HSC01 H16.0x50/50 8R0.5HA
16	50	120	16	8	1	7440233	EM-HSC01 H16.0x50/50 8R1.0HA
16	50	120	16	8	2	7440234	EM-HSC01 H16.0x50/50 8R2.0HA
20	62	135	20	8	0,5	7440235	EM-HSC01 H20.0x62/62 8R0.5HA
20	62	135	20	8	1	7440236	EM-HSC01 H20.0x62/62 8R1.0HA
20	62	135	20	8	2	7440237	EM-HSC01 H20.0x62/62 8R2.0HA

Schnittwertempfehlungen ab Seite 76
 Cutting data recommendations starting page 76

■ = Hauptanwendung First choice
 □ = Nebenanwendung Second choice

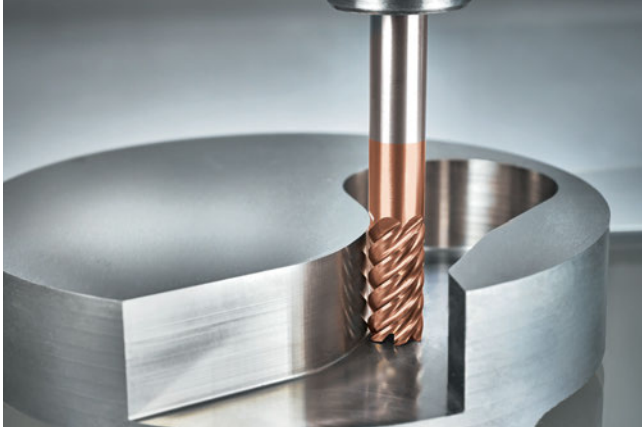

Labortest: Besäumen / Zeilenfräsen
Laboratory test, contour milling / traverse milling

Werkzeug Tool:
HSC01 Finisher 50 H
EM-HSC01 H12.0x38/38 8C0.1HA (Ident No. 7440209)
 $d_1 = 12 \text{ mm}$, $z = 8$

Schneidstoff Cutting material:
LCHK20M

Werkstoff Material:
X155CrMoV12-1, 1.2379 (61 HRC)

Schnittwerte Cutting data:

$v_c = 120 \text{ m/min}$
 $n = 3200 \text{ min}^{-1}$
 $f_z = 0,05 \text{ mm}$
 $v_f = 1280 \text{ mm/min}$
 $a_e = 0,12 \text{ mm}$
 $a_p = 24 \text{ mm}$

Ergebnis Result:

Der Standweg konnte bei unserem Werkzeug im Vergleich zum besten Wettbewerber mehr als verdoppelt werden.

The tool life was doubled with our tool comparing to the best competitor at this point.

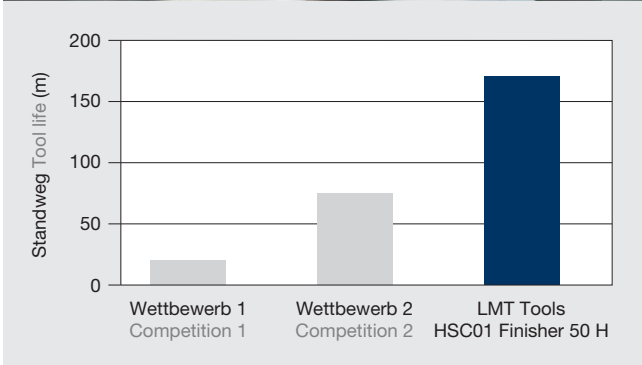

HSC01 Finisher 50 H

Schnittwertempfehlungen für hochgedrallte Schafffräser mit Eckenradius und Kantenschutzfase

Cutting data recommendations for high helix end mills with corner radius and edge protection chamfer

Werkstoff		Material	Werkstoff-Nr. Material No.	DIN Bezeichnung Alt DIN Description Old	Härte Hardness	DIN Bezeichnung Neu DIN Description New
P	Vergütbare Formenstähle	Heat-treatable die steels	1.2311	40CrMnMo7	280–325 HB	40CrMnMo7
			1.2312	40CrMnMoS8.6	280–325 HB	40CrMnMoS8-6
			1.2738	40CrMnNiMoS8.6.4	280–325 HB	40CrMnNiMoS8-6-4
			1.2711	54NiCrMoV6	280–415 HB	54NiCrMoV6
	Durchhärtende Werkzeugstähle	Full hardening tools steels	1.2343	X38CrMoV5 1	230 HB	X37CrMoV5 1
			1.2080	X210Cr12	250 HB	X210Cr12
			1.2379	X155CrVMo12 1	250 HB	X153CrVMo12 1
			1.2767	X45NiCrMo4	260 HB	X45NiCrMo4
	Nitrierstähle	Nitriding steels	1.8550	34CrAlNi7	240–300 HB	34CrAlNi7
			1.8519	31CrMoV9	265–310 HB	31CrMoV9
			1.7735	14CrMoV6.9	265–310 HB	14CrMoV6.9
			1.2344	X40CrMoV5.1	280–325 HB	X40CrMoV5-1
K	Grauguss	Grey cast iron	0.6025	GG25	100–400 (120–260 HB)	EN-GJl-250
	Legierter Grauguss	Alloyed grey cast iron	0.6678	GGL-NiCr35 2	150–250 (160–230 HB)	EN-GJLA-XNiCr35-2
	Sphäroguss	Nodular cast iron	0.7060 0.7070	GGG60 GGG70L	400–800 (120–310 HB)	EN-GJS-600-3 EN-GJS-700-2U
	Temperguss	Malleable cast iron	0.8155	GTS55	350–700 (150–280 HB)	EN-GJMB-550-4
H	Gehärteter Stahl	Hardened steel			45–52 HRC	
					53–56 HRC	
					57–62 HRC	
					63–65 HRC	

Die angegebenen Schnittwerte sind Startwerte und müssen auf die vorhandenen Bedingungen abgestimmt werden.

The cutting data specified represents base values and must be adapted to the existing conditions.

Bei der langen Ausführung empfehlen wir die f_z -Werte um 30 % zu reduzieren.

For high values of total feed we recommend reducing the specified unit values of feed (f_z) by 30 %.

	Schnitt- geschwindigkeit Cutting speed v_c (m/min)	Fräserdurchmesser Cutting diameter (mm)								Schnitttiefe Cutting depth a_e (mm)
		Vorschub pro Zahn Feed per tooth f_z (mm/z.)								
		4	5	6	8	10	12	16	20	
	200	0,02	0,03	0,03	0,04	0,05	0,06	0,08	0,09	0,08 x d_1
	220	0,02	0,03	0,03	0,04	0,05	0,06	0,08	0,09	
	180	0,01	0,02	0,02	0,02	0,03	0,04	0,05	0,05	
	200	0,02	0,02	0,02	0,03	0,04	0,05	0,06	0,07	0,06 x d_1
	200	0,02	0,03	0,03	0,04	0,05	0,06	0,07	0,09	
	160	0,01	0,02	0,02	0,02	0,03	0,04	0,04	0,05	
	160	0,01	0,02	0,02	0,02	0,03	0,04	0,04	0,05	0,08 x d_1
	200	0,02	0,02	0,02	0,03	0,04	0,05	0,06	0,07	
	180	0,01	0,02	0,02	0,02	0,03	0,04	0,05	0,05	
	200	0,01	0,02	0,02	0,02	0,03	0,04	0,05	0,05	0,08 x d_1
	200	0,02	0,02	0,02	0,03	0,04	0,05	0,06	0,07	
	200	0,02	0,03	0,03	0,04	0,05	0,06	0,07	0,09	
	240	0,03	0,04	0,05	0,06	0,07	0,09	0,10	0,11	0,06 x d_1
	220	0,02	0,03	0,04	0,05	0,06	0,07	0,08	0,09	
	220	0,02	0,03	0,04	0,05	0,06	0,07	0,08	0,09	
	200	0,02	0,03	0,04	0,05	0,06	0,07	0,07	0,08	
	180	0,01	0,02	0,02	0,02	0,03	0,04	0,05	0,05	0,04 x d_1
	150	0,01	0,01	0,02	0,02	0,03	0,03	0,05	0,05	0,03 x d_1
	120	0,01	0,01	0,02	0,02	0,03	0,03	0,04	0,05	0,02 x d_1
	100	0,01	0,01	0,01	0,02	0,02	0,03	0,04	0,04	0,01 x d_1

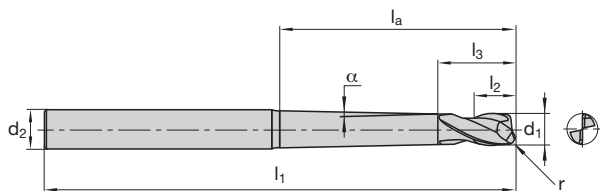

Katalog-Nr. Cat.-No.		HSC01-H-A									
P		<input type="checkbox"/>									
M											
K		<input type="checkbox"/>									
N											
S											
H		<input checked="" type="checkbox"/>									
d ₁ 0 -0,015	l ₂	l ₁	l ₃	l _a	α 0 -0,2°	d ₂	z	r ±0,01	Ident No.	LMT-Code	
lang long											
1	1	60	3	10	0,9	4	2	0,1	7439642	EM-HSC01 H1.0x1/3/10 2R0.1HA	
1,5	1,5	60	4,5	16	1,5	4	2	0,25	7439643	EM-HSC01 H1.5x1.5/4.5/16 2R0.25HA	
2	2	60	6	20	0,9	4	2	0,5	7439644	EM-HSC01 H2.0x2/6/20 2R0.5HA	
3	3	80	8	40	0,9	6	2	0,1	7439645	EM-HSC01 H3.0x3/8/40 2R0.1HA	
3	3	80	8	40	0,9	6	2	0,5	7439646	EM-HSC01 H3.0x3/8/40 2R0.5HA	
3	3	80	8	40	0,9	6	2	1	7439647	EM-HSC01 H3.0x3/8/40 2R1.0HA	
4	4	80	10	40	0,9	6	2	0,5	7439648	EM-HSC01 H4.0x4/10/40 2R0.5HA	
4	4	80	10	40	0,9	6	2	1	7439649	EM-HSC01 H4.0x4/10/40 2R1.0HA	
6	6	80	15	40	0,9	8	2	0,5	7439650	EM-HSC01 H6.0x6/15/40 2R0.5HA	
6	6	80	15	40	0,9	8	2	1	7439651	EM-HSC01 H6.0x6/15/40 2R1.0HA	
6	6	80	15	40	0,9	8	2	1,5	7439652	EM-HSC01 H6.0x6/15/40 2R1.5HA	
6	6	80	15	40	0,9	8	2	2	7439653	EM-HSC01 H6.0x6/15/40 2R2.0HA	
8	8	100	20	50	0,9	10	2	0,5	7439654	EM-HSC01 H8.0x8/20/50 2R0.5HA	
8	8	100	20	50	0,9	10	2	1	7439655	EM-HSC01 H8.0x8/20/50 2R1.0HA	
8	8	100	20	50	0,9	10	2	2	7439656	EM-HSC01 H8.0x8/20/50 2R2.0HA	
10	10	120	30	70	0,9	12	2	0,5	7439657	EM-HSC01 H10.0x10/30/70 2R0.5HA	
10	10	120	30	70	0,9	12	2	1	7439658	EM-HSC01 H10.0x10/30/70 2R1.0HA	
10	10	120	30	70	0,9	12	2	2	7439659	EM-HSC01 H10.0x10/30/70 2R2.0HA	
extra lang extra long											
1	1	60	3	15	0,4	4	2	0,1	7439660	EM-HSC01 H1.0x1/3/15 2R0.1HA	
2	2	100	6	60	0,9	4	2	0,5	7439661	EM-HSC01 H2.0x2/6/60 2R0.5HA	
3	3	100	8	60	1,3	6	2	0,1	7439662	EM-HSC01 H3.0x3/8/60 2R0.1HA	
3	3	100	8	60	1,3	6	2	0,5	7439663	EM-HSC01 H3.0x3/8/60 2R0.5HA	
3	3	100	8	60	1,3	6	2	1	7439664	EM-HSC01 H3.0x3/8/60 2R1.0HA	
6	6	100	15	50	1,2	8	2	0,5	7439665	EM-HSC01 H6.0x6/15/50 2R0.5HA	
6	6	100	15	50	1,2	8	2	1	7439666	EM-HSC01 H6.0x6/15/50 2R1.0HA	
6	6	100	15	50	1,2	8	2	1,5	7439667	EM-HSC01 H6.0x6/15/50 2R1.5HA	
6	6	100	15	50	1,2	8	2	2	7439668	EM-HSC01 H6.0x6/15/50 2R2.0HA	
8	8	120	20	60	1,2	10	2	0,5	7439669	EM-HSC01 H8.0x8/20/60 2R0.5HA	
8	8	120	20	60	1,2	10	2	1	7439670	EM-HSC01 H8.0x8/20/60 2R1.0HA	
8	8	120	20	60	1,2	10	2	2	7439671	EM-HSC01 H8.0x8/20/60 2R2.0HA	
10	10	150	30	100	0,9	12	2	0,5	7439672	EM-HSC01 H10.0x10/30/100 2R0.5HA	
10	10	150	30	100	0,9	12	2	1	7439673	EM-HSC01 H10.0x10/30/100 2R1.0HA	
10	10	150	30	100	0,9	12	2	2	7439674	EM-HSC01 H10.0x10/30/100 2R2.0HA	

Schnittwertempfehlungen ab Seite 80
Cutting data recommendations starting page 80

■ = Hauptanwendung First choice
□ = Nebenanwendung Second choice

HSC Toric-Finisher 30 H
Schafffräser, torisch
End mills, toric

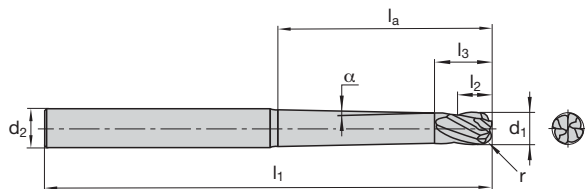

Katalog-Nr. Cat.-No.		HSC01-H-A									
P		<input type="checkbox"/>									
M											
K		<input type="checkbox"/>									
N											
S											
H		<input checked="" type="checkbox"/>									
d ₁					α			r	Ident No.	LMT-Code	
0 -0,015	l ₂	l ₁	l ₃	l _a	0 -0,2°	d ₂	z	±0,01			
lang long											
6	6	80	15	40	0,9	8	4	0,5	7439599	EM-HSC01 H6.0x6/15/40 4R0.5HA	
6	6	80	15	40	0,9	8	4	1	7439600	EM-HSC01 H6.0x6/15/40 4R1.0HA	
6	6	80	15	40	0,9	8	4	1,5	7439601	EM-HSC01 H6.0x6/15/40 4R1.5HA	
6	6	80	15	40	0,9	8	4	2	7439602	EM-HSC01 H6.0x6/15/40 4R2.0HA	
8	8	100	20	50	0,9	10	4	0,5	7439603	EM-HSC01 H8.0x8/20/50 4R0.5HA	
8	8	100	20	50	0,9	10	4	1	7439604	EM-HSC01 H8.0x8/20/50 4R1.0HA	
8	8	100	20	50	0,9	10	4	2	7439605	EM-HSC01 H8.0x8/20/50 4R2.0HA	
10	10	120	30	70	0,9	12	4	0,5	7439606	EM-HSC01 H10.0x10/30/70 4R0.5HA	
10	10	120	30	70	0,9	12	4	1	7439607	EM-HSC01 H10.0x10/30/70 4R1.0HA	
10	10	120	30	70	0,9	12	4	2	7439608	EM-HSC01 H10.0x10/30/70 4R2.0HA	
extra lang extra long											
6	6	100	15	50	1,2	8	4	0,5	7439609	EM-HSC01 H6.0x6/15/50 4R0.5HA	
6	6	100	15	50	1,2	8	4	1	7439610	EM-HSC01 H6.0x6/15/50 4R1.0HA	
6	6	100	15	50	1,2	8	4	1,5	7439611	EM-HSC01 H6.0x6/15/50 4R1.5HA	
6	6	100	15	50	1,2	8	4	2	7439612	EM-HSC01 H6.0x6/15/50 4R2.0HA	
8	8	120	20	60	1,2	10	4	0,5	7439613	EM-HSC01 H8.0x8/20/60 4R0.5HA	
8	8	120	20	60	1,2	10	4	1	7439614	EM-HSC01 H8.0x8/20/60 4R1.0HA	
8	8	120	20	60	1,2	10	4	2	7439615	EM-HSC01 H8.0x8/20/60 4R2.0HA	
10	10	150	30	100	0,9	12	4	0,5	7439616	EM-HSC01 H10.0x10/30/100 4R0.5HA	
10	10	150	30	100	0,9	12	4	1	7439617	EM-HSC01 H10.0x10/30/100 4R1.0HA	
10	10	150	30	100	0,9	12	4	2	7439618	EM-HSC01 H10.0x10/30/100 4R2.0HA	

Schnittwertempfehlungen ab Seite 80
Cutting data recommendations starting page 80

■ = Hauptanwendung First choice
□ = Nebenanwendung Second choice

HSC Toric-Finisher 30 H

Schnittwertempfehlungen für lange und extra lange, torische Schafffräser mit Eckenradius

Cutting data recommendations for long and extra long, toric end mills with corner radius

Werkstoff	Material	Werkstoff-Nr. Material No.	R _m /UTS (N/mm ²)	DIN Bezeichnung Alt DIN Description Old	Schnitt- geschwindigkeit Cutting speed v _c (m/min)	
P	Vergütbare Formenstähle	1.2311	950-1150	40CrMnMo7	230-280	
		1.2312	950-1150	40CrMnNiMoS8-6	260-300	
		1.2738	950-1150	45CrMnNiMo8-6-4	230-300	
		1.2711	950-1400	54NiCrMoV6	220-280	
		1.2358	850-1000	60CrMoV18-5	230-280	
	Durchhärtende Werkzeugstähle	Full hardening tools steels	1.2343	-950	X37CrMoV5 1	250-300
			1.2080	-850	X210Cr12	220-280
			1.2379	-850	X153CrVMo12 1	230-280
			1.2767	-900	X45NiCrMo4	250-300
	Nitrierstähle	Nitriding steels	1.8550	800-1000	34CrAlNi7	220-280
			1.8519	850-1050	31CrMoV9	240-320
			1.7735	850-1050	14CrMoV6.9	260-350
			1.2344	950-1100	X40CrMoV5-1	260-350
K	Grauguss	Grey cast iron	0.6025	400-900	EN-GJI-250	200-280
	Legierter Grauguss	Alloyed grey cast iron	0.6678	500-800	EN-GJLA-XNiCr35-2	220-280
	Sphäroguss	Nodular cast iron	0.7060	400-1000	EN-GJS-600-3	220-260
			0.7070		EN-GJS-700-2U	
Temperguss	Malleable cast iron	0.8155	500-1000	EN-GJMB-550-4	140-240	
H	Gehärteter Stahl		45-52 HRC		230-280	
			53-56 HRC		200-250	
			57-62 HRC		150-200	
			63-65 HRC		100-150	

Bei der langen Ausführung empfehlen wir die Vorschübe (f_z) um 30 % zu reduzieren.

When using the long version we recommend reducing the feed (f_z) by 30 %.

Die angegebenen Schnittwerte sind Startwerte und müssen auf die individuellen Einsatzbedingungen abgestimmt werden.

The cutting data specified are just for the first try. They need to be adjusted to the individual conditions within the production.

	Fräserdurchmesser Cutting diameter (mm)							Schlichten Finishing a _e (mm)
	Vorschub pro Zahn Feed per tooth f _z (mm/z.)							
	Ø 1	Ø 2	Ø 3	Ø 4	Ø 6	Ø 8	Ø 10	
	0,01	0,02	0,03	0,05	0,07	0,1	0,12–0,15	d x 0,018–0,02
	0,012	0,024	0,036	0,06	0,09	0,12	0,12–0,15	
	0,008	0,016	0,024	0,04	0,06	0,08	0,12–0,15	
	0,012	0,024	0,036	0,06	0,08	0,12	0,12–0,15	
	0,012	0,024	0,036	0,05	0,08	0,1	0,12–0,15	
	0,008	0,016	0,024	0,06	0,09	0,12	0,14	
	0,007	0,014	0,020	0,04	0,06	0,08	0,1	
	0,01	0,02	0,03	0,03	0,05	0,07	0,08	
	0,008	0,016	0,024	0,05	0,07	0,1	0,12	
	0,008	0,016	0,024	0,06	0,09	0,12	0,12–0,15	
	0,008	0,016	0,024	0,06	0,09	0,12	0,12–0,15	
	0,012	0,024	0,036	0,06	0,09	0,12	0,12–0,15	
	0,012	0,024	0,036	0,06	0,09	0,12	0,12–0,15	
	0,01	0,02	0,03	0,05	0,07	0,1	0,12–0,15	
	0,01	0,02	0,03	0,06	0,08	0,12	0,12–0,15	
	0,01	0,02	0,03	0,06	0,08	0,12	0,12–0,15	
	0,01	0,02	0,03	0,06	0,08	0,12	0,12–0,15	
	0,008	0,016	0,024	0,05	0,07	0,1	0,12–0,15	d x 0,018–0,02
	0,006	0,012	0,018	0,03	0,04	0,06	0,07	d x 0,01–0,018
	0,005	0,01	0,014	0,02	0,04	0,05	0,06	
	0,004	0,007	0,011	0,02	0,03	0,04	0,05	

HSC01 Finisher 30 H
Schafffräser mit Kantenschutzfase
 End mills with edge protection chamfer

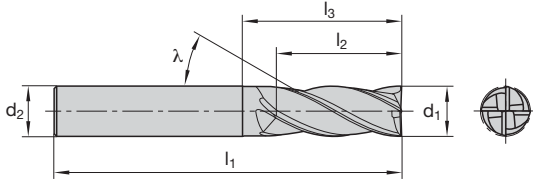

Katalog-Nr. Cat.-No.		HSC01-H-A					
P		<input type="checkbox"/>					
M							
K		<input type="checkbox"/>					
N							
S							
H		<input checked="" type="checkbox"/>					
d₁							
Ø 3-6	0 -0,038						
Ø 8-20	0 -0,047	l₂	l₁	l₃	d₂	z	Ident No.
lang long							
3	7,5	54	12	6	4	7440247	EM-HSC01 H3.0x7.5/12 4C0.05HA
4	10	54	12	6	4	7440248	EM-HSC01 H4.0x10/12 4C0.05HA
5	12,5	57	15	6	4	7440249	EM-HSC01 H5.0x12.5/15 4C0.05HA
6	15	57	21	6	4	7440250	EM-HSC01 H6.0x15/21 4C0.05HA
8	20	63	27	8	4	7440251	EM-HSC01 H8.0x20/27 4C0.05HA
10	25	72	32	10	4	7440252	EM-HSC01 H10.0x25/32 4C0.05HA
12	30	83	38	12	4	7440253	EM-HSC01 H12.0x30/38 4C0.1HA
16	40	100	52	16	4	7440254	EM-HSC01 H16.0x40/52 4C0.1HA
20	50	114	64	20	4	7440255	EM-HSC01 H20.0x50/64 4C0.1HA

■ = Hauptanwendung First choice
 □ = Nebenanwendung Second choice

Schnittwertempfehlungen ab Seite 84
 Cutting data recommendations starting page 84

Kantenschutzfase Edge protection chamfer	d ₁	b
	4-10	0,05
	12-20	0,1

HSC01 Finisher 30 H
Schafffräser mit Kantenschutzfase
 End mills with edge protection chamfer

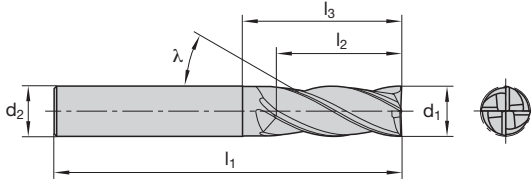

Katalog-Nr. Cat.-No.		HSC01-H-A					
P		<input type="checkbox"/>					
M							
K		<input type="checkbox"/>					
N							
S							
H		<input checked="" type="checkbox"/>					
d₁ 0 Ø 3-6 -0,038 0 Ø 8-20 -0,047	l₂	l₁	l₃	d₂	z	Ident No.	LMT-Code
extra lang extra long							
6	12	80	36	6	4	7440256	EM-HSC01 H6.0x12/36 4C0.05HA
8	16	90	48	8	4	7440257	EM-HSC01 H8.0x16/48 4C0.05HA
10	20	100	60	10	4	7440258	EM-HSC01 H10.0x20/60 4C0.05HA
12	24	120	72	12	4	7440259	EM-HSC01 H12.0x24/72 4C0.1HA
16	32	150	96	16	4	7440260	EM-HSC01 H16.0x32/96 4C0.1HA
20	40	175	120	20	4	7440261	EM-HSC01 H20.0x40/120 4C0.1HA

■ = Hauptanwendung First choice
 □ = Nebenanwendung Second choice

Schnittwertempfehlungen ab Seite 84
 Cutting data recommendations starting page 84

Kantenschutzfase Edge protection chamfer	d ₁	b
	4-10	0,05
	12-20	0,1

HSC01 Finisher 30 H

Schnittwertempfehlungen für Schafffräser mit Kantenschutzfase

Cutting data recommendations for end mills edge protection chamfer

Werkstoff		Material	Werkstoff-Nr. Material No.	DIN Bezeichnung Alt DIN Description Old	Härte Hardness	DIN Bezeichnung Neu DIN Description New
P	Vergütbare Formenstähle	Heat-treatable die steels	1.2311	40CrMnMo7	280–325 HB	40CrMnMo7
			1.2312	40CrMnMoS8.6	280–325 HB	40CrMnMoS8-6
			1.2738	40CrMnNiMoS8.6.4	280–325 HB	40CrMnNiMoS8-6-4
			1.2711	54NiCrMoV6	280–415 HB	54NiCrMoV6
	Durchhärtende Werkzeugstähle	Full hardening tools steels	1.2343	X38CrMoV5 1	230 HB	X37CrMoV5 1
			1.2080	X210Cr12	250 HB	X210Cr12
			1.2379	X155CrVMo12 1	250 HB	X153CrVMo12 1
			1.2767	X45NiCrMo4	260 HB	X45NiCrMo4
	Nitrierstähle	Nitriding steels	1.8550	34CrAlNi7	240–300 HB	34CrAlNi7
			1.8519	31CrMoV9	265–310 HB	31CrMoV9
1.7735			14CrMoV6.9	265–310 HB	14CrMoV6.9	
1.2344			X40CrMoV5.1	280–325 HB	X40CrMoV5-1	
K	Grauguss	Grey cast iron	0.6025	GG25	100–400 (120–260 HB)	EN-GJI-250
	Legierter Grauguss	Alloyed grey cast iron	0.6678	GGL-NiCr35 2	150–250 (160–230 HB)	EN-GJLA-XNiCr35-2
	Sphäroguss	Nodular cast iron	0.7060 0.7070	GGG60 GGG70L	400–800 (120–310 HB)	EN-GJS-600-3 EN-GJS-700-2U
	Temperguss	Malleable cast iron	0.8155	GTS55	350–700 (150–280 HB)	EN-GJMB-550-4
H	Gehärteter Stahl	Hardened steel			45–52 HRC	
					53–56 HRC	
					57–62 HRC	
					63–65 HRC	

Bei der langen Ausführung empfehlen wir die Vorschübe (f_z) um 30 % zu reduzieren.

When using the long version we recommend reducing the feed (f_z) by 30 %.

Die angegebenen Schnittwerte sind Startwerte und müssen auf die individuellen Einsatzbedingungen abgestimmt werden.

The cutting data specified are just for the first try. They need to be adjusted to the individual conditions within the production.

	Schnitt- geschwindigkeit Cutting speed v_c (m/min)	Fräserdurchmesser Cutting diameter (mm)								
		Vorschub pro Zahn Feed per tooth f_z (mm/z.)								
		3	4	5	6	8	10	12	16	20
	200–260	0,01	0,02	0,03	0,04	0,05	0,06	0,08	0,10	0,12
	220–280	0,012	0,02	0,04	0,05	0,06	0,07	0,10	0,12	0,14
	180–240	0,008	0,02	0,02	0,03	0,04	0,05	0,06	0,08	0,10
	200–260	0,012	0,02	0,04	0,05	0,06	0,07	0,10	0,12	0,14
	190–250	0,012	0,02	0,04	0,05	0,06	0,07	0,10	0,12	0,14
	160–220	0,008	0,02	0,02	0,03	0,04	0,05	0,06	0,08	0,10
	160–200	0,007	0,01	0,02	0,03	0,04	0,04	0,06	0,07	0,08
	200–260	0,01	0,02	0,03	0,04	0,05	0,06	0,08	0,10	0,12
	160–220	0,008	0,02	0,02	0,03	0,04	0,05	0,06	0,08	0,10
	180–240	0,008	0,02	0,02	0,03	0,04	0,05	0,06	0,08	0,10
	200–260	0,008	0,02	0,02	0,03	0,04	0,05	0,06	0,08	0,10
	200–260	0,012	0,02	0,04	0,05	0,06	0,07	0,10	0,12	0,14
	200–300	0,012	0,02	0,03	0,05	0,06	0,07	0,10	0,13	0,15
	180–280	0,01	0,02	0,03	0,04	0,06	0,07	0,09	0,12	0,13
	160–260	0,01	0,02	0,03	0,04	0,06	0,07	0,09	0,12	0,13
	140–240	0,01	0,02	0,03	0,04	0,06	0,07	0,09	0,12	0,13
	160–200	0,008	0,02	0,02	0,03	0,04	0,05	0,06	0,08	0,10
	120–150	0,006	0,01	0,02	0,02	0,03	0,04	0,05	0,06	0,07
	80–120	0,008	0,01	0,01	0,02	0,02	0,03	0,04	0,05	0,05
	60–100	0,006	0,01	0,01	0,01	0,02	0,02	0,03	0,04	0,04

HSC01 Ball-Nose-Finisher 30 H

Kopierfräser für allerhöchste Ansprüche

Copy milling cutter to fit highest requirements

Für die Entwicklung des VHM-Schaftfräasers mit 2 oder 4 Schneiden und runder Stirn wurde sowohl das Know-how der Werkzeugexperten von LMT Tools aufgegriffen. Das bereits bestehende Werkzeugprogramm wurde hierzu einer detaillierten Prüfung unterzogen. Bei der neuen Entwicklung wurden zahlreiche Verbesserungen umgesetzt.

Der HSC01 Ball-Nose-Finisher 30 H setzt Maßstäbe in Präzision sowie Prozesssicherheit und Standzeit. Darüber hinaus garantieren die angegebenen Schnittwerte ein Höchstmaß an Produktivität.

Der Erfolg lässt sich durch die bekannten Parameter Geometrie, Substrat und Beschichtung leicht beschreiben:

- Optimierte Geometrie mit sehr engen Fertigungstoleranzen für höchste Präzision im Einsatz
- Hochwertiges Substrat für hohe Schnittgeschwindigkeiten (Werkstoffe bis 65 HRC) und kürzere Bearbeitungszeiten
- Ausgereifte Beschichtung mit hoher Verschleißbeständigkeit für stabile Fertigungsprozesse

The know-how of the tool experts at LMT Tools was called upon to develop the solid carbide end mill with 2 or 4 cutting edges and a round face. In conjunction with this, the new existing tool range underwent a close check. Numerous improvements were implemented in the newly developed tool.

The HSC01 Ball-Nose-Finisher 30 H sets new standards with regard to precision, process reliability and service life. In addition, the specified cutting values ensure maximum productivity.

The success is easy to describe by means of the well-known parameters geometry, substrate and coating:

- Optimized geometry with very narrow manufacturing tolerances for maximum precision during use
- High quality substrate for high cutting speeds (materials up to 65 HRC) and shorter processing times
- Highly developed coating with high wear resistance for stable manufacturing processes

HSC01 Ball-Nose-Finisher 30 H

Eigenschaften auf einen Blick

Features at a glance

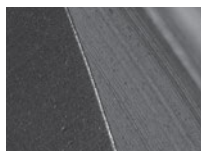

Definiert behandelte
Schneidkante
Defined preparation
of the cutting edge

Innovativer Schneidstoff (LCHK20M)
Innovative cutting material (LCHK20M)

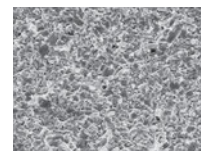

Ausgefällte Geometrie
der Stirn (S-Schliff)
Elaborate geometry
of the face (S-cut)



Sehr eng tolerierter Radius
 $\pm 0,005$ mm
Very closely tolerated radius
 ± 0.005 mm

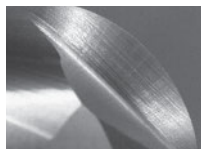

Leistungsstarke Mehrlagenbeschichtung
High-performance multi-layer coating

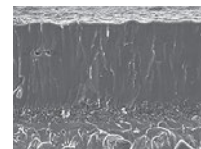

HSC01 Ball-Nose-Finisher 30 H
Kugel-Kopierfräser
Ball nose end mill

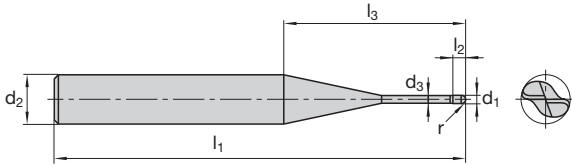

Katalog-Nr. Cat.-No.		HSC01-H-A							
P		<input type="checkbox"/>							
M		<input type="checkbox"/>							
K		<input type="checkbox"/>							
N		<input type="checkbox"/>							
S		<input type="checkbox"/>							
H		<input checked="" type="checkbox"/>							
d ₁ 0 -0,01	l ₂	l ₁	l ₃	d ₂	d ₃	z	r ±0,005	Ident No.	LMT-Code
kurz short									
1	1,5	50	3	4	0,94	2	0,5	7438541	EM-HSC01 H1.0x1.5/3 2BHA
1	1,5	50	3	6	0,94	2	0,5	7438542	EM-HSC01 H1.0x1.5/3 2BHA
1,5	2	50	4	4	1,4	2	0,75	7438543	EM-HSC01 H1.5x2/4 2BHA
1,5	2	50	4	6	1,4	2	0,75	7438544	EM-HSC01 H1.5x2/4 2BHA
2	3	50	6	4	1,85	2	1	7438545	EM-HSC01 H2.0x3/6 2BHA
2	3	50	6	6	1,85	2	1	7438546	EM-HSC01 H2.0x3/6 2BHA
2,5	3,5	60	8	6	2,35	2	1,25	7438547	EM-HSC01 H2.5x3.5/8 2BHA
3	4	60	9	6	2,85	2	1,5	7438548	EM-HSC01 H3.0x4/9 2BHA
lang long									
1	1,5	50	10	4	0,94	2	0,5	7438549	EM-HSC01 H1.0x1.5/10 2BHA
1	1,5	50	10	6	0,94	2	0,5	7438550	EM-HSC01 H1.0x1.5/10 2BHA
1,5	2	50	14	4	1,4	2	0,75	7438551	EM-HSC01 H1.5x2/14 2BHA
1,5	2	50	14	6	1,4	2	0,75	7438552	EM-HSC01 H1.5x2/14 2BHA
2	3	60	16	4	1,85	2	1	7438553	EM-HSC01 H2.0x3/16 2BHA
2	3	60	16	6	1,85	2	1	7438554	EM-HSC01 H2.0x3/16 2BHA
2,5	3,5	70	20	6	2,35	2	1,25	7438555	EM-HSC01 H2.5x3.5/20 2BHA
3	4	70	30	6	2,85	2	1,5	7438556	EM-HSC01 H3.0x4/30 2BHA
extra lang extra long									
1	1,5	60	16	4	0,94	2	0,5	7438557	EM-HSC01 H1.0x1.5/16 2BHA
1	1,5	70	16	6	0,94	2	0,5	7438558	EM-HSC01 H1.0x1.5/16 2BHA
1,5	2	60	20	4	1,4	2	0,75	7438559	EM-HSC01 H1.5x2/20 2BHA
1,5	2	70	20	6	1,4	2	0,75	7438560	EM-HSC01 H1.5x2/20 2BHA
2	3	70	30	4	1,85	2	1	7438561	EM-HSC01 H2.0x3/30 2BHA
2	3	80	30	6	1,85	2	1	7438562	EM-HSC01 H2.0x3/30 2BHA
2,5	3,5	80	30	6	2,35	2	1,25	7438563	EM-HSC01 H2.5x3.5/30 2BHA
3	4	80	35	6	2,85	2	1,5	7438564	EM-HSC01 H3.0x4/35 2BHA

Schnittwertempfehlungen ab Seite 90
 Cutting data recommendations starting page 90

■ = Hauptanwendung First choice
 □ = Nebenanwendung Second choice

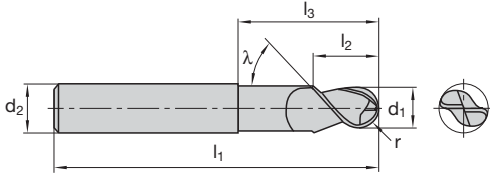

Katalog-Nr. Cat.-No.								HSC01-H-A	
P								<input type="checkbox"/>	
M									
K								<input type="checkbox"/>	
N									
S									
H								<input checked="" type="checkbox"/>	
d ₁ 0 -0,01	l ₂	l ₁	l ₃	d ₂	z	r ±0,005	Ident No.	LMT-Code	
kurz short									
4	5	57	14,5	6	2	2	7438565	EM-HSC01 H4.0x5/14.5 2BHA	
6	7,5	57	21	6	2	3	7438566	EM-HSC01 H6.0x7.5/21 2BHA	
8	10	63	27	8	2	4	7438567	EM-HSC01 H8.0x10/27 2BHA	
10	12,5	72	32	10	2	5	7438568	EM-HSC01 H10.0x12.5/32 2BHA	
12	15	83	38	12	2	6	7438569	EM-HSC01 H12.0x15/38 2BHA	
lang long									
4	5	80	19	6	2	2	7438570	EM-HSC01 H4.0x5/19 2BHA	
6	7,5	90	54	6	2	3	7438571	EM-HSC01 H6.0x7.5/54 2BHA	
8	10	100	64	8	2	4	7438572	EM-HSC01 H8.0x10/64 2BHA	
10	12,5	100	60	10	2	5	7438573	EM-HSC01 H10.0x12.5/60 2BHA	
12	15	110	65	12	2	6	7438574	EM-HSC01 H12.0x15/65 2BHA	

Schnittwertempfehlungen ab Seite 90
 Cutting data recommendations starting page 90

= Hauptanwendung First choice
 = Nebenanwendung Second choice

**Der S-Schliff im Zentrum der
 Stirnschneide ermöglicht optimale
 Schnittwerte und garantiert beste
 Oberflächengüten.**

**The S-cut in the center of the front
 cutting edge enables optimized
 cutting data to ensure high class
 surface qualities.**

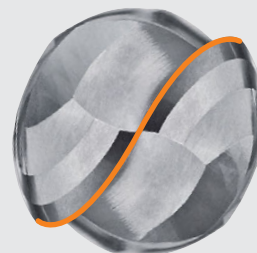

HSC01 Ball-Nose-Finisher 30 H
Kugel-Kopierfräser
 Ball nose end mill

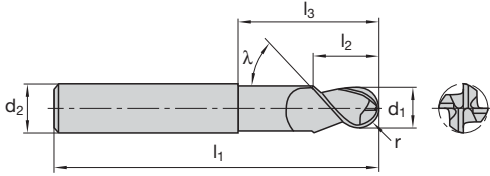

Katalog-Nr. Cat.-No.								HSC01-H-A	
P								<input type="checkbox"/>	
M									
K								<input type="checkbox"/>	
N									
S									
H								<input checked="" type="checkbox"/>	
d ₁ 0 -0,01	l ₂	l ₁	l ₃	d ₂	z	r ±0,005	Ident No.	LMT-Code	
kurz short									
4	5	57	14,5	6	4	2	7438855	EM-HSC01 H4.0x5/14.5 4BHA	
6	7,5	57	21	6	4	3	7438856	EM-HSC01 H6.0x7.5/21 4BHA	
8	10	63	27	8	4	4	7438857	EM-HSC01 H8.0x10/27 4BHA	
10	12,5	72	32	10	4	5	7438858	EM-HSC01 H10.0x12.5/32 4BHA	
12	15	83	38	12	4	6	7438859	EM-HSC01 H12.0x15/38 4BHA	
lang long									
4	5	80	19	6	4	2	7438860	EM-HSC01 H4.0x5/19 4BHA	
6	7,5	90	54	6	4	3	7438861	EM-HSC01 H6.0x7.5/54 4BHA	
8	10	100	64	8	4	4	7438862	EM-HSC01 H8.0x10/64 4BHA	
10	12,5	100	60	10	4	5	7438863	EM-HSC01 H10.0x12.5/60 4BHA	
12	15	110	65	12	4	6	7438864	EM-HSC01 H12.0x15/65 4BHA	

Schnittwertempfehlungen ab Seite 90
 Cutting data recommendations starting page 90

■ = Hauptanwendung First choice
 □ = Nebenanwendung Second choice

**Der S-Schliff im Zentrum der
 Stirnschneide ermöglicht optimale
 Schnittwerte und garantiert beste
 Oberflächengüten.**

The S-cut in the center of the front
 cutting edge enables optimized
 cutting data to ensure high class
 surface qualities.

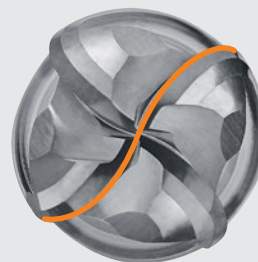

HSC01 Ball-Nose-Finisher 30 H

Schnittwertempfehlungen für Radiuskopierfräser

Cutting data recommendations for ball nose copy milling cutter

Werkstoff	Material	Werkstoff-Nr. Material No.	R _m /UTS (N/mm ²)	DIN Bezeichnung Alt DIN Description Old	Schnitt- geschwindigkeit Cutting speed v _c (m/min)	
P	Vergütbare Formenstähle	Heat-treatable die steels	1.2311	950-1150	40CrMnMo7	230-280
			1.2312	950-1150	40CrMnNiMoS8-6	260-300
			1.2738	950-1150	45CrMnNiMo8-6-4	230-300
			1.2711	950-1400	54NiCrMoV6	220-280
			1.2358	850-1000	60CrMoV18-5	230-280
	Durchhärtende Werkzeugstähle	Full hardening tools steels	1.2343	-950	X37CrMoV5 1	250-300
			1.2080	-850	X210Cr12	220-280
			1.2379	-850	X153CrVMo12 1	230-280
			1.2767	-900	X45NiCrMo4	250-300
	Nitrierstähle	Nitriding steels	1.8550	800-1000	34CrAlNi7	220-280
			1.8519	850-1050	31CrMoV9	240-320
			1.7735	850-1050	14CrMoV6.9	260-350
1.2344			950-1100	X40CrMoV5-1	260-350	
K	Grauguss	Grey cast iron	0.6025	400-900	EN-GJI-250	200-280
	Legierter Grauguss	Alloyed grey cast iron	0.6678	500-800	EN-GJLA-XNiCr35-2	220-280
	Sphäroguss	Nodular cast iron	0.7060 0.7070	400-1000	EN-GJS-600-3 EN-GJS-700-2U	220-260
	Temperguss	Malleable cast iron	0.8155	500-1000	EN-GJMB-550-4	140-240
H	Gehärteter Stahl	Werkzeugstähle und Sphärogusslegierungen, Kaltarbeitsstähle und PM-Stähle Tool steel and nodular cast iron alloys, cold working steel and powder metallurgical steel	45-52 HRC		230-280	
			53-56 HRC		200-250	
			57-62 HRC		150-200	
			63-65 HRC		100-150	

Bei der langen Ausführung empfehlen wir die Vorschübe (f_z) um 30 % zu reduzieren.

When using the long version we recommend reducing the feed (f_z) by 30 %.

Die angegebenen Schnittwerte sind Startwerte und müssen auf die individuellen Einsatzbedingungen abgestimmt werden.

The cutting data specified are just for the first try. They need to be adjusted to the individual conditions within the production.

	Fräserdurchmesser Cutting diameter (mm)								Schichten Finishing a_e (mm)
	Schichten Finishing a_p (mm) 0,02–0,12				Schichten Finishing a_p (mm) 0,08–0,2				
	Vorschub pro Zahn Feed per tooth f_z (mm/z.)								
	$\varnothing 1$	$\varnothing 2$	$\varnothing 3$	$\varnothing 4$	$\varnothing 6$	$\varnothing 8$	$\varnothing 10$	$\varnothing 12$	
	0,01	0,02	0,03	0,05	0,07–0,1	0,1	0,12–0,15	0,12–0,18	d x 0,018–0,02
	0,012	0,024	0,036	0,06	0,09–0,12	0,12	0,12–0,15	0,12–0,18	
	0,008	0,016	0,024	0,04	0,06–0,08	0,08	0,12–0,15	0,12–0,18	
	0,012	0,024	0,036	0,06	0,08–0,1	0,12	0,12–0,15	0,12–0,18	
	0,012	0,024	0,036	0,05	0,08–0,1	0,1	0,12–0,15	0,12–0,18	
	0,008	0,016	0,024	0,06	0,09	0,12	0,14	0,17	
	0,007	0,014	0,020	0,04	0,06	0,08	0,1	0,12	
	0,01	0,02	0,03	0,03	0,05	0,07	0,08	0,1	
	0,008	0,016	0,024	0,05	0,07	0,1	0,12	0,14	
	0,008	0,016	0,024	0,06	0,09–0,12	0,12	0,12–0,15	0,12–0,18	
	0,008	0,016	0,024	0,06	0,09–0,12	0,12	0,12–0,15	0,12–0,18	
	0,012	0,024	0,036	0,06	0,09–0,12	0,12	0,12–0,15	0,12–0,18	
	0,012	0,024	0,036	0,06	0,09–0,12	0,12	0,12–0,15	0,12–0,18	
	0,01	0,02	0,03	0,05	0,07–0,1	0,1	0,12–0,15	0,12–0,18	
	0,01	0,02	0,03	0,06	0,08–0,1	0,12	0,12–0,15	0,12–0,18	
	0,01	0,02	0,03	0,06	0,08–0,1	0,12	0,12–0,15	0,12–0,18	
	0,01	0,02	0,03	0,06	0,08–0,1	0,12	0,12–0,15	0,12–0,18	
	0,008	0,016	0,024	0,05	0,07–0,1	0,1	0,12–0,15	0,12–0,18	d x 0,018–0,02
	0,006	0,012	0,018	0,03	0,04	0,06	0,07	0,09	
	0,005	0,01	0,014	0,02	0,04	0,05	0,06	0,07	
	0,004	0,007	0,011	0,02	0,03	0,04	0,05	0,06	

Anwendungsbeispiel Application example



Gesenk- und Formenbau: Schichten Umformtechnik
Mold & Die: Finishing punching

Werkzeug Tool:

HSC01 Ball-Nose-Finisher 30 H
EM-HSC01 H12.0x15/65 2BHA (Ident No. 7438574)
 $d_1 = 12$ mm, $z = 2$

Schneidstoff Cutting material:

LCHK20M

Werkstoff Material:

1.2343, ca. 50–52 HRC

Schnittwerte Cutting data:

$v_c = 250$ m/min
 $n = 6635$ min⁻¹
 $f_z = 0,09$ mm
 $v_f = 1195$ mm/min
 $a_e = 0,1$ mm
 $a_p = 0,05$ mm

HSC01 Ball-Nose-Finisher 30 H
Kugel-Kopierfräser
Ball nose end mill

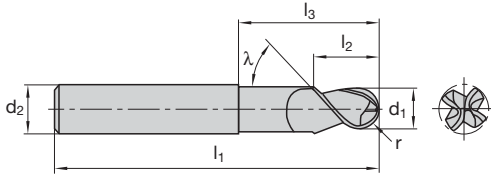

Katalog-Nr. Cat.-No.							HSC01-H-A	
P							<input type="checkbox"/>	
M								
K							<input type="checkbox"/>	
N								
S								
H							<input checked="" type="checkbox"/>	
d ₁	l ₂	l ₁	l ₃	d ₂	z	r Ø < 2,5 ±0,005 Ø 2,5-6 ±0,010 Ø > 6 ±0,015	Ident No.	LMT-Code
kurz short								
1	1	38	2,2	3	2	0,5	7441573	EM-HSC01 H1.0x1/2.2 2BHA
2	2	50	3,6	6	2	1	7441574	EM-HSC01 H2.0x2/3.6 2BHA
3	3	50	5,5	6	2	1,5	7441575	EM-HSC01 H3.0x3/5.5 2BHA
4	4	57	14,5	6	2	2	7441576	EM-HSC01 H4.0x4/14.5 2BHA
5	5	57	21	6	2	2,5	7441577	EM-HSC01 H5.0x5/21 2BHA
6	6	57	21	6	2	3	7441578	EM-HSC01 H6.0x6/21 2BHA
8	8	63	27	8	2	4	7441579	EM-HSC01 H8.0x8/27 2BHA
10	10	72	32	10	2	5	7441580	EM-HSC01 H10.0x10/32 2BHA
12	12	83	38	12	2	6	7441581	EM-HSC01 H12.0x12/38 2BHA
4	4	57	14,5	6	4	2	7441582	EM-HSC01 H4.0x4/14.5 4BHA
5	5	57	21	6	4	2,5	7441583	EM-HSC01 H5.0x5/21 4BHA
6	6	57	21	6	4	3	7441584	EM-HSC01 H6.0x6/21 4BHA
8	8	63	27	8	4	4	7441585	EM-HSC01 H8.0x8/27 4BHA
10	10	72	32	10	4	5	7441586	EM-HSC01 H10.0x10/32 4BHA
lang long								
4	4	80	19	6	2	2	7441587	EM-HSC01 H4.0x4/19 2BHA
5	5	80	44	6	2	2,5	7441588	EM-HSC01 H5.0x5/44 2BHA
6	6	80	44	6	2	3	7441589	EM-HSC01 H6.0x6/44 2BHA
8	8	90	54	8	2	4	7441590	EM-HSC01 H8.0x8/54 2BHA
10	10	100	60	10	2	5	7441591	EM-HSC01 H10.0x10/60 2BHA
12	12	110	65	12	2	6	7441592	EM-HSC01 H12.0x12/65 2BHA
4	4	80	19	6	4	2	7441593	EM-HSC01 H4.0x4/19 4BHA
5	5	80	44	6	4	2,5	7441594	EM-HSC01 H5.0x5/44 4BHA
6	6	80	44	6	4	3	7441595	EM-HSC01 H6.0x6/44 4BHA
8	8	90	54	8	4	4	7441596	EM-HSC01 H8.0x8/54 4BHA
10	10	100	60	10	4	5	7441597	EM-HSC01 H10.0x10/60 4BHA

Schnittwertempfehlungen ab Seite 94
 Cutting data recommendations starting page 94

■ = Hauptanwendung First choice
 = Nebenanwendung Second choice

HSC01 Ball-Nose-Finisher 30 H

Schnittwertempfehlungen für Schafffräser Typ H, gerade und runde Stirn

HSC01 Ball-Nose-Finisher 30 H

Cutting data recommendations for end mills type H, straight corner or ball nose

Werkstoff		Material	Werkstoff-Nr. Material No.	DIN Bezeichnung Alt DIN Description Old	Härte Hardness	DIN Bezeichnung Neu DIN Description New
P	Vergütbare Formenstähle	Heat-treatable die steels	1.2311	40CrMnMo7	280–325 HB	40CrMnMo7
			1.2312	40CrMnMoS8.6	280–325 HB	40CrMnMoS8-6
			1.2738	40CrMnNiMoS8.6.4	280–325 HB	40CrMnNiMoS8-6-4
			1.2711	54NiCrMoV6	280–415 HB	54NiCrMoV6
	Durchhärtende Werkzeugstähle	Full hardening tools steels	1.2343	X38CrMoV5 1	230 HB	X37CrMoV5 1
			1.2080	X210Cr12	250 HB	X210Cr12
			1.2379	X155CrVMo12 1	250 HB	X153CrVMo12 1
			1.2767	X45NiCrMo4	260 HB	X45NiCrMo4
	Nitrierstähle	Nitriding steels	1.8550	34CrAlNi7	240–300 HB	34CrAlNi7
			1.8519	31CrMoV9	265–310 HB	31CrMoV9
			1.7735	14CrMoV6.9	265–310 HB	14CrMoV6.9
			1.2344	X40CrMoV5.1	280–325 HB	X40CrMoV5-1
K	Grauguss	Grey cast iron	0.6025	GG25	100–400 (120–260 HB)	EN-GJI-250
	Legierter Grauguss	Alloyed grey cast iron	0.6678	GGL-NiCr35 2	150–250 (160–230 HB)	EN-GJLA-XNiCr35-2
	Sphäroguss	Nodular cast iron	0.7060	GGG60	400–800	EN-GJS-600-3
			0.7070	GGG70L	(120–310 HB)	EN-GJS-700-2U
Temperguss	Malleable cast iron	0.8155	GTS55	350–700 (150–280 HB)	EN-GJMB-550-4	
H	Gehärteter Stahl	Hardened steel			45–52 HRC	
					53–56 HRC	
					57–62 HRC	
					63–70 HRC	

Die angegebenen Schnittwerte sind Startwerte und müssen auf die vorhandenen Bedingungen abgestimmt werden.

The cutting data specified represents base values and must be adapted to the existing conditions.

Bei der langen Ausführung empfehlen wir die f_z -Werte um 30% zu reduzieren.

For high values of total feed we recommend reducing the specified unit values of feed (f_z) by 30%.

Hinweise zur Ermittlung des effektiven Schneidendurchmessers bei Kugelfräsern auf Seite 146.

Hints for calculation of the effective cutting diameter of ball nose end mills see page 146.

	Schnitt- geschwindigkeit Cutting speed v_c (m/min)	Fräserdurchmesser Cutting diameter (mm)								
		Vorschub pro Zahn Feed per tooth f_z (mm/z.)								
		1	2	3	4	5	6	8	10	12
	280-400	0,012	0,024	0,036	0,05	0,06	0,07	0,10	0,12	0,14
	280-400	0,014	0,03	0,043	0,06	0,07	0,09	0,12	0,14	0,17
	260-350	0,01	0,02	0,03	0,04	0,05	0,06	0,08	0,10	0,12
	260-350	0,014	0,03	0,043	0,06	0,07	0,09	0,12	0,14	0,17
	250-300	0,014	0,03	0,043	0,06	0,07	0,09	0,12	0,14	0,17
	220-280	0,01	0,02	0,03	0,04	0,05	0,06	0,08	0,10	0,12
	200-250	0,008	0,017	0,025	0,03	0,04	0,05	0,07	0,08	0,10
	250-300	0,01	0,024	0,036	0,05	0,06	0,07	0,10	0,12	0,14
	220-280	0,01	0,02	0,03	0,04	0,05	0,06	0,08	0,10	0,12
	240-320	0,01	0,02	0,03	0,04	0,05	0,06	0,08	0,10	0,12
	260-350	0,01	0,02	0,03	0,04	0,05	0,06	0,08	0,10	0,12
	260-350	0,014	0,03	0,043	0,06	0,07	0,09	0,12	0,14	0,17
	200-300	0,012	0,02	0,03	0,05	0,06	0,07	0,10	0,13	0,15
	180-280	0,01	0,018	0,025	0,04	0,06	0,07	0,09	0,12	0,13
	160-260	0,01	0,018	0,025	0,04	0,06	0,07	0,09	0,12	0,13
	140-240	0,01	0,018	0,025	0,04	0,06	0,07	0,09	0,12	0,13
	200-250	0,01	0,02	0,03	0,04	0,05	0,06	0,08	0,10	0,12
	180-220	0,007	0,014	0,02	0,03	0,04	0,04	0,06	0,07	0,09
	150-200	0,006	0,012	0,02	0,02	0,03	0,04	0,05	0,06	0,07
	100-150	0,005	0,01	0,01	0,02	0,02	0,03	0,04	0,05	0,06

HSC01 Finisher 20 P
Schafffräser mit Eckenradius
End mills with corner radius

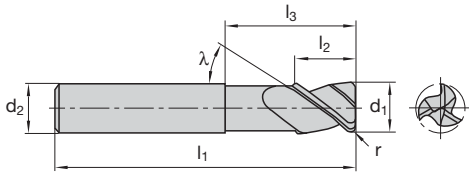

Katalog-Nr. Cat.-No.							HSC01-P-A		
P							<input checked="" type="checkbox"/>		
M							<input type="checkbox"/>		
K							<input checked="" type="checkbox"/>		
N							<input type="checkbox"/>		
S							<input type="checkbox"/>		
H							<input type="checkbox"/>		
O							<input type="checkbox"/>		
d ₁	l ₂	l ₁	l ₃	d ₂	z	r	Ident No.	LMT-Code	
kurz short									
1	1,5	38	2,7	3	2	0,2	7438980	EM-HSC01 P1.0x1.5/2.7 2R0.2HA	
2	2	50	3,6	6	2	0,3	7438981	EM-HSC01 P2.0x2/3.6 2R0.3HA	
3	3	50	5,5	6	2	0,4	7438982	EM-HSC01 P3.0x3/5.5 2R0.4HA	
4	4	57	14,5	6	2	0,5	7438983	EM-HSC01 P4.0x4/14.5 2R0.5HA	
4	4	57	14,5	6	2	1	7438984	EM-HSC01 P4.0x4/14.5 2R1.0HA	
5	5	57	21	6	2	0,6	7438986	EM-HSC01 P5.0x5/21 2R0.6HA	
6	6	57	21	6	2	0,3	7438988	EM-HSC01 P6.0x6/21 2R0.3HA	
6	6	57	21	6	2	0,5	7438989	EM-HSC01 P6.0x6/21 2R0.5HA	
6	6	57	21	6	2	0,8	7438990	EM-HSC01 P6.0x6/21 2R0.8HA	
6	6	57	21	6	2	1	7438991	EM-HSC01 P6.0x6/21 2R1.0HA	
8	8	63	27	8	3	0,3	7438992	EM-HSC01 P8.0x8/27 3R0.3HA	
8	8	63	27	8	3	1	7438993	EM-HSC01 P8.0x8/27 3R1.0HA	
8	8	63	27	8	3	2	7438995	EM-HSC01 P8.0x8/27 3R2.0HA	
10	10	72	32	10	3	0,5	7438996	EM-HSC01 P10.0x10/32 3R0.5HA	
10	10	72	32	10	3	1	7438997	EM-HSC01 P10.0x10/32 3R1.0HA	
10	10	72	32	10	3	1,25	7438998	EM-HSC01 P10.0x10/32 3R1.25HA	
10	10	72	32	10	3	2	7439000	EM-HSC01 P10.0x10/32 3R2.0HA	
12	12	83	38	12	3	1	7439002	EM-HSC01 P12.0x12/38 3R1.0HA	
12	12	83	38	12	3	1,6	7439004	EM-HSC01 P12.0x12/38 3R1.6HA	
12	12	83	38	12	3	2	7439005	EM-HSC01 P12.0x12/38 3R2.0HA	

Schnittwertempfehlungen ab Seite 100
 Cutting data recommendations starting page 100

= Hauptanwendung First choice
 = Nebenanwendung Second choice



HSC01 Finisher 20 P
Schafffräser mit Eckenradius
End mills with corner radius

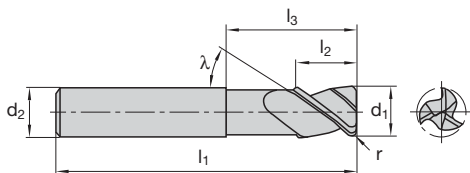

Katalog-Nr. Cat.-No.		HSC01-P-A						
P								
M								
K								
N								
S								
H								
O								
d ₁	l ₂	l ₁	l ₃	d ₂	z	r	Ident No.	LMT-Code
lang long								
2	2	70	17	6	2	0,3	7439009	EM-HSC01 P2.0x2/17 2R0.3HA
3	3	70	18	6	2	0,4	7439010	EM-HSC01 P3.0x3/18 2R0.4HA
5	5	80	44	6	2	0,6	7439014	EM-HSC01 P5.0x5/44 2R0.6HA
5	5	80	44	6	2	1	7439015	EM-HSC01 P5.0x5/44 2R1.0HA
6	6	80	44	6	2	0,3	7439016	EM-HSC01 P6.0x6/44 2R0.3HA
6	6	80	44	6	2	0,5	7439017	EM-HSC01 P6.0x6/44 2R0.5HA
6	6	80	44	6	2	0,8	7439018	EM-HSC01 P6.0x6/44 2R0.8HA
6	6	80	44	6	2	1	7439019	EM-HSC01 P6.0x6/44 2R1.0HA
8	8	90	54	8	3	0,3	7439020	EM-HSC01 P8.0x8/54 3R0.3HA
8	8	90	54	8	3	1	7439021	EM-HSC01 P8.0x8/54 3R1.0HA
8	8	90	54	8	3	1,5	7439022	EM-HSC01 P8.0x8/54 3R1.5HA
10	10	100	60	10	3	1	7439025	EM-HSC01 P10.0x10/60 3R1.0HA
10	10	100	60	10	3	1,25	7439026	EM-HSC01 P10.0x10/60 3R1.25HA
10	10	100	60	10	3	2	7439028	EM-HSC01 P10.0x10/60 3R2.0HA
12	12	110	65	12	3	1	7439030	EM-HSC01 P12.0x12/65 3R1.0HA
16	16	130	82	16	4	2	7439034	EM-HSC01 P16.0x16/82 4R2.0HA

Schnittwertempfehlungen ab Seite 100
 Cutting data recommendations starting page 100

■ = Hauptanwendung First choice
 □ = Nebenanwendung Second choice

HSC01 Ball-Nose-Finisher 20 P
Kugel-Kopierfräser
 Ball nose end mill

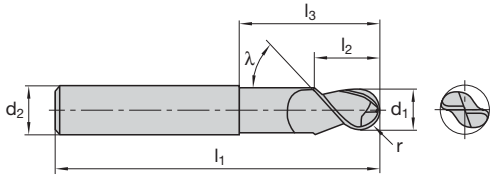

Katalog-Nr. Cat.-No.		HSC01-P-A							
P		■							
M		□							
K		■							
N		□							
S		□							
H		□							
d ₁	l ₂	l ₁	l ₃	d ₂	z	r	Ident No.	LMT-Code	
kurz short									
1	1,5	38	2,7	3	2	0,5	7438895	EM-HSC01 P1.0x1.5/2.7 2BHA	
2	2	50	3,6	6	2	1	7438896	EM-HSC01 P2.0x2/3.6 2BHA	
3	3	50	5,5	6	2	1,5	7438897	EM-HSC01 P3.0x3/5.5 2BHA	
4	4	57	14,5	6	2	2	7438898	EM-HSC01 P4.0x4/14.5 2BHA	
5	5	57	21	6	2	2,5	7438899	EM-HSC01 P5.0x5/21 2BHA	
6	6	57	21	6	2	3	7438900	EM-HSC01 P6.0x6/21 2BHA	
8	8	63	27	8	2	4	7438901	EM-HSC01 P8.0x8/27 2BHA	
10	10	72	32	10	2	5	7438902	EM-HSC01 P10.0x10/32 2BHA	
12	12	83	38	12	2	6	7438903	EM-HSC01 P12.0x12/38 2BHA	
16	16	92	44	16	4	8	7438904	EM-HSC01 P16.0x16/44 4BHA	
20	20	104	54	20	4	10	7438905	EM-HSC01 P20.0x20/54 4BHA	
lang long									
2	2	70	17	6	2	1	7438906	EM-HSC01 P2.0x2/17 2BHA	
3	3	70	18	6	2	1,5	7438907	EM-HSC01 P3.0x3/18 2BHA	
4	4	80	19	6	2	2	7438908	EM-HSC01 P4.0x4/19 2BHA	
5	5	80	44	6	2	2,5	7438909	EM-HSC01 P5.0x5/44 2BHA	
6	6	80	44	6	2	3	7438910	EM-HSC01 P6.0x6/44 2BHA	
8	8	90	54	8	2	4	7438911	EM-HSC01 P8.0x8/54 2BHA	
10	10	100	60	10	2	5	7438912	EM-HSC01 P10.0x10/60 2BHA	
12	12	110	65	12	2	6	7438913	EM-HSC01 P12.0x12/65 2BHA	
16	16	130	82	16	4	8	7438914	EM-HSC01 P16.0x16/82 4BHA	

Schnittwertempfehlungen ab Seite 100
 Cutting data recommendations starting page 100

■ = Hauptanwendung First choice
 □ = Nebenanwendung Second choice



HSC01 Ball-Nose-Finisher 20 P
Kugel-Kopierfräser
Ball nose end mill

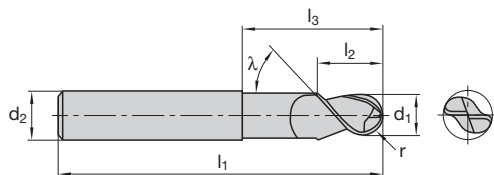

Katalog-Nr. Cat.-No.		HSC01-P-A						
P		<input checked="" type="checkbox"/>						
M		<input type="checkbox"/>						
K		<input checked="" type="checkbox"/>						
N		<input type="checkbox"/>						
S		<input type="checkbox"/>						
H		<input type="checkbox"/>						
d ₁	l ₂	l ₁	l ₃	d ₂	z	r	Ident No.	LMT-Code
extra lang extra long								
2	2	120	17	6	2	1	7438916	EM-HSC01 P2.0x2/17 2BHA
3	3	120	18	6	2	1,5	7438917	EM-HSC01 P3.0x3/18 2BHA
4	4	160	19	6	2	2	7438918	EM-HSC01 P4.0x4/19 2BHA
6	6	160	92	6	2	3	7438920	EM-HSC01 P6.0x6/92 2BHA
8	8	160	92	8	2	4	7438921	EM-HSC01 P8.0x8/92 2BHA
10	10	160	92	10	2	5	7438922	EM-HSC01 P10.0x10/92 2BHA
12	12	200	112	12	2	6	7438923	EM-HSC01 P12.0x12/112 2BHA
16	16	200	112	16	4	8	7438924	EM-HSC01 P16.0x16/112 4BHA

Schnittwertempfehlungen ab Seite 100
 Cutting data recommendations starting page 100

= Hauptanwendung First choice
 = Nebenanwendung Second choice

HSC01 Finisher 20 P & HSC01 Ball-Nose-Finisher 20 P
Schnittwertempfehlungen für Schafffräser mit Eckenradius und runder Stirn
Cutting data recommendations for end mills corner radius or ball nose

				DIN Bezeichnung Alt DIN	R _m /UTS (N/mm ²)	DIN Bezeichnung Neu DIN	
Werkstoff	Material	Werkstoff-Nr. Material No.		Description Old		Description New	
P	Unlegierter Baustahl + Automatenstahl	1.0570		St52-3	-700	S355J2G3	
		1.1730		C45	-800	C45U	
		1.0715		9SMn28	-700	11SMn30	
		1.1191		Ck45	500-950	C45E	
		1.7219		26CrMo4	500-950	26CrMo4-2	
	Vergütungsstahl, mittelfest	Heat-treatment steel, medium strength	1.7225		42CrMo4	500-950	42CrMo4
			1.8159		51CrV4		51CrV4
	Stahlguss	Cast steel	1.0416		GS40	-950	GS40
	Einsatzstahl	Case hardening steel	1.7131		16MnCr5	-950	16MnCr5
			1.4006		X10Cr13	500-950	X12Cr13
	Rost- und säurebe- ständiger Stahl, ferritisch, martensitisch	Stainless steel, ferritic, martensitic	1.4104		X12CrMoS17		X14CrMoS17
			1.4122		X35CrMo17		X39CrMo17-1
			1.7225		42CrMo4	950-1400	42CrMo4
	Vergütungsstahl, hochfest	Heat-treatment steel, high strength	1.6580		30CrNiMo8		30CrNiMo8
			1.8504		34CrAl6	950-1400	34CrAl6
	Nitrierstahl, vergütet	Nitriding steel, heat treated	1.2344		X40CrMoV5.1	-900	X40CrMoV5-1
			1.2343		X38CrMoV5 1	950-1400	X37CrMoV5-1
	Werkzeugstahl	Tool steel	1.2316		X38CrMo16	-1100	X38CrMo16
			1.2379		X155CrVMo12 1	-950	X153CrMoV12-1
1.2080				X210Cr12	950-1400	X210Cr12	
1.2358				60CrMoV18-5	850-1000	60CrMoV18-5	
1.2714				55NiCrMoV7	1100-1350	55NiCrMoV7	
1.2311				40CrMnMo7	-1100	40CrMnMo7	
1.2312				40CrMnNiMoS8.6	-1150	40CrMnNiMoS8-6	
1.2738				45CrMnNiMo8.6.4	950-1150	45CrMnNiMo8-6-4	
M	Rost- und säurebe- ständiger Stahl, austenitisch	1.4301		X2CrNiMo17-12-2	500-950	X5CrNiMo18-10	
		1.4404		X6CrNiMoTi17-12-2		X2CrNiMo17-12-2	
		1.4571		X10CrNiMoTi18	500-950	X10CrNiMoTi18	
	Rost- und säurebe- ständiger Stahl, martensitisch aushärtbar	Stainless steel, martensitic steel	1.2709		X3NiCoMoTi18-9-5	800-1000	X3NiCoMoTi18-9-5
			1.4542		X5CrNiCuNb16-4		X5CrNiCuNb16-4
1.4568		X7CrNiAl17-7		X7CrNiAl17-7			
K	Grauguss	0.6025		GG25	100-400 (120-260 HB)	EN-GJL-250	
					150-250 (160-230 HB)	EN-GJLA-XNiCr35-2	
	Legierter Grauguss	Alloyed grey cast iron	0.6678		GGL-NiCr35 2	400-800 (120-310 HB)	EN-GJS-700-2U
						EN-GJS-600-3	
Sphäroguss	Nodular cast iron	0.7070		GGG70L	350-700 (150-280 HB)	EN-GJMB-550-4	
					0.7060		GGG60
N	Aluminium-Legierungen, kurzspanend	3.2581		G-AlSi12	-400	G-IGK-AlSi12	
					Aluminium-Legierungen, langspanend	Aluminium alloys, long chipping	3.3535
	Kupfer-Legierungen, kurzspanend	Copper alloys, short chipping	2.0402		MS58	-500	CuZn40Pb2
						Kupfer-Legierungen, langspanend	Copper alloys, long chipping
	Thermoplaste	Thermoplastics	2.0975		PVC	300-500	CuAl10Fe5Ni5-C
						40-70	PVC
	Duroplaste	Duroplastics			Bakelit, Melamin	20-40	Bakelit, Melamin
Graphit						Graphite	
S	Titan-Legierungen, mittelfest	3.7115		TiAl5Sn2,5	-950	TiAl5Sn2-5	
					3.7164		TiAl6V4
	Titan-Legierungen, hochfest	Titanium alloys, high strength	3.7174		TiAl6Sn2	900-1400	TiAl6V6Sn2
						Nickelbasis-Legierungen, mittelfest	Nickel based alloys, medium strength
	Nickelbasis-Legierungen, hochwarmfest	Heat resistant nickel based alloys, high strength	2.4668		NiCr19Fe19NbMo	-950	NiCr12Al6MoNb
900-1400						Inconel 718 NiCr19Fe19Nb5Mo3	
H	Hartguss			Ni-hard, Ampco	300-600 HB	Ni-hard, Ampco	
					Gehärteter Stahl	Hardened steel	

Die angegebenen Schnittwerte sind Startwerte und müssen auf die vorhandenen Bedingungen abgestimmt werden.
The cutting data indicated are starting values based and must be adjusted to the prevailing conditions.

Hinweise zur Ermittlung des effektiven Schneidendurchmessers bei Kugelfräsern auf Seite 146.
Hints for calculation of the effective cutting diameter of ball nose end mills on page 146.

	Schnittgeschwindigkeit Cutting speed v_c (m/min)	Fräserdurchmesser Cutting diameter (mm)			
		Vorschub pro Zahn Feed per tooth f_z (mm/z.)			
		Schlichten Finishing			
	HSC01 20 P	Ø 1–4	Ø 5–8	Ø 10–12	Ø 14–20
	600	0,05	0,10	0,12	0,15
	600	0,05	0,10	0,12	0,15
	600	0,05	0,10	0,12	0,15
	450	0,04	0,07	0,10	0,13
	450	0,03	0,07	0,10	0,13
	400	0,015	0,04	0,08	0,12
	300	0,015	0,04	0,08	0,12
	350	0,03	0,06	0,09	0,13
	300	0,02	0,05	0,07	0,01
	250	0,03	0,06	0,90	0,12
	220				
	230	0,03	0,06	0,90	0,12
	250	0,04	0,07	0,10	0,13
	230	0,03	0,07	0,09	0,11
	180	0,04	0,07	0,10	0,13
	600	0,04	0,07	0,10	0,13
	500	0,04	0,07	0,10	0,14
	500	0,02	0,06	0,07	0,09
	350	0,02	0,06	0,07	0,09
	300	0,02	0,06	0,07	0,09
	800	0,04	0,08	0,10	0,12
	1000	0,04	0,08	0,10	0,12
	700	0,04	0,08	0,10	0,12
	1000	0,04	0,08	0,10	0,12
	600	0,05	0,10	0,12	0,15
	700	0,04	0,08	0,10	0,12
	1000	0,04	0,07	0,10	0,14
	120	0,02	0,06	0,07	0,09
	80	0,015	0,05	0,06	0,08
	100	0,02	0,06	0,07	0,09
	60	0,015	0,05	0,06	0,08
	50–70	0,025	0,05	0,06	0,08
	160–200	0,025	0,05	0,06	0,08

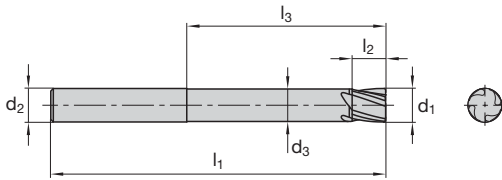

HSC 01 Toric-Finisher 20 H
Torischer Fräser 4-schneidig mit Halsfreistellung
Toric end mill 4 flute with neck relief



Katalog-Nr. Cat.-No.								HSC01-H-A		
P								■		
M										
K										
N										
S										
H								■		
d ₁	l ₂	l ₁	l ₃	d ₂	d ₃	z	r	Ident No.	LMT-Code	
kurz short										
4	4	45	11	6	3,8	4	0,5	7434494	EM-HSC01 H4.0x4/11 4R0.5HA	
4	4	45	11	6	3,8	4	1	7434495	EM-HSC01 H4.0x4/11 4R1HA	
5	5	50	12	6	4,8	4	0,5	7434496	EM-HSC01 H5.0x5/12 4R0.5HA	
5	5	50	12	6	4,8	4	1	7434497	EM-HSC01 H5.0x5/12 4R1HA	
6	3	50	12	6	7,8	4	0,5	7434500	EM-HSC01 H6.0x3/12 4R0.5HA	
8	4	60	21	8	7,8	4	1	7434504	EM-HSC01 H8.0x4/21 4R1HA	
8	4	60	21	8	7,8	4	2	7434505	EM-HSC01 H8.0x4/21 4R2HA	
10	5	70	27	10	9,8	4	0,5	7434510	EM-HSC01 H10.0x5/27 4R0.5HA	
10	5	70	27	10	9,8	4	2,5	7434511	EM-HSC01 H10.0x5/27 4R2.5HA	
12	6	75	27	12	11,7	4	3	7434512	EM-HSC01 H12.0x6/27 4R3HA	
lang long										
6	6	80	43	6	5,8	4	0,5	7434498	EM-HSC01 H6.0x6/43 4R0.5HA	
6	6	80	43	6	5,8	4	1	7434499	EM-HSC01 H6.0x6/43 4R1HA	
8	8	90	53	8	7,8	4	0,5	7434501	EM-HSC01 H8.0x8/53 4R0.5HA	
8	8	90	53	8	7,8	4	1	7434502	EM-HSC01 H8.0x8/53 4R1HA	
8	8	90	53	8	7,8	4	2	7434503	EM-HSC01 H8.0x8/53 4R2HA	
10	10	100	59	10	9,8	4	0,5	7434506	EM-HSC01 H10.0x10/59 4R0.5HA	
10	10	100	59	10	9,8	4	1	7434507	EM-HSC01 H10.0x10/59 4R1HA	
10	10	100	59	10	9,8	4	2	7434508	EM-HSC01 H10.0x10/59 4R2HA	
10	10	100	59	10	9,8	4	2,5	7434509	EM-HSC01 H10.0x10/59 4R2.5HA	
12	12	110	64	12	11,7	4	1	7434513	EM-HSC01 H12.0x12/64 4R1HA	
12	12	110	64	12	11,7	4	3	7434514	EM-HSC01 H12.0x12/64 4R3HA	

Schnittwertempfehlungen ab Seite 103
 Cutting data recommendations starting page 103

■ = Hauptanwendung First choice
 □ = Nebenanwendung Second choice

Werkstoff Material	Werkstoff-Nr. Material No.	R _m /UTS (N/mm ²)	DIN Bezeichnung DIN Description	Kühlung Coolant	Schnittgeschwindigkeit Cutting speed v _c (m/min)	Fräserdurchmesser Cutting diameter (mm)						Kantenfräsen Side milling		Nutenfräsen Slot milling
						Vorschub pro Zahn f _z Feed per tooth f _z (mm/z.)						a _p	a _e	a _p
						Ø 4	Ø 5	Ø 6	Ø 8	Ø 10	Ø 12			
P2 Stahl Steel	1.7225	500–1000	42CrMo4-NT Ck45		120–160	0,03	0,03	0,04	0,06	0,07	0,08	0,5 x D	0,4 x D	0,3 x D
	1.1191				90–150	0,02	0,03	0,04	0,05	0,06	0,07	0,5 x D	0,4 x D	0,3 x D
P3 Stahl Steel	1.2343	> 1000	X38CrMoV5 1 Toolox33											
H1 Hartguss u. gehärteter Stahl Chilled steel and Hardened steel		45–55 HRC	Ni-hard, Ampco		60–80	0,02	0,02	0,03	0,04	0,04	0,02	0,5 x D	0,3 x D	0,2 x D
H2 Gehärtete Stähle Hardened steel		56–60 HRC			50–70	0,01	0,02	0,02	0,03	0,04	0,04	0,5 x D	0,15 x D	0,15 x D
H3 Gehärtete Stähle Hardened steel		> 60 HRC			40–60	0,01	0,01	0,01	0,02	0,02	0,03	0,5 x D	0,1 x D	0,1 x D

f_z information is for side milling. For slot milling reduce f_z by 20 %.
 Lower value of cutting speed is used for high stock removal applications or for higher hardness (machinability) within group.
 Higher value of cutting speed is used for finishing applications or for lower hardness (machinability) within group.
 Above parameters are based on ideal conditions.

 **Trockenbearbeitung, Pressluftkühlung ist vorteilhaft**
 Dry machining, Compressed air cooling is advantageous

HSC 01 Ball-Nose-Finisher 15 H
Kugel-Kopierfräser mit konischem Hals
Ball nose end mill with conical neck

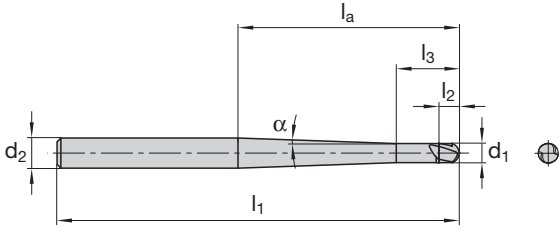

Katalog-Nr. Cat.-No.		HSC01-H-A									
P		■									
M											
K											
N											
S											
H		■									
d ₁	l ₂	l ₁	l ₃	l _a	α	d ₂	z	r	Ident No.		LMT-Code
lang long											
1	1	63	1	25	3,5	4	2	0,5	7434459		EM-HSC01 H1.0x1/1 2B0.5HA
2	2	63	2	19	3,5	4	2	1	7434460		EM-HSC01 H2.0x2/2 2B1.0HA
3	3	75	3	42	1,5	6	2	1,5	7434461		EM-HSC01 H3.0x3/3 2B1.5HA
4	4	75	4	42	1,5	6	2	2	7434462		EM-HSC01 H4.0x4/4 2B2.0HA

Schnittwertempfehlungen ab Seite 110
 Cutting data recommendations starting page 110

■ = Hauptanwendung First choice
 □ = Nebenanwendung Second choice

HSC 01 Ball-Nose-Finisher 20 H
Kugel-Kopierfräser mit Halsfreistellung
Ball nose end mill with neck relief

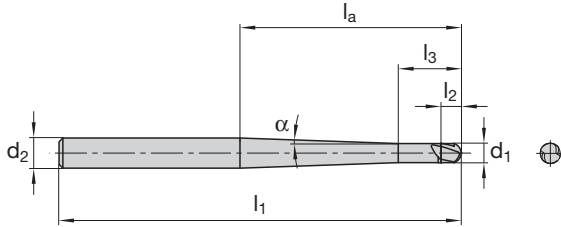

Katalog-Nr. Cat.-No.		HSC01-H-A									
P		■									
M											
K											
N											
S											
H		■									
d ₁	l ₂	l ₁	l ₃	l _a	α	d ₂	d ₃	z	r	Ident No.	LMT-Code
lang long											
2	2	70	18	34	1,5	6	1,9	2	1	7434464	EM-HSC01 H2.0x2/18 2B1HA
3	3	70	19	34	1,5	6	2,9	2	1,5	7434465	EM-HSC01 H3.0x3/19 2B1.5HA
4	4	80	18	44	1,5	6	3,8	2	2	7434466	EM-HSC01 H4.0x4/18 2B2HA
5	5	80	42	-	-	6	4,8	2	2,5	7434467	EM-HSC01 H5.0x5/42 2B2.5HA
6	6	80	43	-	-	6	5,8	2	3	7434468	EM-HSC01 H6.0x6/43 2B3HA
8	8	90	53	-	-	8	7,8	2	4	7434469	EM-HSC01 H8.0x8/53 2B4HA
10	10	100	60	-	-	10	9,7	2	5	7434470	EM-HSC01 H10.0x10/60 2B5HA
12	12	110	62	-	-	12	11,7	2	6	7434471	EM-HSC01 H12.0x12/62 2B6HA

Schnittwertempfehlungen ab Seite 110
 Cutting data recommendations starting page 110

■ = Hauptanwendung First choice
 □ = Nebenanwendung Second choice

HSC 01 Ball-Nose-Finisher 30 H
Kugel-Kopierfräser
Ball nose end mill

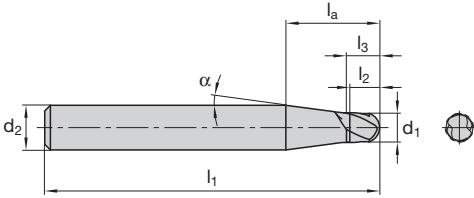

Katalog-Nr. Cat.-No.		HSC01-H-A									
P		■									
M											
K											
N											
S											
H		■									
d ₁	l ₂	l ₁	l ₃	l _a	α	d ₂	z	r	Ident No.		LMT-Code
lang long											
3	3	45	4	15	7,5	6	2	1,5	7434483	EM-HSC01 H3.0x3/4 2B1.5HA	
4	4	45	5	13	7,5	6	2	2	7434485	EM-HSC01 H4.0x4/5 2B2HA	
5	5	50	6	10	7,5	6	2	2,5	7434487	EM-HSC01 H5.0x5/6 2B2.5HA	
6	6	80	6	12	-	6	2	3	7434489	EM-HSC01 H6.0x6/6 2B3HA	
8	8	90	8	16	-	8	2	4	7434472	EM-HSC01 H8.0x8/8 2B4HA	
10	10	100	10	20	-	10	2	5	7434473	EM-HSC01 H10.0x10/10 2B5HA	
12	12	110	12	24	-	12	2	6	7434474	EM-HSC01 H12.0x12/12 2B6HA	

Schnittwertempfehlungen ab Seite 110
 Cutting data recommendations starting page 110

■ = Hauptanwendung First choice
 □ = Nebenanwendung Second choice

HSC 01 Ball-Nose-Finisher 30 H

Kugel-Kopierfräser 4-schneidig mit konischem Hals und verstärktem Schaft

Ball nose end mill 4 flute with conical neck and reinforced shank

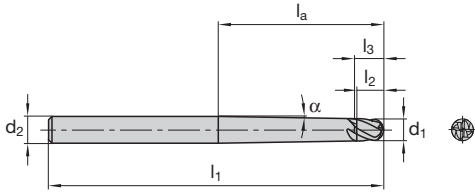

Katalog-Nr. Cat.-No.		HSC01-H-A									
P		■									
M											
K											
N											
S											
H		■									
d ₁	l ₂	l ₁	l ₃	l _a	α	d ₂	z	r	Ident No.	LMT-Code	
lang long											
3	4	75	4,5	37	2,64	6	4	1,5	7434475	EM-HSC01 H3.0x4/4.5 4B1.5HA	
4	5	75	5,5	37	1,82	6	4	2	7434476	EM-HSC01 H4.0x5/5.5 4B2HA	
5	6	75	6,5	37	0,94	6	4	2,5	7434477	EM-HSC01 H5.0x6/6.5 4B2.5HA	
6	8	75	8,5	37	2	8	4	3	7434478	EM-HSC01 H6.0x8/8.5 4B3HA	
extra lang extra long											
8	12	150	12,5	103	1,27	12	4	4	7434479	EM-HSC01 H8.0x12/12.5 4B4HA	
10	15	150	15,5	103	0,65	12	4	5	7434480	EM-HSC01 H10.0x15/15.5 4B5HA	

Schnittwertempfehlungen ab Seite 110
Cutting data recommendations starting page 110

■ = Hauptanwendung First choice
□ = Nebenanwendung Second choice

HSC 01 Ball-Nose-Finisher 30 H
Kugel-Kopierfräser mit 240° Schneide
 Ball nose end mill with 240° cutting edge

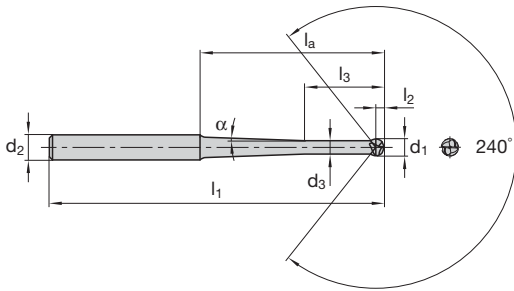



Katalog-Nr. Cat.-No.		HSC01-H-A									
P		■									
M											
K											
N											
S											
H		■									
d ₁	l ₂	l ₁	l ₃	l _a	α	d ₂	d ₃	z	r	Ident No.	LMT-Code
lang long											
2	1	70	17	34	6	6	1,6	2	1	7434481	EM-HSC01 H2.0x1/17 2B1HA
3	1,5	70	18	34	5	6	2,4	2	1,5	7434482	EM-HSC01 H3.0x1.5/18 2B1.5HA
4	2	80	19	44	2	6	3,2	2	2	7434484	EM-HSC01 H4.0x2/19 2B2HA
5	2,5	80	42	44	-	6	4,1	2	2,5	7434486	EM-HSC01 H5.0x2.5/42 2B2.5HA
6	3	80	42	44	-	6	4,9	2	3	7434488	EM-HSC01 H6.0x3/42 2B3HA
8	4	90	52	54	-	8	6,5	2	4	7434490	EM-HSC01 H8.0x4/52 2B4HA
10	5	100	58	60	-	10	8,2	2	5	7434492	EM-HSC01 H10.0x5/58 2B5HA
12	6	110	63	65	-	12	9,9	2	6	7434493	EM-HSC01 H12.0x6/63 2B6HA

Schnittwertempfehlungen ab Seite 110
 Cutting data recommendations starting page 110

■ = Hauptanwendung First choice
 □ = Nebenanwendung Second choice

HSC 01 Ball-Nose-Finisher 15 H, 20 H & 30 H
Schnittwertempfehlungen
Cutting data recommendations

Werkstoff Material		Werkstoff-Nr. Material No.	R _m /UTS (N/mm ²)	DIN Bezeichnung DIN Description	Kühlung Coolant	Schnittgeschwindigkeit Cutting speed v _c (m/min)
P2	Stahl Steel	1.7225	500-1000	42CrMo4-NT Ck45		210-230
		1.1191				270-310
						420-470
P3	Stahl Steel	1.2343	> 1000	X38CrMoV5 1 Toolox33		180-210
						240-270
						370-420
H1	Hartguss und gehärteter Stahl Chilled steel and Hardened steel		45-55 HRC	Ni-hard, Ampco		120-200
					160-280	
					200-350	
H2	Gehärtete Stähle Hardened steel		56-60 HRC			140-210
				180-260		
				220-320		
H3	Gehärtete Stähle Hardened steel		> 60 HRC			120-160
				150-200		
				180-250		

Die angegebenen Schnittwerte sind Startwerte und müssen auf die vorhandenen Bedingungen abgestimmt werden.
 The specified cutting data are start values and must be adjusted to the existing conditions.



Trockenbearbeitung, Pressluftkühlung ist vorteilhaft
 Dry machining, Compressed air cooling is advantageous

	Fräserdurchmesser Cutting diameter (mm)								Schruppen Roughing		Vorschlichten Semi finishing		Schlichten Finishing	
	Vorschub pro Zahn f_z Feed per tooth f_z (mm/z.)													
	Ø 2	Ø 3	Ø 4	Ø 5	Ø 6	Ø 8	Ø 10	Ø 12	a_p	a_e	a_p	a_e	a_p	a_e
	0,015	0,023	0,03	0,04	0,05	0,07	0,08	0,09	0,2 x D	0,1 x D				
	0,034	0,052	0,07	0,09	0,11	0,15	0,18	0,21			0,1 x D	0,05 x D		
	0,052	0,080	0,11	0,14	0,17	0,23	0,28	0,32					0,04 x D	0,04 x D
	0,014	0,021	0,03	0,04	0,04	0,06	0,07	0,08	0,2 x D	0,1 x D				
	0,031	0,048	0,06	0,08	0,10	0,13	0,16	0,19			0,1 x D	0,05 x D		
	0,048	0,073	0,10	0,13	0,15	0,21	0,25	0,29					0,04 x D	0,04 x D
	0,024	0,036	0,05	0,06	0,07	0,10	0,12	0,14	0,1 x D	0,075 x D				
	0,034	0,052	0,07	0,88	0,11	0,15	0,17	0,20			0,05 x D	0,04 x D		
	0,039	0,059	0,08	0,10	0,12	0,17	0,20	0,23					0,03 x D	0,03 x D
	0,027	0,041	0,06	0,07	0,08	0,11	0,14	0,16	0,05 x D	0,05 x D				
	0,031	0,047	0,06	0,08	0,10	0,13	0,16	0,18			0,03 x D	0,03 x D		
	0,033	0,050	0,07	0,08	0,10	0,14	0,17	0,20					0,02 x D	0,02 x D
	0,018	0,027	0,04	0,05	0,06	0,08	0,09	0,11	0,05 x D	0,05 x D				
	0,021	0,031	0,04	0,05	0,06	0,09	0,11	0,12			0,03 x D	0,03 x D		
	0,022	0,033	0,05	0,06	0,07	0,09	0,11	0,13					0,02 x D	0,02 x D

Qualität, Produktivität, Zuverlässigkeit

Herkömmliches Kopierfräsen

Kugel-Kopierfräser, die im allgemeinen zum Kopierfräsen eingesetzt werden, benutzen ungefähr die Hälfte der Werkzeugschneide während der Bearbeitung. Um eine glatte Oberfläche mit entsprechender Qualität zu erzeugen, sind daher mehrere Werkzeugbahnen mit kleinen Sprüngen erforderlich, was zu einer längeren Bearbeitungszeit führt.

Kugel-Kopierfräser sind während der Bearbeitung in ständigem Kontakt mit dem Werkstück und dem Material, was zu erhöhten Axialkräften und potentiell zu erhöhter Vibration führt. Stärkere Vibrationen verringern die Werkzeugstandzeit und gleichzeitig die Oberflächenqualität.

Aufgrund dieser Aspekte hat LMT Onsrud die Kreissegment- oder Radialfräser entwickelt.

Kreissegment- oder Radialfräsen

Radialfräser wurden für den Einsatz in einer 5-Achsen-Bearbeitungsumgebung entwickelt und ermöglichen einen optimierten Werkzeugeingriff bei dem zu bearbeitenden Werkstück. Diese Optimierung ermöglicht eine höhere Produktivität durch höhere Materialabtragsraten pro Durchlauf bei gleichzeitiger Reduzierung der Bearbeitungszeit.

Zusätzlich zu der geringeren Zahl an Werkzeugbahnen werden Materialschwingungen oder „Rattern“ verringert, wodurch eine sehr gute Werkstückoberfläche erzeugt wird. Außerdem werden weniger Kräfte auf das Werkzeug selbst ausgeübt, was zu einer höheren Werkzeugstandzeit führt.

Quality, Productivity, Reliability

Conventional Ball nose Milling

Generally utilized for contour milling, ball nose tools use approximately half of the tool's cutting edge during machining. This, therefore, requires multiple machining passes to create a smooth sidewall or surface finish leading to longer production timeframes.

During machining, ball nose end mills remain in constant contact with the material being cut leading to increased axial forces on the tool and, potentially, increased vibration within the machined part itself. Higher vibration tends to reduce tool life, while diminishing the part finish within a 3-axis work pattern.

It is because of these aspects of machining that LMT Onsrud has developed a line of Radial Milling Cutters.

Radial Milling

Created to be used within a 5-axis machining environment, Radial Milling Cutters have been designed to allow for increased tool engagement with the material being cut. This increase allows for greater productivity through higher material removal rates per pass, while reducing machining time.

In addition to fewer machining passes required, material vibration or "chatter" is also lessened creating a superior work piece finish. Less stress is also being placed onto the tool itself resulting in greater tool life.

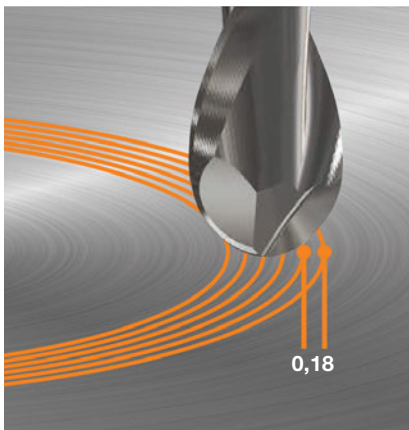

Kugel-Kopierfräser haben einen kleineren Eingriffsbereich und dadurch einen geringeren Zeilensprung
Ball nose tools have a narrow engagement area resulting in a smaller step over length

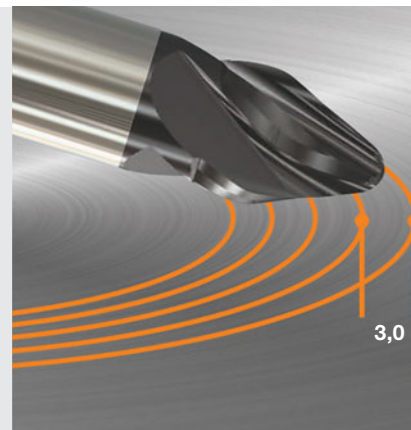

Kreissegmentfräser erlauben einen höheren Werkzeugeingriff und somit größere Zeilensprünge
Radial milling cutter allow for greater tool engagement an increased step over lengths

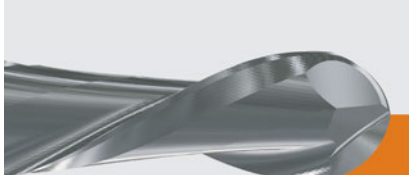

Anteil der Werkzeugschneide im Eingriff zum Material
Portion of tool engaged with material



Anteil der Werkzeugschneide im Eingriff zum Material
Portion of tool engaged with material

RMC-B01 Finisher 30 UNI
Radialfräser mit Tonnenprofil
Radial milling cutter with barrel shape

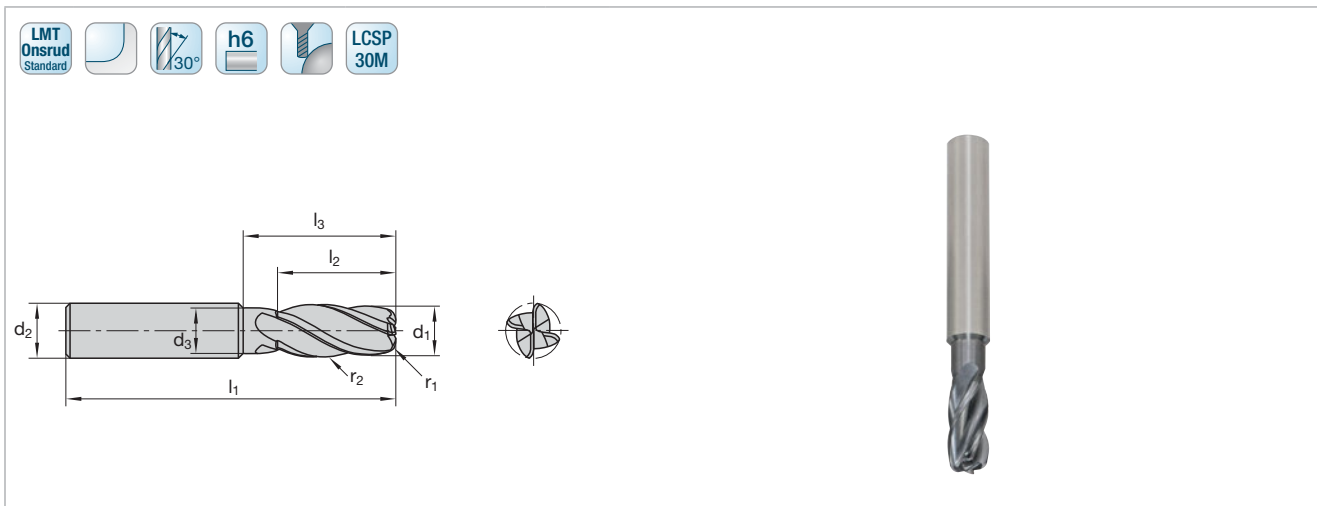

Katalog-Nr. Cat.-No.										RMC-B01-U-A	
P										■	
M										■	
K										■	
N										■	
S										■	
H										□	
d ₁	l ₂	l ₁	l ₃	d ₃	d ₂	z	r ₁	r ₂	Ident No.	LMT-Code	
lang long											
10	21	73	30	8	10	4	1	60	2647642	EM-RMC01 U10.0x21/30 4R1/60HA	

Schnittwertempfehlungen ab Seite 118
 Cutting data recommendations starting page 118

■ = Hauptanwendung First choice
 □ = Nebenanwendung Second choice

RMC-L01 Finisher 35/36 UNI
Radialfräser mit Linsenprofil
 Radial milling cutter with lens shape

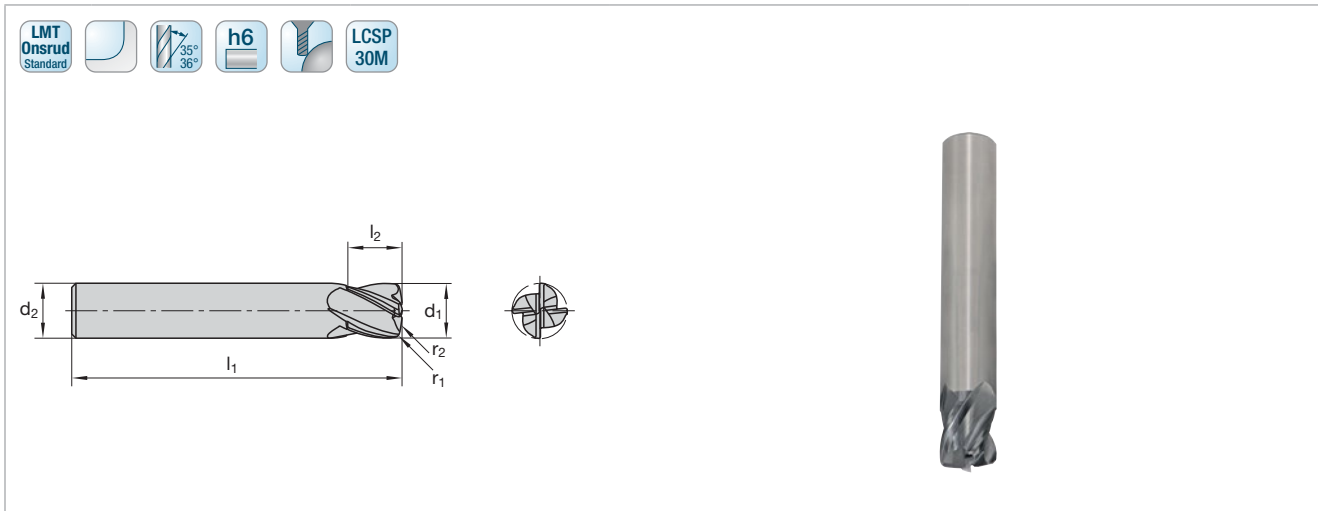

Katalog-Nr. Cat.-No.							RMC-L01-U-A		
P									■
M									■
K									■
N									■
S									■
H									□
d ₁	l ₂	l ₁	d ₂	z	r ₁	r ₂	Ident No.		LMT-Code
lang long									
16	16	100	16	4	2	30	2648217		EM-RMC01 U16.0x16 4R2/30HA

Schnittwertempfehlungen ab Seite 118
 Cutting data recommendations starting page 118

■ = Hauptanwendung First choice
 □ = Nebenanwendung Second choice

RMC-CTA01 Finisher 30 UNI
Radialfräser mit konischem Profil Form A
Radial milling cutter with conical taper shape A

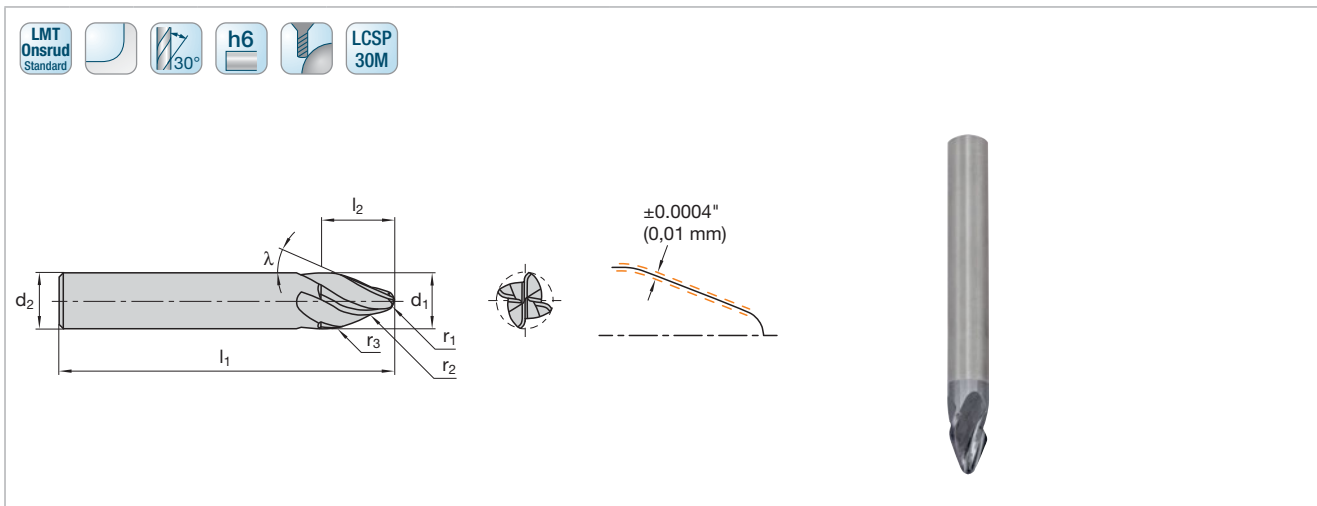

Katalog-Nr. Cat.-No.	RMC-CTA01-U-A
P	<input checked="" type="checkbox"/>
M	<input checked="" type="checkbox"/>
K	<input checked="" type="checkbox"/>
N	<input checked="" type="checkbox"/>
S	<input checked="" type="checkbox"/>
H	<input type="checkbox"/>

d₁	l₂	l₁	d₂	z	r₁	r₂	r₃	Anstell- winkel Tilt Angle	Ident No.	LMT-Code
lang long										
6	9,5	64	6	4	1	250	3	17,5°	2647647	EM-RMC01 U6.0x9.5 4R1/250HA
10	12,5	80	10	4	2	250	5	20°	2647648	EM-RMC01 U10.0x12.5 4R2/250HA
12	22	88	12	4	3	250	6	20°	2647649	EM-RMC01 U12.0x22 4R3/250HA
16	24	109	16	4	4	1000	8	12,5°	2647646	EM-RMC01 U16.0x24 4R4/100HA

Schnittwertempfehlungen ab Seite 118
 Cutting data recommendations starting page 118

= Hauptanwendung First choice
 = Nebenanwendung Second choice

RMC-CTB01 Finisher 40 UNI
Radialfräser mit konischem Profil Form B
Radial milling cutter with conical taper shape B

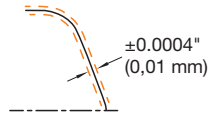
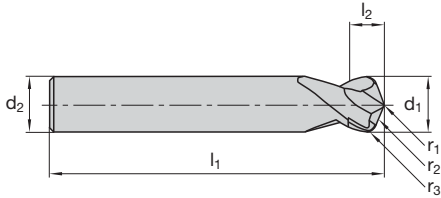

Katalog-Nr. Cat.-No.									RMC-CTB01-U-A	
P										■
M										■
K										■
N										■
S										■
H										<input type="checkbox"/>
d ₁	l ₂	l ₁	d ₂	z	r ₁	r ₂	r ₃	Anstell- winkel Tilt Angle	Ident No.	LMT-Code
lang long										
10	6	81	10	2	1	200	2	70°	2648216	EN-RMC01 U10.0x6 2R1/200/2HA

Schnittwertempfehlungen ab Seite 118
 Cutting data recommendations starting page 118

■ = Hauptanwendung First choice
 = Nebenanwendung Second choice

RMC-O01 Finisher 30 UNI
Radialfräser mit Tropfenprofil
Radial milling cutter with oval shape

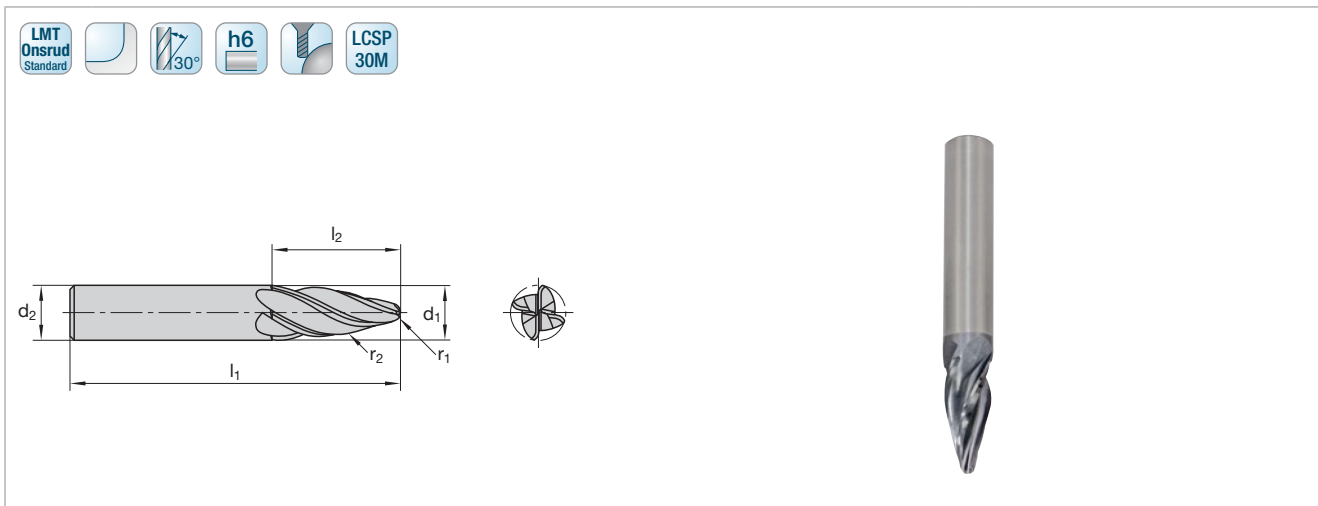

Katalog-Nr. Cat.-No.							RMC-O01-U-A		
P									■
M									■
K									■
N									■
S									■
H									□
d ₁	l ₂	l ₁	d ₂	z	r ₁	r ₂	Ident No.	LMT-Code	
lang long									
6	22	64	6	4	1	95	2647643	EM-RMC01 U6.0x22 4R1/95HA	
10	24,5	73	10	4	2	90	2647644	EM-RMC01 U10.0x24.5 4R2/90HA	
12	27	84	12	4	2	85	2647645	EM-RMC01 U12.0x27 4R2/85HA	

Schnittwertempfehlungen ab Seite 118
 Cutting data recommendations starting page 118

■ = Hauptanwendung First choice
 □ = Nebenanwendung Second choice

Werkstoff		Material	Werkstoff-Nr. Material No.	DIN Bezeichnung Alt DIN Description Old	R _m /UTS (N/mm ²)	DIN Bezeichnung Neu DIN Description New
P	Unlegierter Baustahl + Automatenstahl	Plain carbon steel + free cutting steel	1.0570	St52-3	-700	S355J2G3
			1.1730	C45	-800	C45U
			1.0715	9SMn28	-700	11SMn30
			1.1191	Ck45	500-950	C45E
			1.7219	26CrMo4		26CrMo4-2
	Vergütungsstahl, mittelfest	Heat-treatment steel, medium strength	1.7225	42CrMo4	500-950	42CrMo4
			1.8159	51CrV4		51CrV4
	Stahlguss	Cast steel	1.0416	GS40	-950	GS40
	Einsatzstahl	Case hardening steel	1.7131	16MnCr5	-950	16MnCr5
	Rost- und säure- beständiger Stahl, ferritisch, martensitisch	Stainless steel, ferritic, martensitic	1.4006	X10Cr13	500-950	X12Cr13
			1.4104	X12CrMoS17		X14CrMoS17
			1.4122	X35CrMo17		X39CrMo17-1
	Vergütungsstahl, hochfest	Heat-treatment steel, high strength	1.7225	42CrMo4	950-1400	42CrMo4
			1.6580	30CrNiMo8		30CrNiMo8
	Nitrierstahl, vergütet	Nitriding steel, heat treated	1.8504	34CrAl6	950-1400	34CrAl6
		1.2344	X40CrMoV5.1	-900	X40CrMoV5-1	
Werkzeugstahl	Tool steel	1.2343	X38CrMoV5 1	950-1400	X37CrMoV5-1	
		1.2316	X38CrMo16	-1100	X38CrMo16	
		1.2379	X155CrVMo12 1	-950	X153CrMoV12-1	
		1.2080	X210Cr12	950-1400	X210Cr12	
		1.2358	60CrMoV18-5	850-1000	60CrMoV18-5	
		1.2714	55NiCrMoV7	1100-1350	55NiCrMoV7	
		1.2311	40CrMnMo7	-1100	40CrMnMo7	
		1.2312	40CrMnNiMoS8.6	-1150	40CrMnNiMoS8-6	
		1.2738	45CrMnNiMo8.6.4	950-1150	45CrMnNiMo8-6-4	
M	Rost- und säurebe- ständiger Stahl, austenitisch	Stainless steel, austenitic	1.4301	X2CrNiMo17-12-2	500-950	X5CrNiMo18-10
			1.4404	X6CrNiMoTi17-12-2		X2CrNiMo17-12-2
			1.4571	X10CrNiMoTi18	500-950	X10CrNiMoTi18
	Rost- und säure- beständiger Stahl, martensitisch aushärtbar	Stainless steel, martensitic steel	1.2709	X3NiCoMoTi18-9-5	800-1000	X3NiCoMoTi18-9-5
			1.4542	X5CrNiCuNb16-4		X5CrNiCuNb16-4
		1.4568	X7CrNiAl17-7		X7CrNiAl17-7	
K	Grauguss	Grey cast iron	0.6025	GG25	100-400 (120-260 HB)	EN-GJL-250
	Legierter Grauguss	Alloyed grey cast iron	0.6678	GGL-NiCr35 2	150-250 (160-230 HB)	EN-GJLA-XNiCr35-2
	Sphäroguss	Nodular cast iron	0.7070	GGG70L	400-800	EN-GJS-700-2U
			0.7060	GGG60	(120-310 HB)	EN-GJS-600-3
Temperguss	Malleable cast iron	0.8155	GTS55	350-700 (150-280 HB)	EN-GJMB-550-4	
N	Aluminium-Legierungen, kurzspanend	Aluminium alloys, short chipping	3.2581	G-AlSi12	-400	G-IGK-AlSi12
	Aluminium-Legierungen, langspanend	Aluminium alloys, long chipping	3.3535	AlMg3	-550	AlMg3
			3.4365	AlZnMgCu1,5		AlZnMgCu1,5
	Kupfer-Legierungen, kurzspanend	Copper alloys, short chipping	2.0402	MS58	-500	CuZn40Pb2
	Kupfer-Legierungen, langspanend	Copper alloys, long chipping	2.0320	MS63	300-500	CuZn37
		2.0975	CuAl10Ni		CuAl10Fe5Ni5-C	
S	Titan-Legierungen, mittelfest	Titanium alloys, medium strength	3.7115	TiAl5Sn2,5	-950	TiAl5Sn2-5
			3.7164	TiAl6V4		Ti6AlV4
	Titan-Legierungen, hochfest	Titanium alloys, high strength	3.7174	TiAl6Sn2	900-1400	TiAl6V6Sn2
	Nickelbasis-Legierungen, mittelfest	Nickel based alloys, medium strength	2.4670	NiCr12Al6MoNb	-950	NiCr12Al6MoNb
Nickelbasis-Legierungen, hochwarmfest	Heat resistant nickel based alloys, high strength	2.4668	NiCr19Fe19NbMo	900-1400	Inconel 718 NiCr19Fe19Nb5Mo3	
H	Hartguss	Chilled cast iron		Ni-hard, Ampco	300-600 HB	Ni-hard, Ampco
	Gehärteter Stahl	Hardened steel			45-52 HRC	
					53-59 HRC	

	Linsenprofil Lens shape					Tonnenprofil Barrel shape					Konisches Profil Form A und B Conical taper shape A and B					Ovales Profil Oval shape				
	Schnitt- geschw. Cut. speed v_c (m/min)	Vorschub pro Zahn Feed per tooth f_z (mm/z.)				Schnitt- geschw. Cut. speed v_c (m/min)	Vorschub pro Zahn Feed per tooth f_z (mm/z.)				Schnitt- geschw. Cut. speed v_c (m/min)	Vorschub pro Zahn Feed per tooth f_z (mm/z.)				Schnitt- geschw. Cut. speed v_c (m/min)	Vorschub pro Zahn Feed per tooth f_z (mm/z.)			
		6	10	12	16		6	10	12	16		6	10	12	16		6	10	12	16
	275	0,03	0,04	0,05	0,06	275	0,03	0,05	0,06	0,08	275	0,02	0,03	0,04	0,05	275	0,03	0,05	0,06	0,08
	245	0,03	0,04	0,05	0,06	250	0,03	0,04	0,05	0,06	250	0,02	0,03	0,04	0,05	250	0,03	0,04	0,05	0,06
	150	0,01	0,02	0,03	0,03	100	0,01	0,02	0,03	0,03	100	0,01	0,02	0,03	0,03	100	0,01	0,02	0,03	0,03
	220	0,03	0,04	0,05	0,06	220	0,03	0,04	0,05	0,06	220	0,02	0,03	0,04	0,05	220	0,03	0,04	0,05	0,06
	200	0,03	0,04	0,05	0,06	250	0,03	0,04	0,05	0,06	250	0,02	0,03	0,04	0,05	250	0,03	0,04	0,05	0,06
	150	0,01	0,02	0,03	0,03	160	0,01	0,02	0,03	0,03	160	0,01	0,02	0,03	0,03	160	0,01	0,02	0,03	0,03
	180	0,01	0,02	0,03	0,03	200	0,01	0,02	0,03	0,03	200	0,01	0,02	0,03	0,03	200	0,01	0,02	0,03	0,03
	120	0,01	0,02	0,03	0,03	80	0,01	0,02	0,03	0,03	80	0,01	0,02	0,03	0,03	80	0,01	0,02	0,03	0,03
	90	0,01	0,01	0,01	0,02	60	0,01	0,01	0,01	0,02	60	0,01	0,01	0,01	0,02	60	0,01	0,01	0,01	0,02
	300	0,03	0,05	0,06	0,08	280	0,03	0,05	0,06	0,08	280	0,03	0,04	0,05	0,06	280	0,03	0,05	0,06	0,08
	275	0,03	0,04	0,05	0,06	250	0,03	0,04	0,05	0,06	250	0,03	0,04	0,05	0,06	250	0,03	0,04	0,05	0,06
	250	0,03	0,04	0,05	0,06	230	0,03	0,04	0,05	0,06	230	0,03	0,04	0,05	0,06	230	0,03	0,04	0,05	0,06
	230	0,03	0,04	0,05	0,06	220	0,03	0,04	0,05	0,06	220	0,03	0,04	0,05	0,06	220	0,03	0,04	0,05	0,06
	700	0,03	0,05	0,06	0,08	600	0,03	0,05	0,06	0,08	600	0,03	0,04	0,05	0,06	600	0,03	0,05	0,06	0,08
	275	0,03	0,04	0,05	0,06	180	0,03	0,04	0,05	0,06	180	0,03	0,04	0,05	0,06	180	0,03	0,04	0,05	0,06
	150	0,02	0,03	0,04	0,05	100	0,01	0,01	0,01	0,02	100	0,02	0,03	0,04	0,05	100	0,02	0,03	0,04	0,05
	120	0,01	0,02	0,03	0,03	75	0,01	0,02	0,03	0,03	75	0,01	0,02	0,03	0,03	75	0,01	0,02	0,03	0,03
	75	0,01	0,01	0,01	0,02	100	0,01	0,01	0,01	0,02	100	0,01	0,01	0,01	0,02	100	0,01	0,01	0,01	0,02
	200	0,02	0,03	0,04	0,05	200	0,02	0,03	0,04	0,05	200	0,01	0,02	0,03	0,03	200	0,02	0,03	0,04	0,05

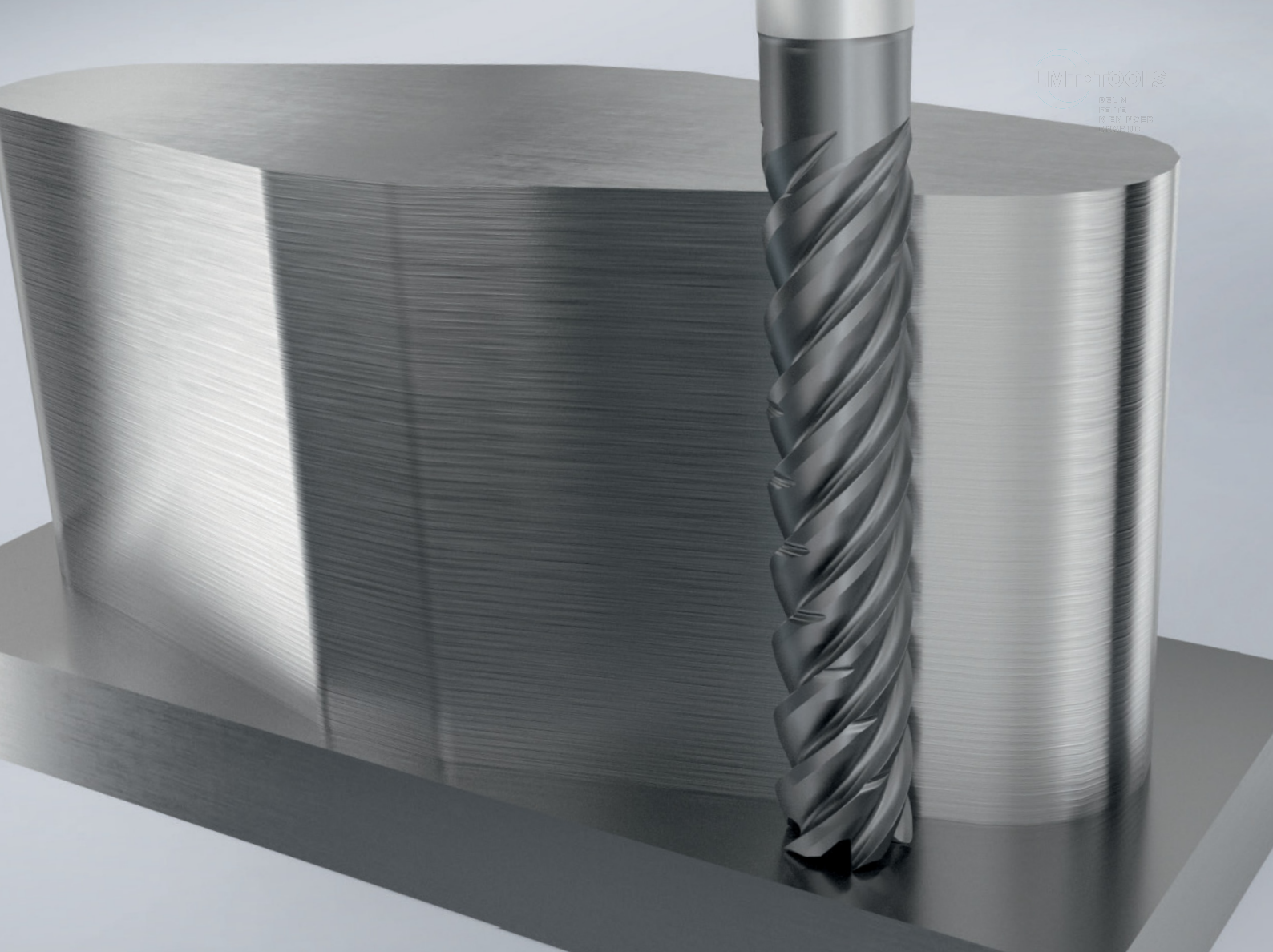

TPC – Trochoidal Performance Cutter

Die perfekte Lösung
für trochoidales Fräsen
The Perfect Solution
for Trochoidal Milling

Mit unserem TPC-Programm (Trochoidal Performance Cutter) bieten wir Ihnen eine bahnbrechende Lösung, die für exzellentes Trochoidalfräsen in einer Vielzahl von Materialien entwickelt wurde. Egal, ob Sie mit Stahl (ISO-P), rostfreiem Stahl (ISO-M), Guss (ISO-K), oder hochwarmfesten Stählen/Superlegierungen (ISO-S) arbeiten. Mit ihrem maximalen axialen Eingriff ($3 \times \varnothing$ und $5 \times \varnothing$) und sorgfältig abgestimmten Geometrien liefern alle Fräser der TPC-Familie makellose Leistungen in verschiedenen Bearbeitungsanwendungen.

Kontaktieren Sie uns jetzt und profitieren Sie von den Vorteilen der TPC-Werkzeuge. Wir unterstützen Sie gerne auf dem Weg, Ihre Produktivität mit herausragender Frästechnik zu revolutionieren!

With our TPC (Trochoidal Performance Cutter) program, we offer you a cutting-edge solution designed for excellent trochoidal milling in a wide range of materials. Whether you are working with steel (ISO-P), stainless steel (ISO-M), cast iron (ISO-K) or high temperature steel or superalloys (ISO-S) – With their maximum axial depth of engagement ($3 \times \varnothing$ and $5 \times \varnothing$) and carefully matched geometries, all cutters in the TPC family deliver impeccable performance in various machining applications.

Contact us now and benefit from the advantages of TPC tools. We will be happy to support you on your way to revolutionize your productivity with outstanding milling technology!

Präzision, Effizienz und Zuverlässigkeit – Neu definiert **Precision, Efficiency and Reliability – Redefined**

Das Trochoidalfräsen hält besonders einzigartige Herausforderungen im Rahmen des Bearbeitungsprozesses bereit. Insbesondere das enorme Spanvolumen gilt als Hürde in Bezug auf den Späneabtransport.

Mit unserem TPC können Sie sich von spanbedingten Störungen verabschieden. Die Werkzeug-Anwendung kommt mit deutlich weniger Spanvolumen aus, ohne Abstriche bei der Produktivität zu machen. Zudem wird der Verschleiß auf ein Minimum reduziert, was die Lebensdauer des Werkzeugs erhöht und den Bedarf an häufigen Austauschen verringert.

Die hohe Anzahl der Spanbrecher vermindert Vibrationen erheblich und verbessert die Stabilität und Präzision während des Bearbeitungsprozesses. Nicht zuletzt garantiert die versetzte Anordnung der Spanbrecher saubere und glatte Oberflächen, wodurch die Werkzeuge ideal für nachfolgende Finish-Bearbeitungen sind.

Ihre Vorteile:

- Minimierter Verschleißentwicklung
- Dämpfung von Vibrationen
- Saubere und glatte Oberflächen

Trochoidal milling faces particularly unique challenges in the machining process. Especially the enormous chip volume is considered a hurdle in terms of chip removal.

With our TPC, you can say goodbye to chip-related disturbances. The tool application gets by with significantly less chip volume without sacrificing productivity. In addition, wear is reduced to a minimum, which increases tool life and reduces the need for frequent replacements.

The high number of chipbreakers significantly reduces vibrations and improves stability and precision during the machining process. Last but not least, the staggered arrangement of chipbreakers guarantees clean and smooth surfaces, making the tools ideal for subsequent finishing operations.

Your benefits:

- Minimized abrasion
- Damping of vibrations
- Clean and smooth surfaces

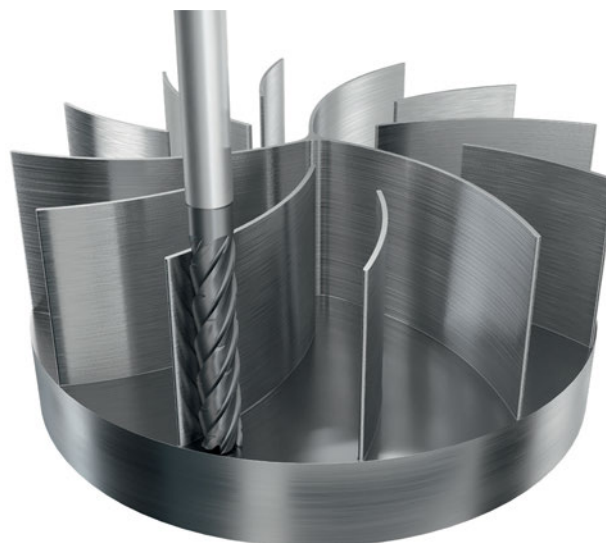

TPC 01 Rougher 45 P
Schaftfräser
End mill

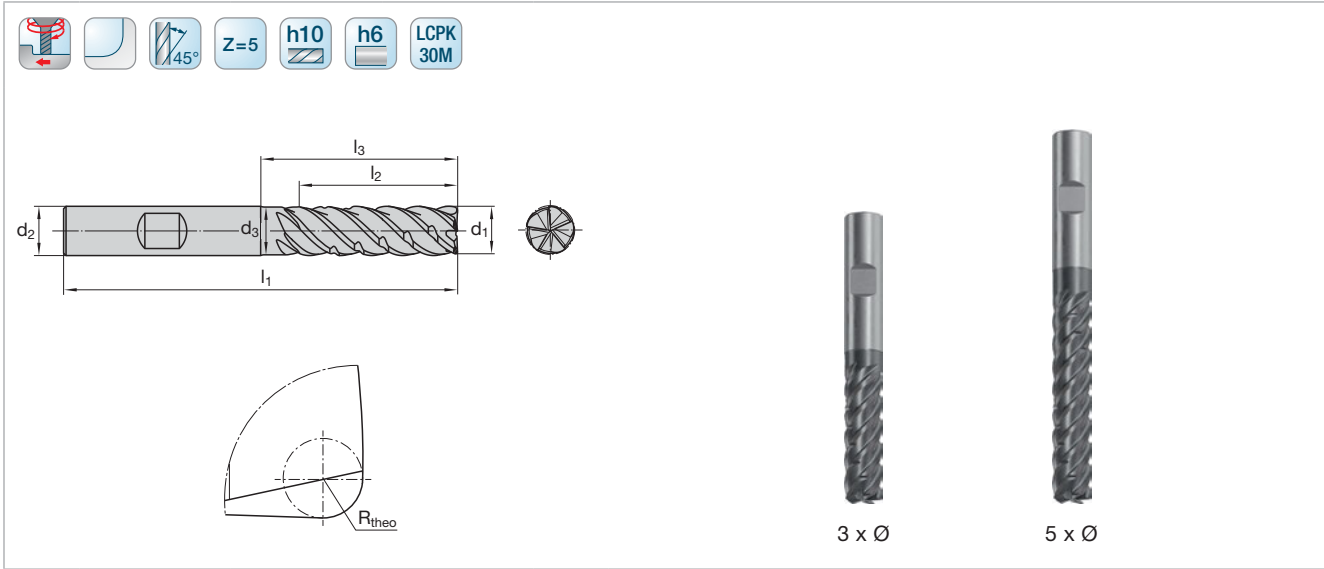

Katalog-Nr. Cat.-No.								TPC01-P-B		
P								■		
M										
K								■		
N										
S										
H										
d ₁	d ₃	l ₂	l ₁	l ₃	d ₂	z	R _{theo} (+0,05)	Ident No.	LMT-Code	
3 x Ø										
6	5,8	20	65	27	6	5	0,5	7437616	EM-TPC01 P6.0x20/27 5R0.5HB	
8	7,8	26	70	33	8	5	0,5	7437617	EM-TPC01 P8.0x26/33 5R0.5HB	
10	9,7	32	80	39	10	5	0,5	7437618	EM-TPC01 P10.0x32/39 5R0.5HB	
12	11,7	38	93	47	12	5	0,5	7437619	EM-TPC01 P12.0x38/47 5R0.5HB	
16	15,7	50	108	59	16	5	0,5	7437620	EM-TPC01 P16.0x50/59 5R0.5HB	
20	19,7	62	126	75	20	5	0,5	7437621	EM-TPC01 P20.0x62/75 5R0.5HB	
5 x Ø										
6	5,8	32	80	43	6	5	0,5	7437622	EM-TPC01 P6.0x32/43 5R0.5HB	
8	7,8	42	90	53	8	5	0,5	7437623	EM-TPC01 P8.0x42/53 5R0.5HB	
10	9,7	52	100	59	10	5	0,5	7437624	EM-TPC01 P10.0x52/59 5R0.5HB	
12	11,7	62	120	74	12	5	0,5	7437625	EM-TPC01 P12.0x62/74 5R0.5HB	
16	15,7	82	140	91	16	5	0,5	7437626	EM-TPC01 P16.0x82/91 5R0.5HB	
20	19,7	102	165	114	20	5	0,5	7437627	EM-TPC01 P20.0x102/114 5R0.5HB	

Schnittwertempfehlungen ab Seite 124
 Cutting data recommendations starting page 124

■ = Hauptanwendung First choice
 □ = Nebenanwendung Second choice

TPC 01 Rougher 35 M
Schaftfräser
End mill

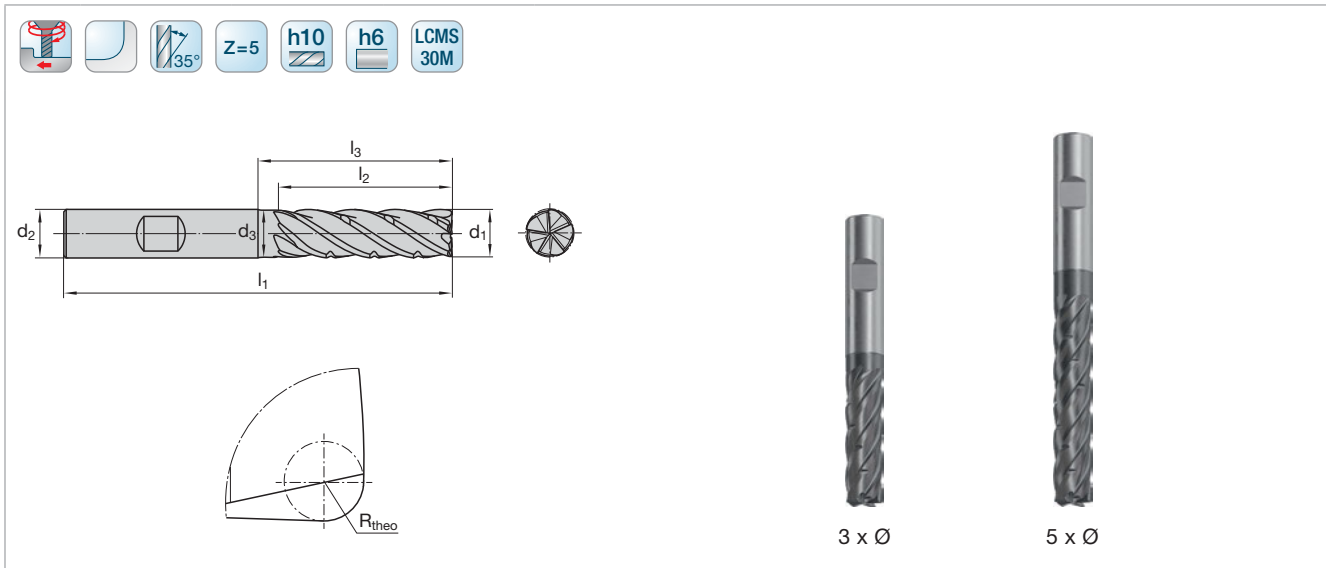

Katalog-Nr. Cat.-No.								TPC01-M-B		
P										
M								■		
K										
N										
S								■		
H										
d ₁	d ₃	l ₂	l ₁	l ₃	d ₂	z	R _{theo} (+0,05)	Ident No.	LMT-Code	
3 x Ø										
6	5,8	20	65	27	6	5	0,5	7437628	EM-TPC01 M6.0x20/27 5R0.5HB	
8	7,8	26	70	33	8	5	0,5	7437629	EM-TPC01 M8.0x26/33 5R0.5HB	
10	9,7	32	80	39	10	5	0,5	7437630	EM-TPC01 M10.0x32/39 5R0.5HB	
12	11,7	38	93	47	12	5	0,5	7437631	EM-TPC01 M12.0x38/47 5R0.5HB	
16	15,7	50	108	59	16	5	0,5	7437632	EM-TPC01 M16.0x50/59 5R0.5HB	
20	19,7	62	126	75	20	5	0,5	7437633	EM-TPC01 M20.0x62/75 5R0.5HB	
5 x Ø										
6	5,8	32	80	43	6	5	0,5	7437634	EM-TPC01 M6.0x32/43 5R0.5HB	
8	7,8	42	90	53	8	5	0,5	7437635	EM-TPC01 M8.0x42/53 5R0.5HB	
10	9,7	52	100	59	10	5	0,5	7437636	EM-TPC01 M10.0x52/59 5R0.5HB	
12	11,7	62	120	74	12	5	0,5	7437637	EM-TPC01 M12.0x62/74 5R0.5HB	
16	15,7	82	140	91	16	5	0,5	7437638	EM-TPC01 M16.0x82/91 5R0.5HB	
20	19,7	102	165	114	20	5	0,5	7437639	EM-TPC01 M20.0x102/114 5R0.5HB	

Schnittwertempfehlungen ab Seite 124
 Cutting data recommendations starting page 124

■ = Hauptanwendung First choice
 □ = Nebenanwendung Second choice

TPC 01 Rougher
Schnittwertempfehlungen
Cutting data recommendations

Werkstoff Material	Werkstoff-Nr. Material No.	DIN Bezeichnung Alt DIN Description Old	R _m /UTS (N/mm ²)	DIN Bezeichnung Neu DIN Description New	
P Nitrier- und Vergütungsstahl Nitriding steel and heat-treatment steel	1.7225	42CrMo4	950–1400	42CrMo4	
	1.2344	X40CrMoV5.1	–900	X40CrMoV5-1	
	1.4104	X12CrMoS17	500–950	X14CrMoS17	
	1.8504	34CrAl6	950–1400	34CrAl6	
	Werkzeugstahl Tool steel	1.2343	X38CrMoV5 1	950–1400	X37CrMoV5-1
		1.6580	30CrNiMo8	950–1400	30CrNiMo8
		1.2379	X155CrVMo12 1	–950	X153CrMoV12-1
		1.2080	X210Cr12	950–1400	X210Cr12
		1.2311	40CrMnMo7	–1100	40CrMnMo7
		1.2312	40CrMnNiMoS8.6	–1150	40CrMnNiMoS8-6
		1.2738	45CrMnNiMo8.6.4	950–1150	45CrMnNiMo8-6-4
		1.2358	60CrMoV18-5	850–1000	60CrMoV18-5
1.2714	55NiCrMoV7	1100–1350	55NiCrMoV7		
K Grauguss Grey cast iron	0.6025	GG25	100–400 (120–260 HB)	EN-GJ1-250	
	Legierter Grauguss Alloyed grey cast iron	0.6678	GGL-NiCr35 2	150–250 (160–230 HB)	EN-GJLA-XNiCr35-2
		0.7060	GGG60	400–800	EN-GJS-600-3
	Sphäroguss Nodular cast iron	0.7070	GGG70L	(120–310 HB)	EN-GJS-700-2U
Temperguss Malleable cast iron	0.8155	GTS55	350–700 (150–280 HB)	EN-GJMB-550-4	
M Rost- und säurebeständiger Stahl, austenitisch Stainless steel, austenitic	1.4301	X2CrNiMo17-12-2	500–950	X5CrNiMo18-10	
	1.4404	X6CrNiMoTi17-12-2		X2CrNiMo17-12-2	
	1.4571	X10CrNiMoTi18		X10CrNiMoTi18	
	Rost- und säurebeständiger Stahl, ferritisch, martensitisch Stainless steel, ferritic, martensitic	1.4024	X15Cr13	500–950	X15Cr13
		1.4057	X17CrNi16-2		X17CrNi16-2
		1.4122	X35CrMo17		X35CrMo17
Rost- und säurebeständiger Stahl, martensitisch aushärtbar Stainless steel, martensitic steel	1.2709	X3NiCoMoTi18-9-5	800–1000	X3NiCoMoTi18-9-5	
	1.4542	X5CrNiCuNb16-4		X5CrNiCuNb16-4	
	1.4568	X7CrNiAl17-7		X7CrNiAl17-7	
S Titan-Legierungen, mittelfest Titanium alloys, medium strength	3.7164	TiAl6V4	–950	Ti6AlV4	
	3.7115	TiAl5Sn2,5		TiAl5Sn2-5	
	Titan-Legierungen, hochfest Titanium alloys, high strength	3.7174	TiAl6Sn2	900–1400	TiAl6V6Sn2
	Nickelbasis-Legierungen, mittelfest Nickel based alloys, medium strength	2.4670	NiCr12Al6MoNb	–950	NiCr12Al6MoNb
Nickelbasis-Legierungen, hochwarmfest Heat resistant nickel based alloys, high strength		2.4668	NiCr19Fe19NbMo	900–1400	Inconel 718 NiCr19Fe19Nb5Mo3

Die angegebenen Schnittwerte sind Startwerte und müssen auf die vorhandenen Bedingungen abgestimmt werden.
 The specified cutting data are start values and must be adjusted to the existing conditions.

¹⁾ Bei Ausführung 5 x Ø sind die kleinsten f_z-Werte als Startwert zu verwenden.
¹⁾ For the 5 x Ø version, the smallest f_z values are to be used as starting values.



3 x Ø







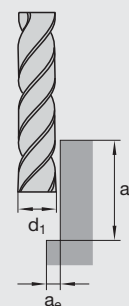

a_e Stahl Steel = 0,1 x d₁
 a_e Rostfreier Stahl Stainless Steel = 0,05 x d₁
 a_{p max} = 3 x d₁

5 x Ø

a_e Stahl Steel = 0,05 x d₁
 a_e Rostfreier Stahl Stainless Steel = 0,03 x d₁
 a_{p max} = 5 x d₁



a_e = Schnittbreite in mm
 a_p = Schnitttiefe in mm
 d₁ = Durchmesser in mm
 a_e = Width of cut in mm
 a_p = Depth of cut in mm
 d₁ = Cutter diameter in mm

Eingriffswinkel Pressure angle β		Radiale Zustellung Radial depth of cut a_e		Schnittgeschwindigkeit Cutting speed v_c (m/min)		Fräserdurchmesser Cutting diameter (mm) Vorschub pro Zahn f_z Feed per tooth f_z (mm/z.) ¹⁾		
3 x Ø	5 x Ø	3 x Ø	5 x Ø	3 x Ø	5 x Ø	Ø 6-8	Ø 10-12	Ø 16-20
35-45°	25°	0,1 x d ₁ 	0,05 x d ₁ 	280-320	200-250	0,06-0,1	0,1-0,15	0,15-0,25
				280-320	200-250	0,06-0,1	0,1-0,15	0,15-0,25
				280-320	200-250	0,06-0,1	0,1-0,15	0,15-0,25
				280-320	200-250	0,06-0,1	0,1-0,15	0,15-0,25
				250-300	180-230	0,05-0,1	0,1-0,15	0,15-0,25
				250-300	180-230	0,05-0,1	0,1-0,15	0,15-0,25
				250-300	180-230	0,05-0,1	0,1-0,15	0,15-0,25
				250-300	180-230	0,05-0,1	0,1-0,15	0,15-0,25
				250-300	180-230	0,05-0,1	0,1-0,15	0,15-0,25
				250-300	180-230	0,05-0,1	0,1-0,15	0,15-0,25
				230-280	160-200	0,05-0,1	0,08-0,15	0,12-0,2
				230-280	160-200	0,05-0,1	0,08-0,15	0,12-0,2
35-45°	25°	0,1 x d ₁ 	0,05 x d ₁ 	400-450	320-370	0,2-0,25	0,25-0,3	0,3-0,4
				350-400	280-230	0,15-0,2	0,2-0,25	0,25-0,35
				300-350	240-290	0,15-0,2	0,2-0,25	0,25-0,35
				280-320	220-260	0,10-0,15	0,15-0,2	0,2-0,3
25°	20°	0,05 x d ₁ 	0,03 x d ₁ 	120-140	100-120	0,05-0,12	0,08-0,15	0,12-0,2
				100-140	80-120	0,05-0,1	0,08-0,12	0,1-0,2
				80-120	70-100	0,05-0,1	0,08-0,12	0,1-0,2
25°	20°	0,05 x d ₁ 	0,03 x d ₁ 	100-120	90-110	0,03-0,07	0,06-0,1	0,12-0,16
				80-100	70-90	0,03-0,07	0,06-0,1	0,12-0,16
				35-55	25-35	0,03-0,07	0,06-0,1	0,12-0,16
				25-35	20-30	0,03-0,07	0,06-0,1	0,12-0,16

 Trockenbearbeitung, Pressluftkühlung ist vorteilhaft
Dry machining, Compressed air cooling is advantageous

 Nassbearbeitung, auf ausreichende Emulsionszuführung achten
Wet machining, Ensure sufficient emulsion supply

CAM-Systeme rechnen mit einer konstanten mittleren Spandicke, um den Prozess stabil und vibrationsarm zu halten.
CAM systems calculate with a constant average chip thickness to keep the process stable and low-vibration.

CAM	
Konstante h_m variabler Vorschub Constant h_m variable feed	$h_m = f_z \cdot \sqrt{\frac{a_e}{D}}$

CNC	
Konstante f_z variable mittlere Spandicke Constant f_z variable average chip thickness	$f_z = \frac{v_f}{z \cdot n}$

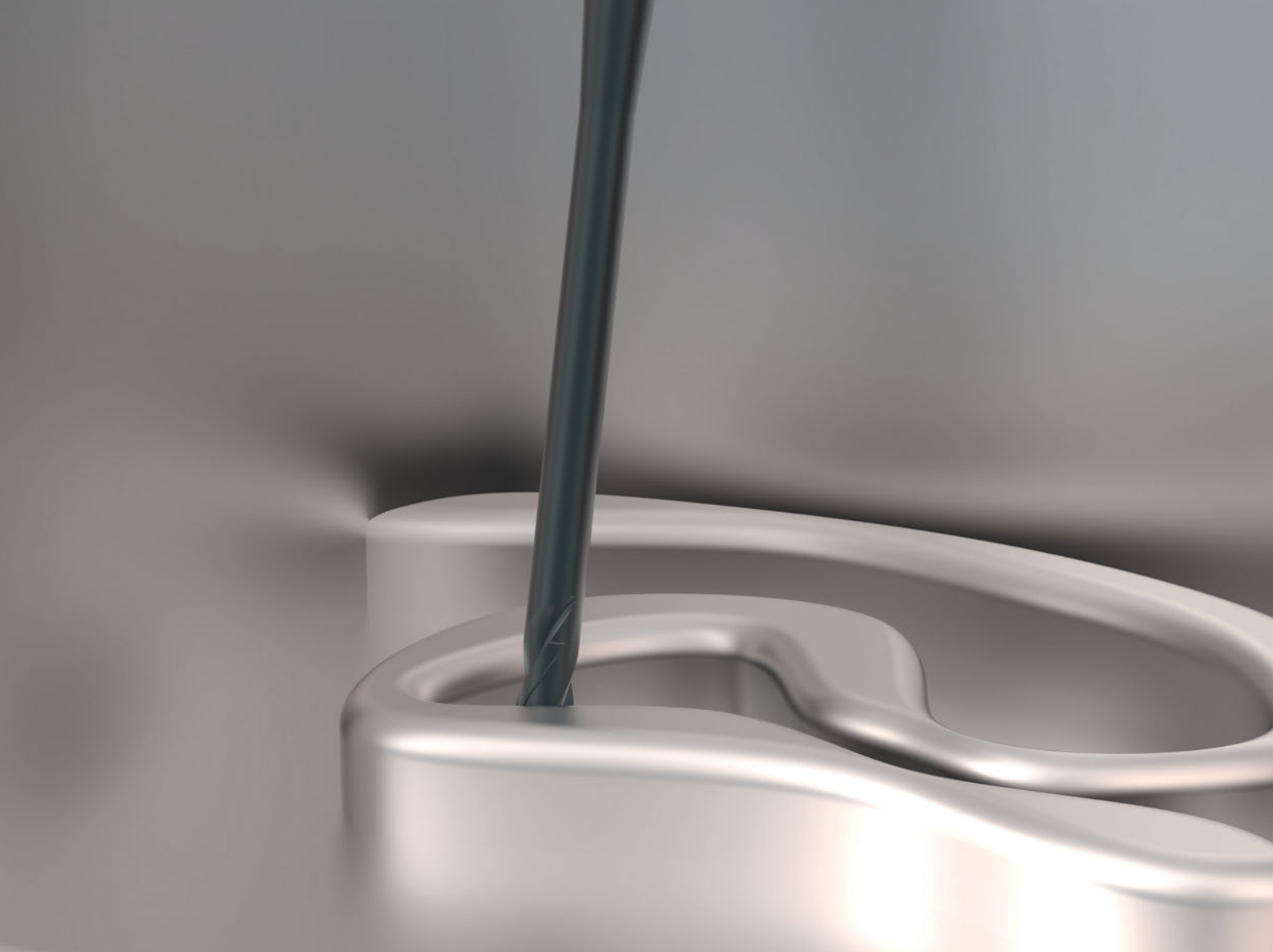

MIC – Micro Cutter

Erleben Sie Präzision
in Perfektion
Experience Precision
in Perfection

Unser revolutionäres Mikrofräser-Programm eröffnet Ihnen eine völlig neue Dimension in der Welt der Bearbeitung mit Präzisionswerkzeugen. Die MIC-Produkte gelten als Inbegriff von Vielseitigkeit und Zuverlässigkeit. Ganz gleich, ob Sie mit hochzähem oder gehärtetem Stahl arbeiten möchten, sogar schwer zu bearbeitende Materialien sind für unsere MIC-Werkzeuge eine Leichtigkeit. Dabei wurden sie speziell für herausragende Leistungen in Form- und Matrizenanwendungen entwickelt. So setzen scharfe und widerstandsfähige Zähne neue Maßstäbe in der Präzisionsbearbeitung. Keine Herausforderung ist zu groß, wenn es darum geht, Ihren Ansprüchen gerecht zu werden.

Erleben Sie faszinierende Ergebnisse was Ihre Oberflächen betrifft und erzielen Sie stets eine Veredelung, die Ihre Werkstücke zum Strahlen bringt

Our revolutionary micro milling cutter program opens up a whole new dimension in the world of machining with precision tools. MIC products are considered the epitome of versatility and reliability. Whether you want to work with high toughness or hardened steel, even difficult-to-machine materials are a simple matter for our MIC tools. At the same time, they are specifically designed for outstanding performance in mold and die applications. As a result, sharp and durable teeth set new standards in precision machining. No challenge is too great when it comes to meeting your needs.

Experience fascinating results regarding your surfaces and always achieve a finish that makes your workpieces shine.

Exzellente Leistung: Langlebig und vielseitig mit engsten Toleranzen **Excellent Performance: Durable and Versatile with Tight Tolerances**

Die MIC-Werkzeuge bestechen durch eine beeindruckende Standzeit und eignen sich für die Bearbeitung von hochzähem Stahllegierungen bis hin zu hartem Stahl > 55 HRC. Dank des extra langen Halses haben Sie die Freiheit, in verschiedenen Tiefen zu arbeiten. Von Formen bis hin zu Matrizen – mit unserem MIC-Programm erreichen Sie mühelos beispiellose Ergebnisse.

Präzision ist unsere Leidenschaft – und das zeigt sich in den engen Toleranzen unserer MIC-Werkzeuge ($\pm 0,007$ mm). Verlassen Sie sich darauf, dass Ihre Bearbeitungsergebnisse die höchsten Qualitätsstandards erfüllen und Ihre Erwartungen übertreffen.

Sind Sie bereit, die Grenzen zu sprengen? Tauchen Sie in die MIC-Welt ein und erleben Sie die Faszination der Präzision und Vielseitigkeit. Gemeinsam heben wir Ihre Bearbeitungsergebnisse auf ein völlig neues Niveau!

Ihre Vorteile:

- Hohe Standzeiten
- Begeisternde Oberflächengüte
- Scharfe und widerstandsfähige Zähne für präziseste Ergebnisse in jeder Tiefe
- Engste Toleranzen zur Erfüllung höchster Qualitätsstandards

The MIC tools excel with an impressive tool life and are suitable for machining high-toughness steel alloys up to hard steel > 55 HRC. Thanks to the extra-long neck, you have the freedom to work at different depths. From molds to dies - with our MIC range you can effortlessly achieve unprecedented results.

Precision is our passion – and it shows in the tight tolerances of our MIC tools (± 0.007 mm). Count on your machining results to meet the highest quality standards and exceed your expectations.

Are you ready to push the boundaries? Immerse yourself in the MIC world and experience the fascination of precision and versatility. Together, we'll take your machining results to a whole new level!

Your benefits:

- Long tool life
- Inspiring surface quality
- Sharp and resistant flute for the most precise results at any depth
- Tight tolerances to meet the highest quality standards

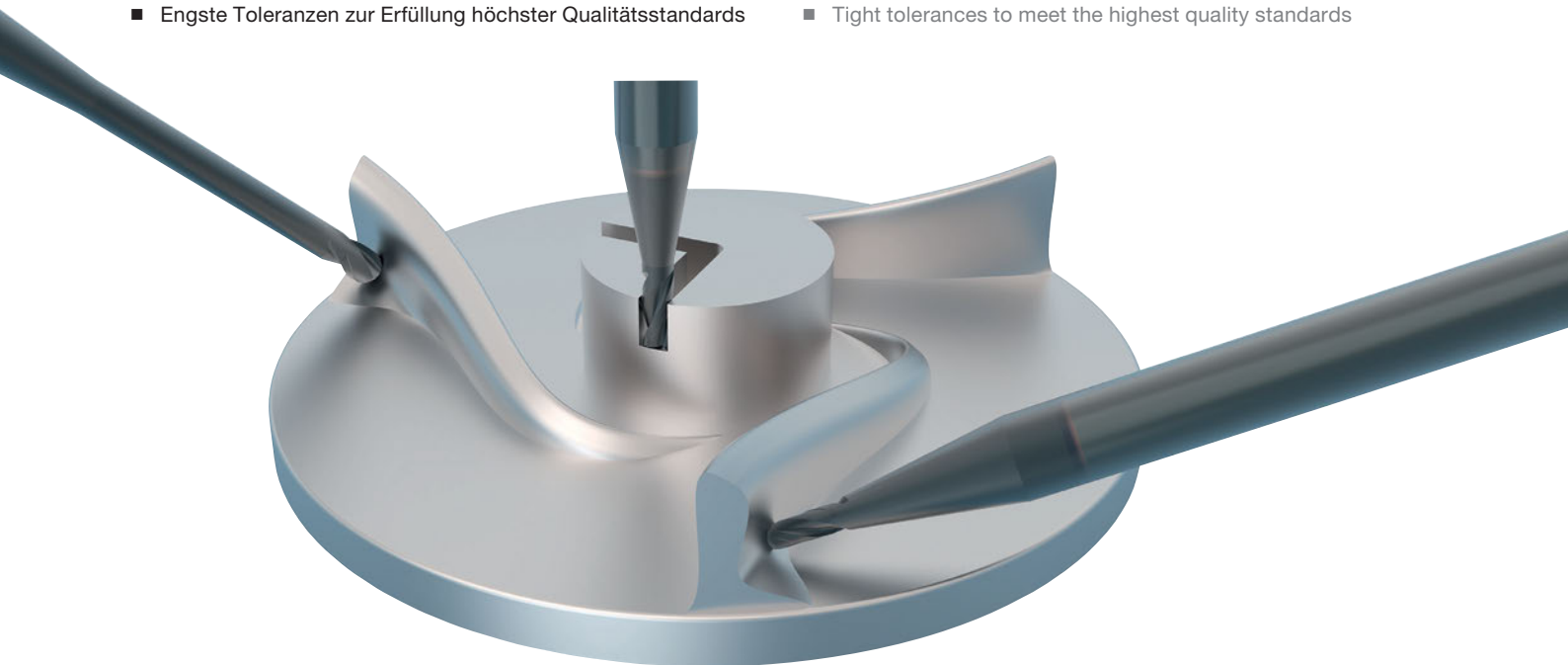

MIC 01 Toric-Finisher 30 U
Mikrofräser 3-schneidig Torisch kurz
Toric micro cutter 3 flute short

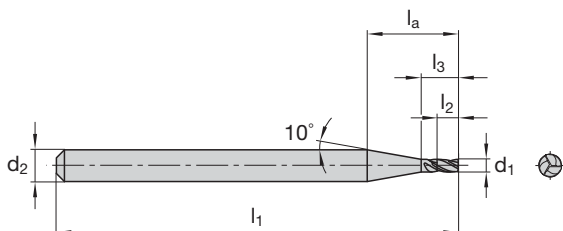

Katalog-Nr. Cat.-No.		MIC01-U-A								
P		■								
M		■								
K		■								
N		■								
S										
H										
d ₁	l ₂	l ₁	l ₃	l _a	d ₂	z		Ident No.	LMT-Code	
kurz short										
0,5	1,5	38	2,2	9,3	3	3	S	7434450	EM-MIC01 U005x015/0022 3S	
0,6	1,5	38	2,3	9,1	3	3	S	7434451	EM-MIC01 U006x015/0023 3S	
0,8	1,5	38	2,6	8,8	3	3	S	7434452	EM-MIC01 U008x015/0026 3S	
1	2	38	3,2	8,9	3	3	S	7434453	EM-MIC01 U010x020/0032 3S	
1,2	2	38	3,5	8,6	3	3	S	7434454	EM-MIC01 U012x020/0035 3S	
1,5	2	38	3,7	8	3	3	S	7434455	EM-MIC01 U015x020/0037 3S	
2	8	38	10	12,8	3	3	S	7434456	EM-MIC01 U020x080/0100 3S	
2,5	9	38	11,5	12,9	3	3	S	7434457	EM-MIC01 U025x090/0115 3S	
3	12	38	12	17	3	3	S	7434458	EM-MIC01 U030x120/0120 3S	





Schnittwertempfehlungen ab Seite 130
 Cutting data recommendations starting page 130

■ = Hauptanwendung First choice
 □ = Nebenanwendung Second choice



Bildquelle Sources: Firma Work NC-Dental®

MIC 01 Toric-Finisher 30 U
Schnittwertempfehlungen
Cutting data recommendations

Werkstoff Material		Werkstoff-Nr. Material No.	R _m /UTS (N/mm ²)	DIN Bezeichnung DIN Description	Kühlung Coolant	Schnittgeschwindigkeit Cutting speed v _c (m/min)					
P1	Unlegierter Baustahl + Automatenstahl Plain carbon steel + free cutting steel	1.0037 1.1121	< 500	St37-2 Ck10		150–200					
	P2	Vergütungsstahl, mittelfest Heat-treatment steel, medium strength	1.7225 1.1191	42CrMo4-NT Ck45		120–160					
	P3	Werkzeugstahl Tool steel	1.2343	> 1000		X38CrMoV5 1 Toolox33	90–150				
M1	Rost- und säurebeständiger Stahl, austenitisch Stainless steel, austenitic	1.4301 1.4404 1.4571	500–950	X5CrNi18-10 X2CrNiMo17-12-2 X6CrNiMoTi17-12-2		60–80					
		K1		Grauguss Grey cast iron			0.6025	100–400 (120–260 HB)	GG25		120–150
		K2		Sphäroguss Nodular cast iron			0.7060 0.7070	400–800 (120–310 HB)	GGG60 GGG70L		110–140
N1	Aluminiumlegierungen, langspanend < 5 % Si Aluminium alloys, long shipping < 5 % Si	3.3535 3.4365	< 500	AlMg3 AlZnMgCu1,5		500–2000					
	Kupferlegierungen Copper alloys										
	Thermoplaste Thermoplastics										
N2	Aluminiumlegierungen, langspanend < 5–10% Si Aluminium alloys, long shipping < 5–10 % Si	3.2134	500–1000	G-ALSi5Cu1Mg		500–1500					
	Kupferlegierungen Copper alloys										

f_z information is for side milling. For slot milling reduce f_z by 20 %.

Lower value of cutting speed is used for high stock removal applications or for higher hardness (machinability) within group.

Higher value of cutting speed is used for finishing applications or for lower hardness (machinability) within group.

For tools with reach > 3 x D, reduce f_z by 20 %

For tools with reach > 5 x D, reduce f_z by 30 %

For tools with reach > 10 x D, reduce v_c and f_z by 20–30 %



Trockenbearbeitung, Pressluftkühlung ist vorteilhaft
 Dry machining, Compressed air cooling is advantageous



Nassbearbeitung, auf ausreichende Emulsionszuführung achten
 Wet machining, Ensure sufficient emulsion supply

	Fräserdurchmesser Cutting diameter (mm)									Kantenfräsen Side milling		Nutenfräsen Slot milling
	Vorschub pro Zahn f_z Feed per tooth f_z (mm/z.) ¹⁾									a_p	a_e	a_p
	Ø 0,5	Ø 0,6	Ø 0,8	Ø 1,0	Ø 1,2	Ø 1,5	Ø 2,0	Ø 2,5	Ø 3,0			
	0,004	0,004	0,006	0,007	0,009	0,011	0,015	0,019	0,023	1 x D	0,1 x D	0,25 x D
	0,003	0,004	0,005	0,006	0,007	0,009	0,012	0,016	0,019	1 x D	0,1 x D	0,25 x D
	0,003	0,003	0,005	0,006	0,007	0,009	0,012	0,014	0,017	1 x D	0,1 x D	0,25 x D
	0,003	0,003	0,004	0,005	0,006	0,008	0,010	0,013	0,016	1 x D	0,1 x D	0,25 x D
	0,004	0,004	0,006	0,007	0,009	0,011	0,015	0,019	0,023	1 x D	0,1 x D	0,25 x D
	0,003	0,004	0,005	0,006	0,007	0,009	0,012	0,016	0,019	1 x D	0,1 x D	0,25 x D
	0,006	0,007	0,009	0,011	0,013	0,017	0,022	0,028	0,033	1 x D	0,1 x D	0,25 x D
	0,005	0,006	0,008	0,010	0,012	0,015	0,020	0,025	0,030	1 x D	0,1 x D	0,25 x D

Berechnungsformeln und Vorschubkorrekturfaktoren Calculation formula and feed correction factors

Drehzahl

Speed n (min⁻¹):

$$n = \frac{v_c \cdot 1000}{\pi \cdot d_1}$$

Vorschubgeschwindigkeit

Feed rate v_f (mm/min):

$$v_f = f_z \cdot z \cdot n \cdot f_1$$

a_e = Schnittbreite Width of cut in mm
 a_p = Schnitttiefe Depth of cut in mm
 d_1 = Durchmesser Cutter diameter in mm
 f_1 = Korrekturfaktor für Correction factor v_f
 f_z = Vorschub pro Zahn Feed per tooth in mm
 n = Drehzahl Speed in min⁻¹
 v_f = Vorschubgeschwindigkeit Feed rate in mm/min
 z = Anzahl der Schneiden No. of teeth

Vorschubkorrektur Feed correction f_1

		f_1
XS	extra kurz extra short	1,35
S	kurz short	1
L	lang long	0,8
XL	extra lang extra long	0,6

Einteilung Ausführungsängen Classification design length

		Verhältnis Relation l_3/d_1
XS	extra kurz extra short	< 3,0
S	kurz short	3,1–5,0
L	lang long	5,1–8,0
XL	extra lang extra long	8,1–20,0

Nutenfräsen Slot milling

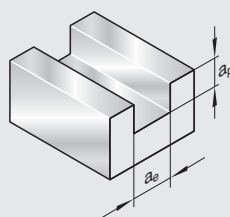

Kantenfräsen Side milling

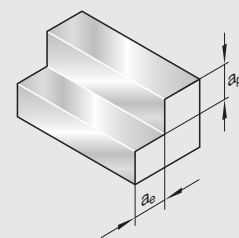

MIC 01 Toric-Finisher 30 PH
Mikrofräser 2-schneidig Torisch kurz/lang
Toric micro cutter 2 flute short/long

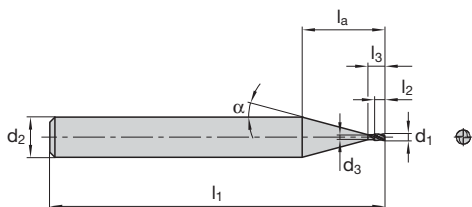



Katalog-Nr. Cat.-No.		MIC01-H-A									
P		■									
M											
K											
N											
S											
H		■									
d ₁	l ₂	l ₁	l ₃	l _a	d ₂	d ₃	z		Ident No.	LMT-Code	
kurz short											
0,3	0,4	50	0,4	16,6	6	-	2	XS	7434427	EM-MIC01 H003x004/0004 2S	
0,4	0,6	50	0,6	16,5	6	-	2	XS	7434428	EM-MIC01 H004x006/0006 2S	
0,5	0,7	50	1,5	11,9	6	0,44	2	XS	7434430	EM-MIC01 H005x007/0015 2S	
0,6	0,9	50	1,8	12	6	0,54	2	XS	7434431	EM-MIC01 H006x009/0018 2S	
0,8	1,2	50	2,4	12,2	6	0,74	2	XS	7434433	EM-MIC01 H008x012/0024 2S	
1	1,5	50	2,5	12,3	6	0,74	2	XS	7434435	EM-MIC01 H010x015/0025 2S	
1,2	1,8	50	3	12	6	1,14	2	XS	7434437	EM-MIC01 H012x018/0030 2S	
1,4	2,1	50	3,5	12,2	6	1,34	2	XS	7434439	EM-MIC01 H014x021/0035 2S	
1,5	2,3	50	3,5	12,2	6	1,34	2	XS	7434441	EM-MIC01 H015x023/0035 2S	
1,6	2,4	50	4	12,3	6	1,55	2	XS	7434443	EM-MIC01 H016x024/0040 2S	
1,8	2,7	50	4,5	12,4	6	1,75	2	XS	7434445	EM-MIC01 H018x027/0045 2S	
2	3	50	5	12,6	6	1,94	2	XS	7434447	EM-MIC01 H020x030/0050 2S	
2,5	3,7	50	5	11,7	6	2,4	2	XS	7434449	EM-MIC01 H025x037/0050 2S	
lang long											
0,5	0,7	60	2,5	12,9	6	0,44	2	S	7434429	EM-MIC01 H005x007/0025 2S	
0,8	1,2	60	4	13,8	6	0,74	2	S	7434432	EM-MIC01 H008x012/0040 2S	
1	1,5	60	5	14,4	6	0,94	2	S	7434434	EM-MIC01 H010x015/0050 2S	
1,2	1,8	60	6	15,1	6	1,14	2	S	7434436	EM-MIC01 H012x018/0060 2S	
1,4	2,1	60	7	15,7	6	1,34	2	S	7434438	EM-MIC01 H014x021/0070 2S	
1,5	2,3	60	7,5	16	6	1,44	2	S	7434440	EM-MIC01 H015x023/0075 2S	
1,6	2,4	60	8	16,3	6	1,54	2	S	7434442	EM-MIC01 H016x024/0080 2S	
1,8	2,7	60	9	16,9	6	1,74	2	S	7434444	EM-MIC01 H018x027/0090 2S	
2	3	60	10	17,6	6	1,94	2	S	7434446	EM-MIC01 H020x030/0100 2S	
2,5	3,7	60	12,5	19,1	6	2,44	2	S	7434448	EM-MIC01 H025x037/0125 2S	

Schnittwertempfehlungen ab Seite 134
 Cutting data recommendations starting page 134



■ = Hauptanwendung First choice
 □ = Nebenanwendung Second choice

MIC 01 Toric-Finisher 30 PH
Schnittwertempfehlungen
Cutting data recommendations

Werkstoff Material	Werkstoff-Nr. Material No.	R _m /UTS (N/mm ²)	DIN Bezeichnung DIN Description	Kühlung Coolant	Schnittgeschwindigkeit Cutting speed v _c (m/min)
P1 Stahl Steel	1.7225	500–1000	42CrMo4-NT		120–160
	1.1191		Ck45		
P2 Stahl Steel	1.2343	> 1000	X38CrMoV5 1 Toolox33		60–100
K1 Grey cast iron Grauguss	0.6025	100–400 (120–260 HB)	GG25		120–150
	0.6678	150–300 (160–230 HB)	GGL-NiCr35 2		
K2 Nodular cast iron Sphäroguss	0.7060	400–800 (120–310 HB)	GGG60		110–140
H1 Hartguss und gehärtete Stähle Chilled steel and Hardened steel		45–55 HRC	Ni-hard, Ampco		70–120
H2 Gehärtete Stähle Hardened steel		56–60 HRC			60–90

f_z information is for side milling. For slotting reduce f_z by 20 %.
 Lower value of cutting speed is used for high stock removal applications or for higher hardness (machinability) within group.
 Higher value of cutting speed is used for finishing applications or for lower hardness (machinability) within group.
 For tools with reach > 3 x D, reduce f_z by 20 %
 For tools with reach > 5 x D, reduce f_z by 30 %
 For tools with reach > 10 x D, reduce v_c and f_z by 20–30 %

Berechnungsformeln und Vorschubkorrekturfaktoren
Calculation formula and feed correction factors

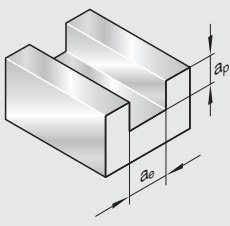
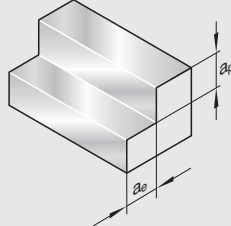
Drehzahl Speed n (min⁻¹): $n = \frac{v_c \cdot 1000}{\pi \cdot d_1}$	Vorschubkorrektur Feed correction f₁										
		<table border="1"> <thead> <tr> <th></th> <th>f₁</th> </tr> </thead> <tbody> <tr> <td>XS extra kurz extra short</td> <td>1,35</td> </tr> <tr> <td>S kurz short</td> <td>1</td> </tr> <tr> <td>L lang long</td> <td>0,8</td> </tr> <tr> <td>XL extra lang extra long</td> <td>0,6</td> </tr> </tbody> </table>		f ₁	XS extra kurz extra short	1,35	S kurz short	1	L lang long	0,8	XL extra lang extra long
	f ₁										
XS extra kurz extra short	1,35										
S kurz short	1										
L lang long	0,8										
XL extra lang extra long	0,6										
Vorschubgeschwindigkeit Feed rate v_f (mm/min): $v_f = f_z \cdot Z \cdot n \cdot f_1$	Einteilung Ausführungsängen Classification design length										
		<table border="1"> <thead> <tr> <th></th> <th>Verhältnis Relation l₃/d₁</th> </tr> </thead> <tbody> <tr> <td>XS extra kurz extra short</td> <td>< 3,0</td> </tr> <tr> <td>S kurz short</td> <td>3,1–5,0</td> </tr> <tr> <td>L lang long</td> <td>5,1–8,0</td> </tr> <tr> <td>XL extra lang extra long</td> <td>8,1–20,0</td> </tr> </tbody> </table>		Verhältnis Relation l ₃ /d ₁	XS extra kurz extra short	< 3,0	S kurz short	3,1–5,0	L lang long	5,1–8,0	XL extra lang extra long
	Verhältnis Relation l ₃ /d ₁										
XS extra kurz extra short	< 3,0										
S kurz short	3,1–5,0										
L lang long	5,1–8,0										
XL extra lang extra long	8,1–20,0										
Nutenfräsen Slot milling 	Kantenfräsen Side milling 										
	<p> a_e = Schnittbreite Width of cut in mm a_p = Schnitttiefe Depth of cut in mm d₁ = Durchmesser Cutter diameter in mm f₁ = Korrekturfaktor für Correction factor v_f f_z = Vorschub pro Zahn Feed per tooth in mm n = Drehzahl Speed in min⁻¹ v_f = Vorschubgeschwindigkeit Feed rate in mm/min Z = Anzahl der Schneiden No. of teeth </p>										

	Fräserdurchmesser Cutting diameter (mm)								Kantenfräsen Side milling		Nutenfräsen Slot milling
	Vorschub pro Zahn f_z Feed per tooth f_z (mm/z.) ¹⁾										
	Ø 0,4	Ø 0,5	Ø 0,6	Ø 0,8	Ø 1,0	Ø 1,5	Ø 2,0	Ø 2,5	a_p	a_e	a_p
	0,002	0,003	0,003	0,004	0,006	0,008	0,011	0,014	1,25 x D	0,25 x D	0,75 x D
	0,002	0,002	0,003	0,004	0,005	0,007	0,009	0,012	1,25 x D	0,25 x D	0,5 x D
	0,003	0,003	0,004	0,005	0,007	0,010	0,014	0,017	1,25 x D	0,25 x D	0,75 x D
	0,002	0,003	0,003	0,004	0,006	0,008	0,011	0,014	1,25 x D	0,25 x D	0,5 x D
	0,002	0,002	0,002	0,003	0,004	0,006	0,008	0,010	1,25 x D	0,25 x D	0,3 x D
	0,001	0,002	0,002	0,002	0,003	0,005	0,006	0,008	1,25 x D	0,25 x D	0,25 x D



Trockenbearbeitung, Pressluftkühlung ist vorteilhaft
Dry machining, Compressed air cooling is advantageous



Nassbearbeitung, auf ausreichende Emulsionszuführung achten
Wet machining, Ensure sufficient emulsion supply

MIC 01 Ball-Nose-Finisher 30 PH
Mikrofräser Kugelkopf – kurz
Ball nose micro cutter – short

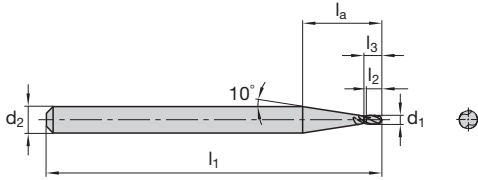

Katalog-Nr. Cat.-No.		MIC01-H-A									
P		■									
M											
K		■									
N											
S											
H		■									
d ₁	l ₂	l ₁	l ₃	l _a	d ₂	z	r		Ident No.	LMT-Code	
kurz short											
0,5	1,5	38	1,5	9	3	2	0,25	XS	7434397	EM-MIC01 H005x015/0015 2B0025	
0,6	1,7	38	2	9	3	2	0,3	XS	7434398	EM-MIC01 H006x017/0020 2B0030	
0,8	1,9	38	2,2	9	3	2	0,4	XS	7434399	EM-MIC01 H008x019/0022 2B0040	
1	2	38	2	9	3	2	0,5	XS	7434400	EM-MIC01 H010x020/0020 2B0050	
1,5	2,5	38	2,5	8,1	3	2	0,75	XS	7434401	EM-MIC01 H015x025/0025 2B0075	
2	3	38	3	7,1	3	2	1	XS	7434402	EM-MIC01 H020x030/0030 2B0100	
2,5	4	38	4	6,5	3	2	1,25	XS	7434403	EM-MIC01 H025x040/0040 2B0125	
3	5	38	5	10	3	2	1,5	XS	7434404	EM-MIC01 H030x050/0050 2B0150	

Schnittwertempfehlungen ab Seite 140
 Cutting data recommendations starting page 140

■ = Hauptanwendung First choice
 □ = Nebenanwendung Second choice

MIC 01 Ball-Nose-Finisher 30 PH
Mikrofräser Kugelkopf mit Halsfreistellung
Ball nose micro cutter with neck relief

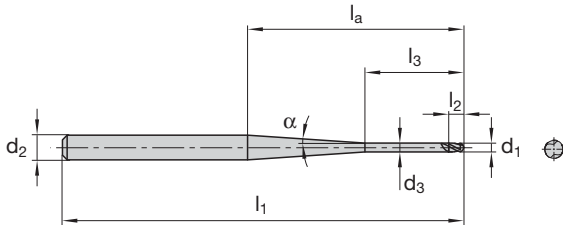

Katalog-Nr. Cat.-No.		MIC01-H-A										
P		■										
M												
K												
N												
S												
H		■										
d ₁	l ₂	l ₁	l ₃	l _a	α	d ₂	d ₃	z	r		Ident No.	LMT-Code
extra lang extra long												
1	1,6	65	6	37	3	4	0,95	2	0,5	L	7434418	EM-MIC01 H010x016/0060 2B0050
1	1,6	65	10	35	3	4	0,95	2	0,5	XL	7434419	EM-MIC01 H010x016/0100 2B0050
1	1,6	65	16	37	4	4	0,95	2	0,5	XL	7434420	EM-MIC01 H010x016/0160 2B0050
1,5	2,4	65	16	35	4	4	1,44	2	0,75	XL	7434421	EM-MIC01 H015x024/0160 2B0075
2	3,2	65	20	35	4	4	1,94	2	1	XL	7434422	EM-MIC01 H020x032/0200 2B0100
2	3,2	65	10	37	2	4	1,94	2	1	L	7434423	EM-MIC01 H020x032/0100 2B0100
2	3,2	65	16	37	3	4	1,94	2	1	L	7434424	EM-MIC01 H020x032/0160 2B0100
4	6	70	6	40,5	2	6	-	2	2	XS	7434425	EM-MIC01 H040x060/0060 2B0200
4	6	70	16	34	3	6	3,92	2	2	S	7434426	EM-MIC01 H040x060/0160 2B0200

Schnittwertempfehlungen ab Seite 140
 Cutting data recommendations starting page 140

■ = Hauptanwendung First choice
 □ = Nebenanwendung Second choice

MIC 01 Ball-Nose-Finisher 30 PH
Mikrofräser Kugelkopf mit Halsfreistellung
Ball nose micro cutter with neck relief

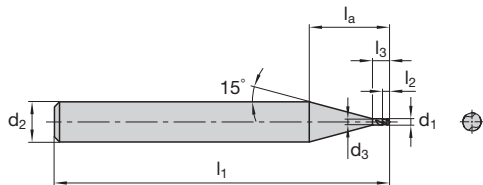

Katalog-Nr. Cat.-No.										MIC01-H-A			
P											■		
M													
K													
N													
S													
H											■		
d ₁	l ₂	l ₁	l ₃	l _a	d ₂	d ₃	z	r		Ident No.	LMT-Code		
lang long													
0,3	0,3	50	0,3	16,5	6	-	2	0,15	XS	7434405	EM-MIC01 H003x003/0003 2B0015		
0,4	0,4	50	0,4	16,3	6	-	2	0,2	XS	7434406	EM-MIC01 H004x004/0004 2B0020		
0,5	0,5	50	1,9	12,3	6	0,44	2	0,25	S	7434407	EM-MIC01 H005x005/0019 2B0025		
0,6	0,6	50	2,2	12,4	6	0,54	2	0,3	S	7434408	EM-MIC01 H006x006/0022 2B0030		
0,8	0,8	50	2,9	12,8	6	0,74	2	0,4	S	7434409	EM-MIC01 H008x008/0029 2B0040		
1	1	50	2,5	12	6	0,94	2	0,5	XS	7434410	EM-MIC01 H010x010/0025 2B0050		
1,2	1,2	50	3	12,1	6	1,14	2	0,6	XS	7434411	EM-MIC01 H012x012/0030 2B0060		
1,5	1,5	50	3,8	12,3	6	1,44	2	0,75	XS	7434412	EM-MIC01 H015x015/0038 2B0075		
1,6	1,6	50	4	12,3	6	1,54	2	0,8	XS	7434413	EM-MIC01 H016x016/0040 2B0080		
1,8	1,8	50	4,5	12,5	6	1,74	2	0,9	XS	7434414	EM-MIC01 H018x018/0045 2B0090		
2	2	50	5	12,6	6	1,94	2	1	XS	7434415	EM-MIC01 H020x020/0050 2B0100		
2,5	2,5	50	5	11,7	6	2,44	2	1,25	XS	7434416	EM-MIC01 H025x025/0050 2B0125		
3	3	50	6	11,8	6	2,9	2	1,5	XS	7434417	EM-MIC01 H030x030/0060 2B0150		

Schnittwertempfehlungen ab Seite 140
 Cutting data recommendations starting page 140

■ = Hauptanwendung First choice
 □ = Nebenanwendung Second choice

MIC 01 Ball-Nose-Finisher 30 PH
Schnittwertempfehlungen
Cutting data recommendations

Werkstoff Material		Werkstoff-Nr. Material No.	R _m /UTS (N/mm ²)	DIN Bezeichnung DIN Description	Kühlung Coolant	Schnittgeschwindigkeit Cutting speed v _c (m/min)
P2	Stahl Steel	1.7225	500-1000	42CrMo4-NT Ck45		210-230
		1.1191				270-310
						420-470
P3	Stahl Steel	1.2343	> 1000	X38CrMoV5 1 Toolox33		180-210
						240-270
						370-420
H1	Hartguss und gehärtete Stähle Chilled steel and Hardened steel		45-55 HRC	Ni-hard, Ampco		120-200
						160-280
						200-350
H2	Gehärtete Stähle Hardened steel		56-60 HRC			140-210
				180-260		
				220-320		
H3	Gehärtete Stähle Hardened steel		> 60 HRC			120-160
				150-200		
				180-250		

Die angegebenen Schnittwerte sind Startwerte und müssen auf die vorhandenen Bedingungen abgestimmt werden.
 The specified cutting data are start values and must be adjusted to the existing conditions.

Berechnungsformeln und Vorschubkorrekturfaktoren
Calculation formula and feed correction factors

Drehzahl Speed n (min ⁻¹): $n = \frac{v_c \cdot 1000}{\pi \cdot d_1}$	Vorschubkorrektur Feed correction f₁	
		f₁
Vorschubgeschwindigkeit Feed rate v _f (mm/min): $v_f = f_z \cdot z \cdot n \cdot f_1$	XS extra kurz extra short	1,35
	S kurz short L lang long XL extra lang extra long	1 0,8 0,6
Kopierfräsen Copy milling	Einteilung Ausführungslängen Classification design length	
		Verhältnis Relation l ₃ /d ₁
a _e = Schnittbreite Width of cut in mm a _p = Schnitttiefe Depth of cut in mm d ₁ = Durchmesser Cutter diameter in mm f ₁ = Korrekturfaktor für Correction factor v _f f _z = Vorschub pro Zahn Feed per tooth in mm n = Drehzahl Speed in min ⁻¹ v _f = Vorschubgeschwindigkeit Feed rate in mm/min z = Anzahl der Schneiden No. of teeth	XS extra kurz extra short	< 3,0
	S kurz short	3,1-5,0
	L lang long	5,1-8,0
	XL extra lang extra long	8,1-20,0

	Fräserdurchmesser Cutting diameter (mm)								Schruppen Roughing		Vorschlichten Semi finishing		Schlichten Finishing	
	Vorschub pro Zahn f_z Feed per tooth f_z (mm/z.)													
	Ø 0,5	Ø 0,6	Ø 0,8	Ø 1	Ø 1,5	Ø 2	Ø 2,5	Ø 3	a_p	a_e	a_p	a_e	a_p	a_e
	0,004	0,004	0,006	0,008	0,011	0,015	0,019	0,023	0,2 x D	0,1 x D				
	0,008	0,010	0,013	0,017	0,025	0,034	0,043	0,052			0,1 x D	0,05 x D		
	0,013	0,015	0,020	0,026	0,039	0,052	0,066	0,080					0,04 x D	0,04 x D
	0,004	0,004	0,006	0,007	0,011	0,014	0,018	0,021	0,2 x D	0,1 x D				
	0,008	0,009	0,012	0,016	0,024	0,031	0,040	0,048			0,1 x D	0,05 x D		
	0,012	0,014	0,019	0,024	0,036	0,048	0,061	0,073					0,04 x D	0,04 x D
	0,006	0,007	0,009	0,012	0,018	0,024	0,030	0,036	0,1 x D	0,075 x D				
	0,008	0,010	0,014	0,017	0,026	0,034	0,043	0,052			0,05 x D	0,04 x D		
	0,010	0,012	0,015	0,019	0,029	0,039	0,049	0,059					0,03 x D	0,03 x D
	0,007	0,008	0,011	0,013	0,020	0,027	0,034	0,041	0,05 x D	0,05 x D				
	0,008	0,009	0,012	0,015	0,023	0,031	0,039	0,047			0,03 x D	0,03 x D		
	0,008	0,010	0,013	0,016	0,025	0,033	0,041	0,050					0,02 x D	0,02 x D
	0,004	0,005	0,007	0,009	0,013	0,018	0,023	0,027	0,05 x D	0,05 x D				
	0,005	0,006	0,008	0,010	0,015	0,021	0,026	0,031			0,03 x D	0,03 x D		
	0,005	0,007	0,009	0,011	0,016	0,022	0,028	0,033					0,02 x D	0,02 x D



Trockenbearbeitung, Pressluftkühlung ist vorteilhaft
Dry machining, Compressed air cooling is advantageous

Vergleichstabelle: Werkstoffe
Comparison chart: materials

Werkstoff	Material	Werkstoff-Nr. Material No.	DIN Bezeichnung Alt DIN Description Old	R _m /UTS (N/mm ²)	DIN Bezeichnung Neu DIN Description New	
P	Unlegierter Baustahl + Automatenstahl	1.0570	St52-3	-700	S355J2G3	
		1.1730	C45	-800	C45U	
		1.0715	9SMn28	-700	11SMn30	
		1.1191 1.7219	Ck45 26CrMo4	500-950	C45E 26CrMo4-2	
	Vergütungsstahl, mittelfest	Heat-treatment steel, medium strength	1.7225 1.8159	42CrMo4 51CrV4	500-950	42CrMo4 51CrV4
	Stahlguss	Cast steel	1.0416	GS40	-950	GS40
	Einsatzstahl	Case hardening steel	1.7131	16MnCr5	-950	16MnCr5
	Rost- und säurebe- ständiger Stahl, ferritisch, martensitisch	Stainless steel, ferritic, martensitic	1.4006	X10Cr13	500-950	X12Cr13
			1.4104	X12CrMoS17		X14CrMoS17
			1.4122	X35CrMo17		X39CrMo17-1
	Vergütungsstahl, hochfest	Heat-treatment steel, high strength	1.7225 1.6580	42CrMo4 30CrNiMo8	950-1400	42CrMo4 30CrNiMo8
	Nitrierstahl, vergütet	Nitriding steel, heat treated	1.8504 1.2344	34CrAl6 X40CrMoV5.1	950-1400 -900	34CrAl6 X40CrMoV5-1
	Werkzeugstahl	Tool steel	1.2343	X38CrMoV5 1	950-1400	X37CrMoV5-1
			1.2379	X155CrVMo12 1	-950	X153CrMoV12-1
			1.2358	60CrMoV18-5	850-1000	60CrMoV18-5
			1.2080	X210Cr12	950-1400	X210Cr12
			1.2714	55NiCrMoV7	1100-1350	55NiCrMoV7
1.2311			40CrMnMo7	-1100	40CrMnMo7	
1.2312			40CrMnNiMoS8.6	-1150	40CrMnNiMoS8-6	
1.2316 1.2738			X38CrMo16 45CrMnNiMo8.6.4	-1100 950-1150	X38CrMo16 45CrMnNiMo8-6-4	
M	Rost- und säurebe- ständiger Stahl, austenitisch	1.4301	X2CrNiMo17-12-2	500-950	X5CrNiMo18-10	
		1.4404	X6CrNiMoTi17-12-2		X2CrNiMo17-12-2	
		1.4571	X10CrNiMoTi18		X10CrNiMoTi18	
	Rost- und säurebe- ständiger Stahl, martensitisch aushärtbar	Stainless steel, martensitic steel	1.2709	X3NiCoMoTi18-9-5	800-1000	X3NiCoMoTi18-9-5
			1.4542 1.4568	X5CrNiCuNb16-4 X7CrNiAl17-7		X5CrNiCuNb16-4 X7CrNiAl17-7
K	Grauguss	0.6025	GG25	100-400 (120-260 HB)	EN-GJI-250	
	Legierter Grauguss	0.6678	GGL-NiCr35 2	150-250 (160-230 HB)	EN-GJLA-XNiCr35-2	
	Sphäroguss	0.7060 0.7070	GGG60 GGG70L	400-800 (120-310 HB)	EN-GJS-600-3 EN-GJS-700-2U	
	Temperguss	0.8155	GTS55	350-700 (150-280 HB)	EN-GJMB-550-4	
N	Aluminium-Legierungen, kurzspanend	3.2581	G-AlSi12	-400	G-IGK-AlSi12	
	Aluminium-Legierungen, langspanend	3.3535	AlMg3	-550	AlMg3	
		3.4365	AlZnMgCu1,5		AlZnMgCu1,5	
	Kupfer-Legierungen, kurzspanend	2.0402	MS58	-500	CuZn40Pb2	
	Kupfer-Legierungen, langspanend	2.0320 2.0975	MS63 CuAl10Ni	300-500	CuZn37 CuAl10Fe5Ni5-C	
	Thermoplaste		PVC	40-70	PVC	
	Duroplaste		Bakelit, Melamin	20-40	Bakelit, Melamin	
Graphit						
S	Titan-Legierungen, mittelfest	3.7115	TiAl5Sn2,5	-950	TiAl5Sn2-5	
		3.7164	TiAl6V4		Ti6AlV4	
	Titan-Legierungen, hochfest	Titanium alloys, high strength	3.7174	TiAl6Sn2	900-1400	TiAl6V6Sn2
	Nickelbasis-Legierungen, mittelfest	Nickel based alloys, medium strength	2.4670	NiCr12Al6MoNb	-950	NiCr12Al6MoNb
	Nickelbasis-Legierungen, hochwarmfest	Heat resistant nickel based alloys, high strength	2.4668	NiCr19Fe19NbMo	900-1400	Inconel 718 NiCr19Fe19Nb5Mo3
H	Hartguss		Ni-hard, Ampco	300-600 HB	Ni-hard, Ampco	
	Gehärteter Stahl			45-52 HRC		
				53-59 HRC 60-65 HRC		

Spez. Schnittkraft Specific cutting force kc 1.1 (N/mm ²)	Schnittkraft-Exponent Cutting Force exponent m _c	Großbritannien Great Britain		Frankreich France	Italien Italy	Schweden Sweden	Spanien France	Japan Japan	USA USA	Russland Russia	Leistungs-faktor Efficiency factor LF = $\frac{\text{cm}^3}{\text{min} \cdot \text{kW}}$
		BS	EN	AFNOR	UNI	SS	UNE	JIS	AISI/SAE	GOST	
1700	0,24	4360-50 B	EN43B	E 36-3; E 36-4 Y3 42	Fe 510 B; C; D C45	2132 1672	F.114	SM 50 YA S45C	1045	17 GS	24
	0,24	230 M 07	1A	S 250	CF 9 SMn 28	1912	F.2111	SUM 22	1213		22
	0,24	080 M46		XC 45	C 45	1672	C45K	S 45 C	1045	45	20
	0,24	708 M 40 735 A 50	19A 47	42 CD 4 50 CV4	42 CrMo 4 51 CrV 4	2244 2230	42CrMo4 50CrV4	SCM 440 (H) SUP 10	4242; 4140 6150	G 41400 50ChGFA	18
	0,24										18
	0,24	S27 M 17		16 MC 4	16 MnCr 5	2511	16MnCr5	SCR 415	5115	18ChG	18
	0,24	410 S 21 441S29	56A	Z 12 C 13 Z 12 CF17	X 12 Cr 13 X 10 CrS 17	2302 2383	F.3401 F.3117	SUS 410 SUS 430 F	410; CA-15 430 F	12Ch13	16
	0,24	708 M 40	19A	42 CD 4	42 CrMo 4	2244	42CrMo4	SCM 440 (H)	4242; 4140	G 41400	16
	0,24										16
2000		BH13		Z40CFV5	X40CrMoV511KU	2242	F.5318	SKD61	H13		
2000	0,24	BH11		Z38CDV5	X37CrMoV51KU	X37CrMoV5-1	F.5317	SKD6	H11	4Ch5MFS	14
2000		BD2		Z160CDV12	X155CrVMo121KU	2310	F.5211	SKD11	D2		
2000		BD3		Z200Cr12	X210Cr13KU	2710	F.5212	SKD1	D3		
2000		P20		40CMD8	35CrMo8KU	2541	F.5263	SKT3	P20		
1900		P20+S		40CMD8+S			X210CrW12	SKT3+S	P20+S		
2000				Z35CD17	X38CrMo161KU		F.5267	SUS42J2+Mo	422		
1900		P20+Ni		40CMND8		2541		SKT3+Ni	P20+Ni		
1900	0,2	304 S 15 416 S 11 320S31	58E 58	Z 6 CN 18.09 Z 2 CND 17.12 Z 6 CNT 17.12	X 5 CrNi 18 10 X 2 CrNiMo 17 12 X6CrNiTi811	2332; 2333 2348 2350	F.314 F3535-X6CrNiMo- Ti17122	SUS 304 SUS 316 L SUS 347	304; 304 H 316 L 316 Ti	08Ch18N10 10Ch17N13M2T	18
2000	0,2			Z2NKD18-09 Z 7 CNU 17-04 Z8CNA17-07	NiCrMo X2CrNiMo1712 (1.4568)			SCS 24; SUS 630	630 17-7PH		18
1225	0,25	Grade 260		FT25D	G25	125	FG25	FC250	No35B		30
	0,22										22
1100	0,28	SNG 600/3 SNG 700/2	FGS 700-2	FGS 600-3 FGS 700-2	GS 600-3 GS 700-2	07 32-03 07 37-01	FGE 60-2 FGS 70-2	FCD600 FCD700	80-55-06 100-70-03		24
1050	0,28	P 510/4		MP50-5	GMN55	08 54					24
500	0,25	LM 6		A-S13	4514	4261	L-2520	AC3A	A413.0		55
	0,25	A-G3C A-Z5GU		NS DTD5074					5754 7075		60
	0,2	CZ122		CuZn39Pb2	P-CuZn3940Pb2				C37700		35
	0,2										50
	0,15	AB2		CuAl11Ni5Fe	G-CuAl1 1Fe4Ni4				B-148-52		70
	0,15								Phenolic		35
											90
1450	0,23	TA10-13 TA28		T-A6V			Ti-P63		AMSR5640 4911		20
1450	0,23										16
	0,23										18
	0,23	HR 8		NC 19 FeNb	Inconel 718				N07718		15
2900	0,22										
3100											
3300											

Vergleichstabelle: Härte
Comparison chart: hardness

Zugfestigkeit R _m Tensile strength R _m N/mm ²	Vickers- härte Vickers hardness HV	Brinell- härte Brinell hardness HB	Rockwell- härte Rockwell hardness HRC
255	80	76	
270	85	80,7	
285	90	85,5	
305	95	90,2	
320	100	95	
335	105	99,8	
350	110	105	
370	115	109	
385	120	114	
400	125	119	
415	130	124	
430	135	128	
450	140	133	
465	145	138	
480	150	143	
495	155	147	
510	160	152	
530	165	156	
545	170	162	
560	175	166	
575	180	171	
595	185	176	
610	190	181	
625	195	185	
640	200	190	
660	205	195	
675	210	199	
690	215	204	
705	220	209	
720	225	214	
740	230	219	
755	235	223	
770	240	228	20,3
785	245	233	21,3
800	250	238	22,2
820	255	242	23,1
835	260	247	24
850	265	252	24,8
865	270	257	25,6
880	275	261	26,4
900	280	266	27,1
915	285	271	27,8
930	290	276	28,5
950	295	280	29,2
965	300	285	29,8
995	310	295	31
1030	320	304	32,2
1060	330	314	33,3
1095	340	323	34,4

Zugfestigkeit R _m Tensile strength R _m N/mm ²	Vickers- härte Vickers hardness HV	Brinell- härte Brinell hardness HB	Rockwell- härte Rockwell hardness HRC
1125	350	333	35,5
1155	360	342	36,6
1190	370	352	37,7
1220	380	361	38,8
1255	390	371	39,8
1290	400	380	40,8
1320	410	390	41,8
1350	420	399	42,7
1385	430	409	43,6
1420	440	418	44,5
1455	450	428	45,3
1485	460	437	46,1
1520	470	447	46,9
1555	480	(456)	47,7
1595	490	(466)	48,4
1630	500	(475)	49,1
1665	510	(485)	49,8
1700	520	(494)	50,5
1740	530	(504)	51,1
1775	540	(513)	51,7
1810	550	(523)	52,3
1845	560	(532)	53,0
1880	570	(542)	53,6
1920	580	(551)	54,1
1955	590	(561)	54,7
1995	600	(570)	55,2
2030	610	(580)	55,7
2070	620	(589)	56,3
2105	630	(599)	56,8
2145	640	(608)	57,3
2180	650	(618)	57,8
	660		58,3
	670		58,8
	680		59,2
	690		59,7
	700		60,1
	720		61
	740		61,8
	760		62,5
	780		63,3
	800		64
	820		64,7
	840		65,3
	860		65,9
	880		66,4
	900		67
	920		67,5
	940		68

Zugfestigkeit Tensile strength	R _m	N/mm ²
Vickershärte Vickers hardness	HV	Diamantpyramide 136°, Prüfkraft F ≥ 98 N Diamond pyramid 136°, Test force F ≥ 98 N
Brinellhärte Brinell hardness Kalkuliert mit calculated from: HB = 0,95 × HV	HB	0,102 × F/D ² = 30 N/mm ² F = Prüfkraft in N, D = Kegeldurchmesser in mm F = Test force in N, D = Ball diameter in mm
Härte Rockwell C Hardness Rockwell C	HRC	Diamantkegel 120°, Gesamtprüfkraft 1471 ± 9 N Diamond cone 120°, Total test force 1471 ± 9 N

<p>a_p = Spanungstiefe in mm Depth of cut in mm</p> <p>a_e = Spanungsbreite in mm Width of cut in mm</p> <p>l = Bearbeitete Länge in mm Machined length in mm</p> <p>h_m = Mittenspanndicke in mm Mean chip thickness</p> <p>v_c = Schnittgeschwindigkeit in m/min Cutting speed in m/min</p> <p>f_z = Vorschub pro Zahn in mm Feed per tooth in mm</p> <p>d_1 = Äußerer Werkzeugdurchmesser Outside tool diameter</p> <p>S_d = Effektiver Durchmesser, Schnittkreisdurchmesser in mm Effective diameter with different inserts and at specified cut depth in mm</p> <p>d = Durchmesser der Platte in mm Insert diameter in mm</p> <p>k = Einstellwinkel Lead angle</p> <p>w_s = Eingriffswinkel Approach angle</p> <p>b_r = Zeilensprung Horizontal skip</p> <p>R_{th} = Rauhtiefe Roughness</p> <p>M_c = Spindeldrehmoment in Nm Spindle torque</p> <p>f_n = Vorschub pro Umdrehung Feed per revolution</p> <p>k_c = Spez. Schnittkraft in N/mm² Cutting force in N/mm²</p> <p>P = benötigte Maschinenleistung required machine power</p> <p>LF = Leistungsfaktor Efficiency factor</p>	Umdrehungen pro Minute n [U/min] Revolutions per minute n [rpm]	Mittlere Spanndicke h_m [mm] Mean chip thickness h_m [mm]								
	$n = \frac{v_c \cdot 1000}{\pi \cdot d_e}$	$h_m = f_z \cdot \sqrt{\frac{a_e}{d_e}}$								
	Vorschubgeschwindigkeit v_f [mm/min] Feed rate v_f [mm/min]	<p>gültig nur bis $\frac{a_e}{d_e} < 0,3$ valid only up to</p> <p>bzw. 30 % oder $w = 60^\circ$</p> <p>sonst $h_m = \frac{360 \cdot f_z \cdot a_e \cdot \sin(k)}{\pi \cdot d_e \cdot w_s}$ otherwise</p>								
	$v_f = f_z \cdot n \cdot z$									
	Vorschub pro Umdrehung f [mm/U] Feed per revolution f [mm/rev.]	Zerspanungsvolumen Q [cm³/min] Chip removal rate Q [cm³/min]								
	$f = \frac{v_f}{n}$	$Q = \frac{a_p \cdot a_e \cdot v_f}{1000}$								
	Vorschub pro Zahn f_z [mm/z] Feed per tooth f_z [mm/tooth]	Effektiver Schnittkreisdurchmesser [mm] Effective diameter of cutting								
	$f_z = \frac{V_F}{n \cdot z}$	Werkzeuge mit Eckenradius Milling cutter with corner radius								
	<p>gültig nur bis $\frac{a_e}{d_e} < 0,3$ valid only up to</p> <p>bzw. 30 % oder $w = 60^\circ$</p>	$S_d = 2 \cdot \sqrt{d_1} \cdot a_p - a_p^2$								
	<table border="1" style="width: 100%; border-collapse: collapse;"> <tr> <td style="width: 50%;">Einstellwinkel k Plunge angle</td> <td style="width: 50%;">Vorschub pro Zahn f_z Feed per tooth</td> </tr> <tr> <td style="text-align: center;">90°</td> <td style="text-align: center;">f_z</td> </tr> <tr> <td style="text-align: center;">45°</td> <td style="text-align: center;">$f_z \cdot 1,414$</td> </tr> <tr> <td style="text-align: center;">30°</td> <td style="text-align: center;">$f_z \cdot 2$</td> </tr> </table>	Einstellwinkel k Plunge angle	Vorschub pro Zahn f_z Feed per tooth	90°	f_z	45°	$f_z \cdot 1,414$	30°	$f_z \cdot 2$	Kugel-Kopierfräser Ball Nose cutter
	Einstellwinkel k Plunge angle	Vorschub pro Zahn f_z Feed per tooth								
	90°	f_z								
	45°	$f_z \cdot 1,414$								
	30°	$f_z \cdot 2$								
sonst $f_z = \frac{h_m \cdot \pi \cdot d_e \cdot w_s}{360 \cdot a_e \cdot \sin(k)}$ otherwise	$S_d = d_1 - d + 2 \cdot a_p (d - a_p)$									
Theoretische Rauhtiefe Theoretical roughness	Spindeldrehmoment Spindle torque									
$R_{th} = \frac{d_1}{2} \cdot \sqrt{\frac{d_1^2 - b_r^2}{4}}$	$M_c = \frac{f_n \cdot \pi \cdot d_1^2 \cdot k_c}{4000}$									
Zeilensprung Horizontal skip	benötigte Maschinenleistung required machine power									
$b_r = 2 \cdot \sqrt{R_{th} \cdot (d_1 - R_{th})}$	$P = \frac{Q}{LF}$									

Gültigkeit der Diagramme

für $a_p \geq 0,5 \cdot d_1$ bzw.
 $a_p \geq 0,5 \cdot d_4$ sonst

Berechnungsformeln siehe unten

Diagrams are valid

for $a_p \geq 0,5 \cdot d_1$ respectively
 $a_p \geq 0,5 \cdot d_4$ otherwise

see formula below

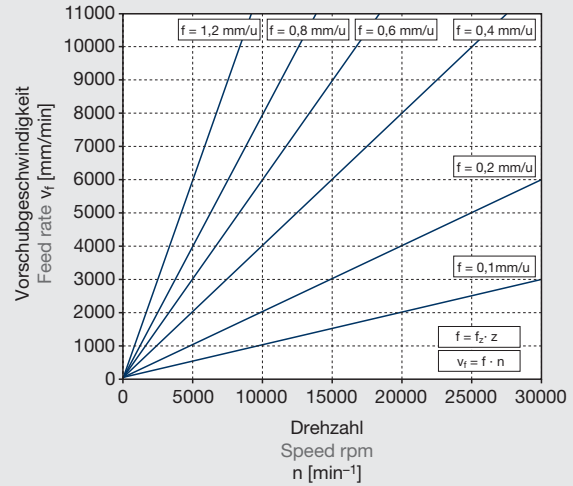
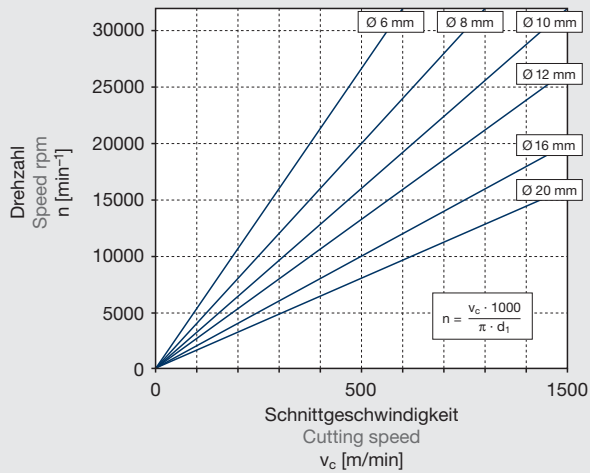

Kugel-Kopierfräser
Ball nose end mill

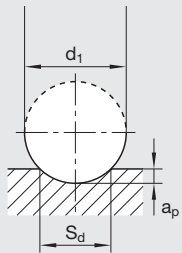

Kugel-Kopierfräser mit einer
Schnitttiefe von
Ball nose end mill with depth
of cut

$a_p < 0,5 \cdot d_1$

$$n = \frac{v_c \cdot 1000}{2 \cdot \pi \cdot \sqrt{d_1 \cdot a_p - a_p^2}} \quad [\text{min}^{-1}]$$

a_p = Schnitttiefe
Depth of cut [mm]

S_d = Schnittkreis-Ø
Cutting circle dia. [mm]

d_1 = Fräser-Ø
Milling Cutter dia. [mm]

$$S_d = 2 \cdot \sqrt{d_1 \cdot a_p - a_p^2}$$

Fräser mit Eckenradius
Milling cutter with corner radius

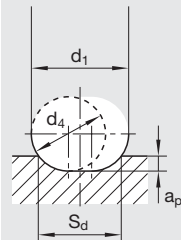

Fräser mit einer Schnitttiefe von
Cutter with depth of cut
 $a_p < 0,5 \cdot d_4$

$$n = \frac{v_c \cdot 1000}{(d_1 - d_4 + 2 \cdot \sqrt{d_4 \cdot a_p - a_p^2}) \cdot \pi} \quad [\text{min}^{-1}]$$





$d_4 = 2 \cdot \text{Eckenradius}$
 $2 \cdot \text{Corner radius}$ [mm]

$$S_d = d_1 - d_4 + 2 \cdot \sqrt{d_4 \cdot a_p - a_p^2}$$

z = Zähnezahl
No. of teeth

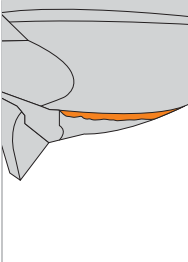
f_z = Vorschub/Zahn
Feed/Tooth [mm]

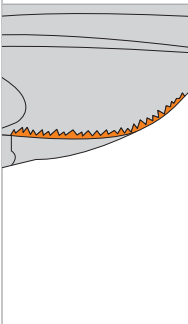
f = Vorschub/Umdrehung
Feed/Revolution [mm/u]

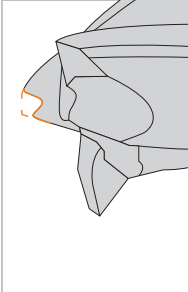
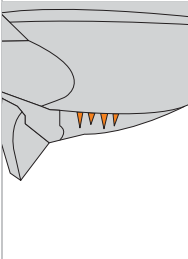
Art Type	Beschreibung Description	Maßnahmen Measures
 <p>Freiflächenverschleiß Abrieb an der Freifläche</p> <p>Flank wear Abrasion on the clearance</p>	<p>Freiflächenverschleiß entsteht durch Abrasion zwischen Werkstück und Schneidkante, also an der Freifläche.</p> <p>Flank wear is caused by abrasion between the workpiece and flank.</p>	<ul style="list-style-type: none"> ■ Schnittgeschwindigkeit verringern ■ Verschleißfesteren Schneidstoff verwenden ■ Vorschub erhöhen ■ Kühlmitteldruck erhöhen <ul style="list-style-type: none"> ■ Reduce cutting speed ■ Use more wear-resistant cutting material ■ Increase feed rate ■ Increase coolant pressure
 <p>Kolkverschleiß Aufbau an der Schneide und Auswaschung an der Spanfläche</p> <p>Crater wear Washout or build up at the rake face</p>	<p>Kolkverschleiß wird durch Diffusion und Abrasion auf der Spanfläche verursacht.</p> <p>Crater wear is caused by diffusion and abrasion of the cutting face.</p>	<ul style="list-style-type: none"> ■ Schnittgeschwindigkeit verringern ■ Härteren Schneidstoff verwenden ■ Vorschub erhöhen ■ Kühlmitteldruck erhöhen <ul style="list-style-type: none"> ■ Reduce cutting speed ■ Use harder cutting material ■ Increase feed rate ■ Increase coolant pressure
 <p>Aufbauschneide Aufklebung von Material auf der Spanfläche</p> <p>Built-up edge Adhesion of material along the cutting edge at the rake face</p>	<p>Aufgrund von Adhäsion (Anhaftung) bleiben Teile des Materials auf der Schneidkante kleben und eine Aufbauschneide bildet sich.</p> <p>Due to micro-cold welding, parts of the workpiece material adhere to the cutting edge, forming a build-up edge.</p>	<ul style="list-style-type: none"> ■ Schnittgeschwindigkeit erhöhen ■ Spanwinkel vergrößern ■ Werkzeuge mit schärferer Schneide verwenden ■ Vorschub verringern ■ Kühlmitteldruck erhöhen <ul style="list-style-type: none"> ■ Increase cutting speed ■ Increase cutting angle ■ Use tools with a sharper edge ■ Reduce feed rate ■ Increase coolant pressure
 <p>Ausbrüche Ausbrüche entlang der Schneidkante</p> <p>Chipping Chipping along the cutting edge</p>	<p>Ausbrüche entstehen aufgrund von Vibrationen, Späneschlag, Kammrisen und zu geringer Zähigkeit des Schneidstoffes.</p> <p>Chipping is caused by vibrations, impact of chips, thermal cracks and too less toughness of the carbide grade.</p>	<ul style="list-style-type: none"> ■ Schnittgeschwindigkeit verringern ■ Weniger scharfes Werkzeug verwenden ■ Zäheren Schneidstoff verwenden ■ Vorschub erhöhen ■ Kühlmitteldruck erhöhen <ul style="list-style-type: none"> ■ Reduce cutting speed ■ Use less sharp tools ■ Use tougher cutting material ■ Increase feed rate ■ Increase coolant pressure
 <p>Plastische Deformation Deformation an der Schneidkante (oft am Eckenradius)</p> <p>Plastic deformation Deformation on the cutting edge (especially at the corner radius)</p>	<p>Plastische Deformation wird durch hohe Wärmeeinwirkung in Kombination mit mechanischer Wechselbelastung verursacht.</p> <p>Plastic deformation is caused by excessive heat combined with mechanical stress.</p>	<ul style="list-style-type: none"> ■ Vorschub verringern ■ Verschleißfesteren Schneidstoff verwenden ■ Weniger scharfes Werkzeug verwenden ■ Kühlmitteldruck erhöhen <ul style="list-style-type: none"> ■ Reduce feed rate ■ Use more wear-resistant cutting material ■ Use less sharp tools ■ Increase coolant pressure
 <p>Kammrisse Gleichmäßige Risse im Werkzeug 90° zur Schneidkante</p> <p>Thermal cracks Uniform cracks in the tool orthogonal to the cutting edge</p>	<p>Kammrisse (Thermoschock) werden durch zu hohe thermische Wechsel verursacht.</p> <p>Thermal cracks are caused by thermal alternating stress (Thermal shock)</p>	<ul style="list-style-type: none"> ■ Schnittgeschwindigkeit verringern ■ Vorschub verringern ■ Kühlmitteldruck verringern <ul style="list-style-type: none"> ■ Reduce cutting speed ■ Reduce feed rate ■ Reduce coolant pressure

Fräsen mit Schaftfräsern
Milling with end mills

- 1 Abmessung nach
Dimension according
- 2 Ausführung Schneidkante
Cutting edge design
- 3 Drallwinkel
Helix angle
- 4 Toleranzklasse
Tolerance
- 5 Anwendung
Application

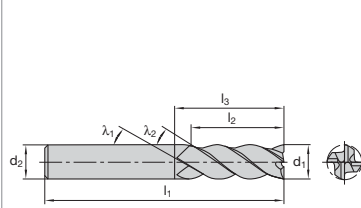
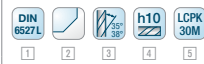

Fräsen mit Schaftfräsern
Milling with end mills

- 1 Abmessung nach
Dimension according
- 2 Ausführung Schneidkante
Cutting edge design
- 3 Drallwinkel
Helix angle
- 4 Toleranzklasse
Tolerance
- 5 Anwendung
Application
- 6 Schneidendurchmesser
Cutting edge diameter
- 7 Schaftdurchmesser
Shank diameter
- 8 Halsdurchmesser
Neck diameter
- 9 Gesamtlänge
Total length
- 10 Schneidenlänge
Cutting length
- 11 Nutzbare Länge
Operable length
- 12 Auskraglänge
Extension length
- 13 Eckenradius
Corner radius
- 14 Kegelwinkel
Cone angle
- 15 Zähnezahl
Number of teeth

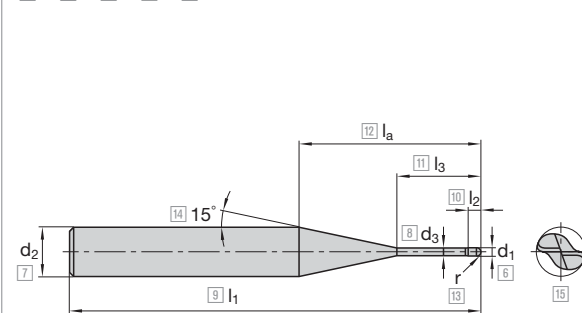
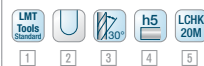

Normen für Schäfte und Schneiden
Standards for shanks and cutting edges

Kantenprofile, Drall, Drallwinkel
Edge profiles, spiral, spiral angle

entspricht Drallwinkel 10°
 corresponds with 10° spiral angle

ungleich geteilter Drall
 uneven helix angle

Besonderheiten
Special features

Zentrale Innenkühlung
 Central internal cooling

Radiale Innenkühlung
 Internal cooling radial

Trockenbearbeitung
 Dry machining

Nassbearbeitung
 Wet machining

Schneidstoffsorten
Cutting material grades

Besonderheiten
Special features

Eckenradius
 Corner radius

Kantenschutzfase
 Edge protection chamfer

Gerade
 Scarp corner

Kugel
 Ball Nose

Hochvorschub
 High Feed

Kugel mit 240°
 Ball nose with 240°

Anwendungen
Applications

Werkstoffhärte < 52 HRC
 Material hardness < 52 HRC

Werkstoffhärte < 52-70 HRC
 Material hardness < 52-70 HRC

Werkstoffhärte < 52-65 HRC
 Material hardness < 52-65 HRC

Werkstoffhärte > 60 HRC
 Material hardness > 60 HRC

Toleranzklassen
Tolerance classes

Schneidentoleranzen
 Edge tolerances

Schafttoleranzen
 Shank tolerances

Prozesse
Processes

Schruppen + Schlichten
 Roughing + Finishing

Feinstschlichten
 Superfinishing

Semischlichten + Schlichten
 Semi finishing + Finishing

Kopierfräsen
 Copying

HPC Fräser
 High Performance Cutter

Eckfräsen
 Corner milling

Trochoidalfräsen
 Trochoidal milling

Hochvorschubfräsen
 High feed milling

Mikrofräser
 Micro cutters

Schneidenlängen
Cutting length

extra kurz, kurz, lang, extra lang
 extra short, short, long, extra long

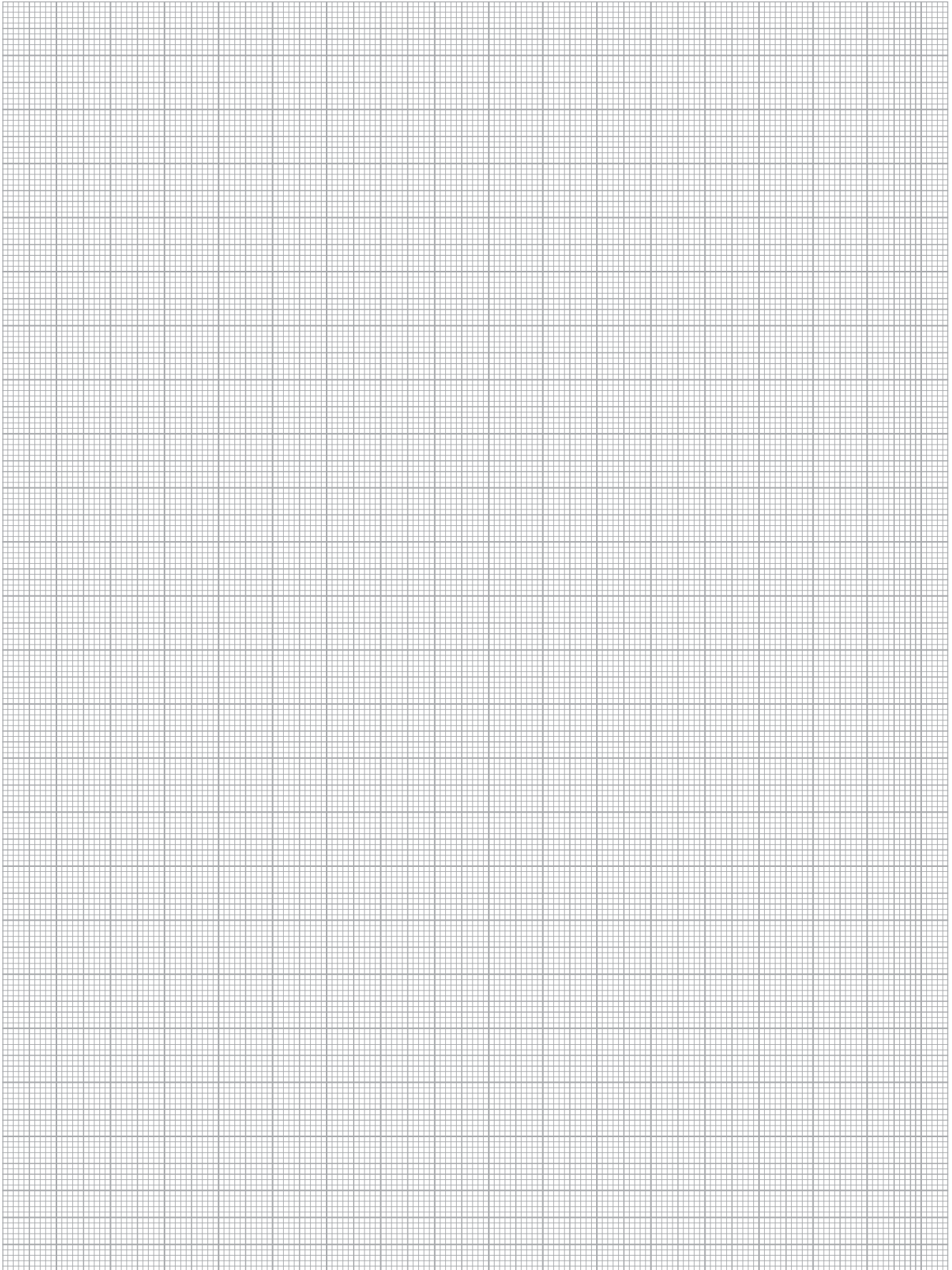

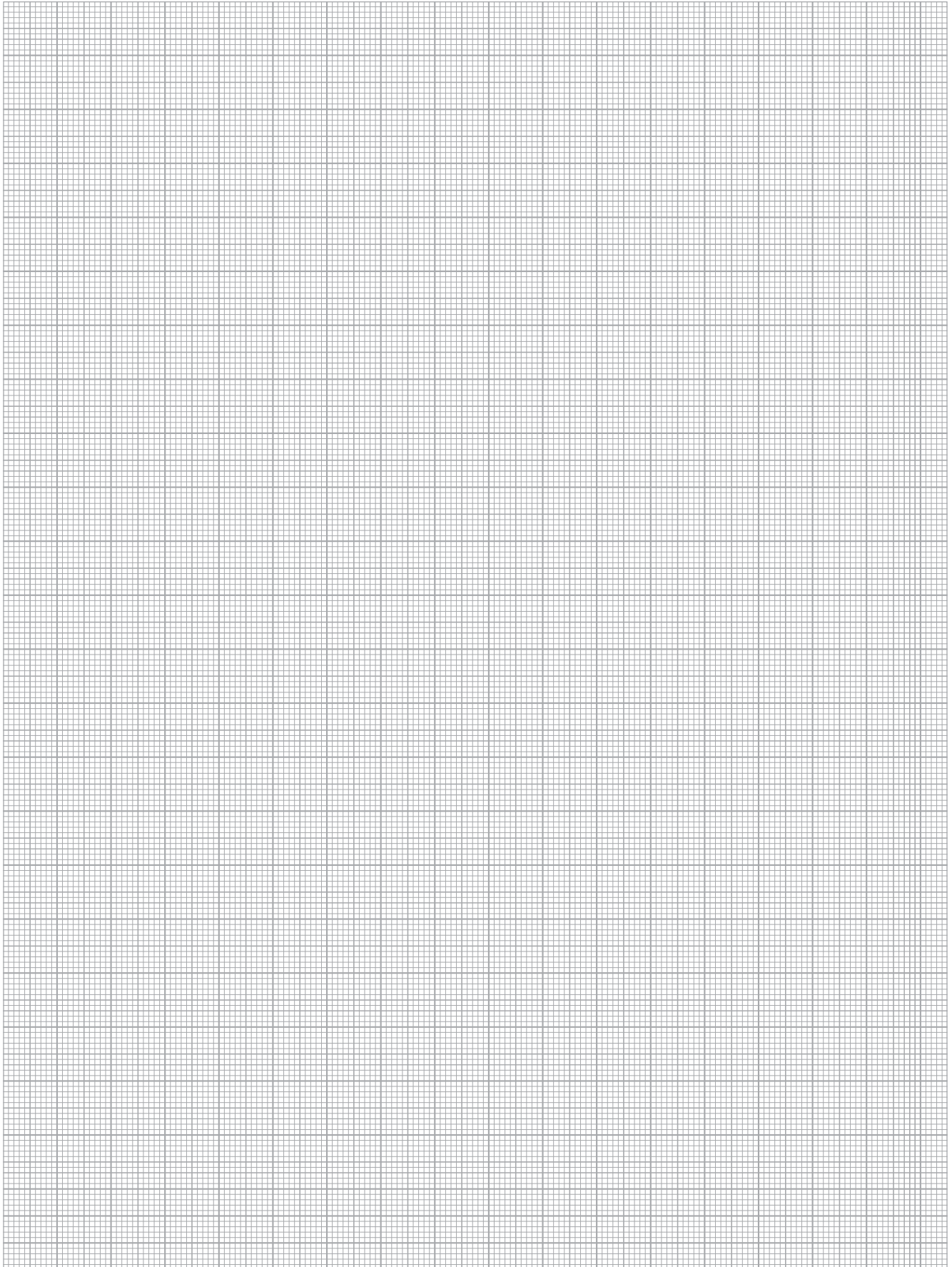

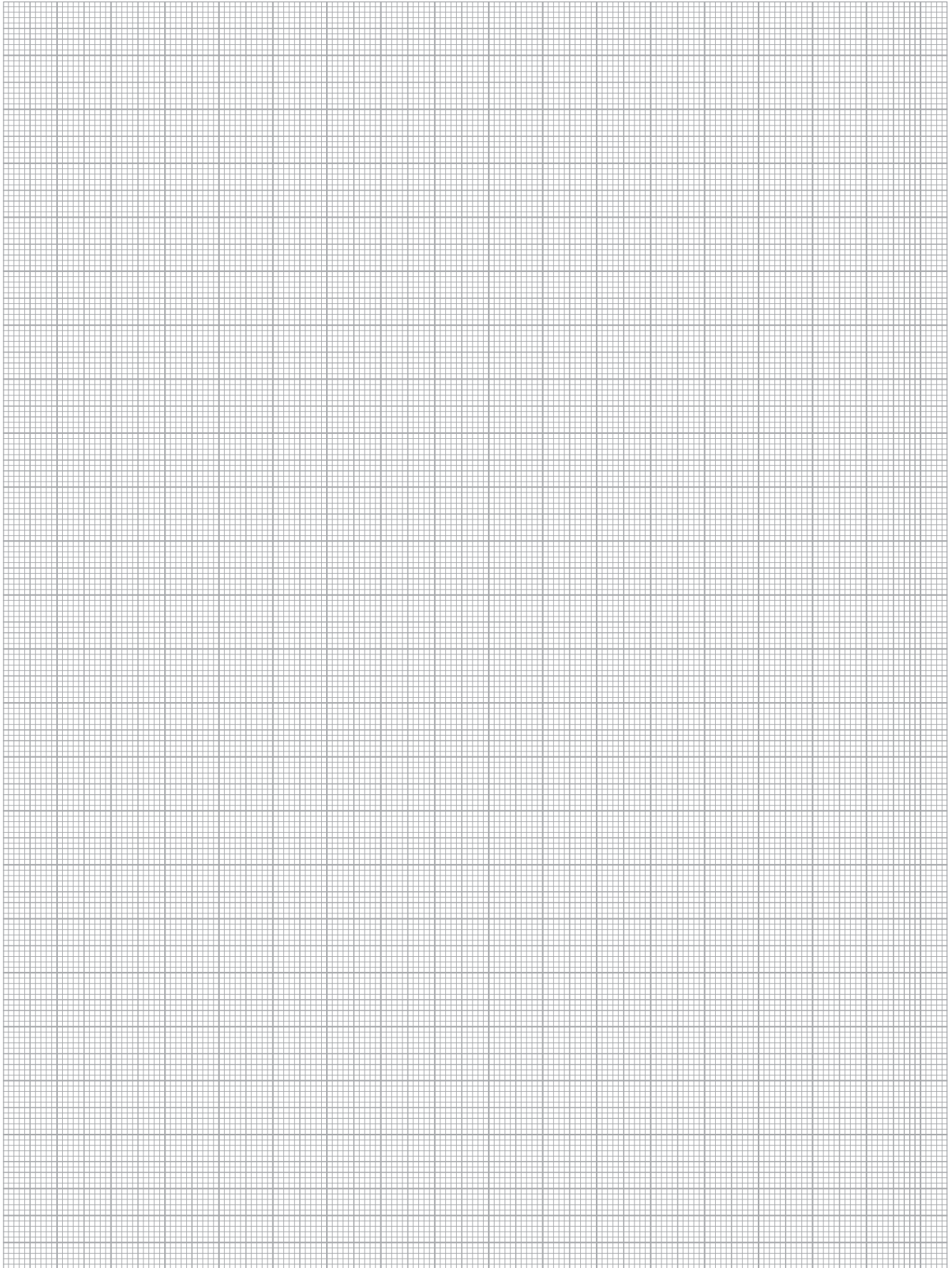

Further product catalogs and brochures about our complete tool program can be found under:
Weitere Produktkataloge und -broschüren über unser gesamtes Werkzeugprogramm finden Sie unter:

- ▶ www.lmt-tools.com/en/downloads
- ▶ www.lmt-tools.com/de/downloads

Examples
Beispiele



Indexable Milling/
Fräsen mit
Wendeschneidplatten

www.lmt-tools.com



LMT-TOOLS
BEIN
FELDEN
FACHINGER
ONSRUD



EASY.

EASYDrill
EASYReam

Die neuen Allrounder

www.lmt-tools.com



LMT-TOOLS
BEIN
FELDEN
FACHINGER
ONSRUD

We are committed to you worldwide!
Contact us and our experts.

Wir sind weltweit für Sie da!
Nehmen Sie Kontakt zu uns und
unseren Experten auf.

www.lmt-tools.com

