

LATHE CHUCKS INDEPENDENT CHUCKS

EDITION 8.3



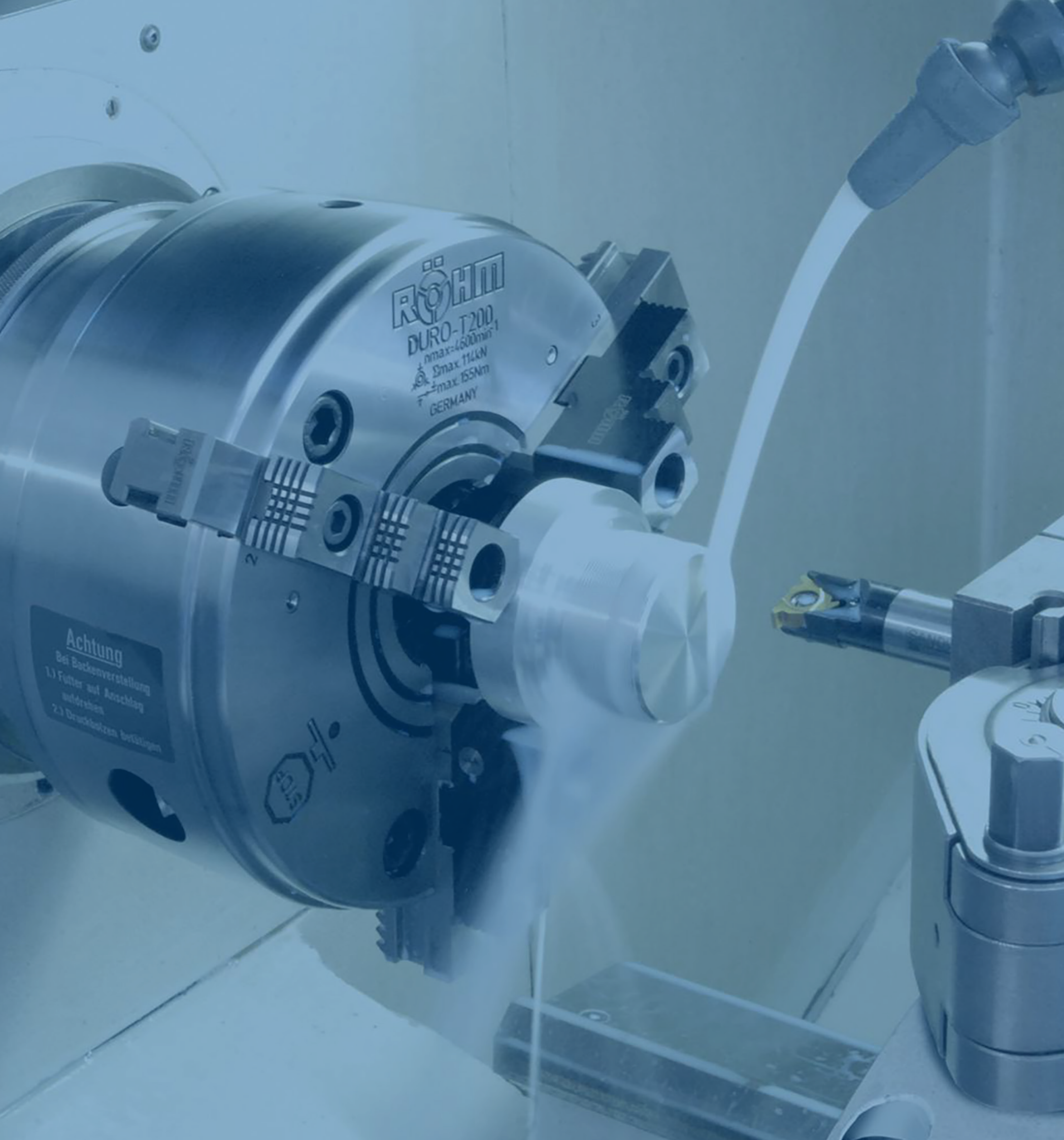

Table of contents

LATHE CHUCKS | INDEPENDENT CHUCKS

Key bar chucks with quick jaw change system

DURO-T	3009
DURO-TA	3020
DURO-TA XT	3027

Geared scroll chucks

DURO-M	3036
ZS Hi-Tru	3048
ES	3063
KRF	3068
BAV	3072
Adapter plates	3073

Independent chucks

USE - USU	3078
-----------	------

Force measurement systems

F-SENSO 2	3084
-----------	------

Zero point clamping system

EASYLOCK	3086
----------	------

Special solutions

3088



Operation guide



TYPE	DURO-T	DURO-TA	DURO-TA XT	DURO-M
	Key bar chucks with quick jaw change system			Geared scroll chucks
Chucking capacities	3 - 630 mm	3 - 646 mm	8 - 1190 mm	2 - 1224 mm
Mount	Cylindrical centre mount DIN 6350 ISO 702-3 (DIN 55027)	Cylindrical centre mount DIN 6350	Individual	Cylindrical centre mount DIN 6350 DIN 6350 BVV (mounting from front) ISO 702-1 (DIN 55026) ISO 702-2 (DIN 55029) ISO 702-3 (DIN 55027)
Through-hole	<input checked="" type="checkbox"/>			<input checked="" type="checkbox"/>
Number of jaws				
Types of jaws	 	 	 	
Workpiece	 	 	 	
Machining	 	 	 	
Rotating/Stationary	 	 	 	
Clamping				
Clamping force	■■■■■□	■■■■■□	■■■■■□	■■■■■□
Speed max.	■■■■■□	■■■■■□	■■■■■□	■■■■■□
Precision	■■■■■□	■■■■■□	■■■■■□	■■■■■□
Feature	quick jaw change system	grinding chuck with quick jaw change system	weight reduced	weight reduced and good accessibility
Page	3009	3020	3027	3036

<input checked="" type="checkbox"/> yes	3-jaw chuck	pipe	flange
	4-jaw chuck	bar	asymmetrical workpiece
		disc	

Operation guide



TYPE	ZS Hi-Tru	ES	KRF	USE - USU
	Geared scroll chucks			Independent chucks
Chucking capacities	2 - 315 mm	3 - 630 mm	2 - 200 mm	20 - 1270 mm
Mount	Cylindrical centre mount DIN 6350	Cylindrical centre mount DIN 6351	Cylindrical centre mount DIN 6350	Cylindrical centre mount ISO 702-2 (DIN 55029) ISO 702-3 (DIN 55027)
Through-hole	<input checked="" type="checkbox"/>	<input checked="" type="checkbox"/>	<input checked="" type="checkbox"/>	<input checked="" type="checkbox"/>
Number of jaws		 	 	
Types of jaws	 			
Workpiece	 	 	 	
Machining	 	 		
Rotating/Stationary	 	 		
Clamping		 		
Clamping force	■■■■■□	■■■■■□	■■■■■□	■■■■■□
Speed max.	■■■■■□	■■■■■□	■■■■■□	■■■■■□
Precision	■■■■■□	■■■■■□	■■■■■□	■■■■■□
Feature	radial precision adjustment, with special seal for grinding machines	independently adjustable jaws	keyless clamping, specially for measuring and grinding machines	independently adjustable jaws
Page	3048	3069	3074	3084

inside jaw + outside jaw	reversible jaw	rotating machining	independently adjustable jaws
base jaw	length machining	stationary machining	
base and top jaw	side machining	self-centering	

Machine spindle noses for DIN and ASA B 5.9

Machine spindle noses (not included in the scope of delivery)

ISO 702-2 (DIN 55029 and ASA B 5.9 D1)
Camlock fixing (ISO 702-2)

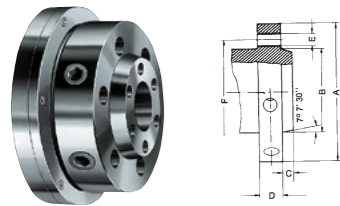

Spindle nose size	A	B	C	D	E	F
3	92,1	53,985	11,1	31,8	3x15,1	70,66
4	117,5	63,525	11,1	33,3	3x16,7	82,55
5	146	82,575	12,7	38,1	6x19,8	104,8
6	181	106,390	14,3	44,5	6x23	133,4
8	225,4	139,735	15,9	50,8	6x26,2	171,4
11	298,5	196,885	17,5	60,3	6x31	235
15	403	285,800	19	69,9	6x35,7	330,2
20	546	412,800	21	82,5	6x42,1	463,6

Latest edition of relevant DIN standard applies in each case

Typ A1-A2, B1-B2

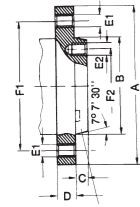

A1: Tapped holes in flange (outer bolt circle) **and** inner bolt circle. From taper size 4 with driver.

A2: Tapped holes in flange (outer bolt circle) **without** inner bolt circle.

Spindle nose size	A	B	C _{0,025}	D	Holes on outer bolt circle (F1)	Outer bolt circle	Holes on inner bolt circle (F2)	Inner bolt circle
	A	B	C _{0,025}	D	E1	F1	E2	F2

A1 (corresponds ISO 702-1)

5	133,4	82,575	14,288	22,2	11x 7/16-14 UNC	104,8	8x 7/16-14 UNC	61,9
6	165,1	106,390	15,875	25,4	11x 1/2-13 UNC	133,4	8x 1/2-13 UNC	82,6
8	209,5	139,735	17,462	28,6	11x 5/8-11 UNC	171,4	8x 5/8-11 UNC	111,1
11	279,4	196,885	19,05	34,9	11x 3/4-10 UNC	235	8x 3/4-10 UNC	165,1
15	381	285,800	20,638	41,3	12x 7/8-9 UNC	330,2	11x 7/8-9 UNC	247,6
20	520	412,800	22,225	47,6	12x 1-8 UNC	463,6	12x 1-8 UNC	368,3

Spindle nose size	A	B	C	D	Holes on outer bolt circle (F1)	Outer bolt circle
	A	B	C	D	E1	F1

A2 (corresponds ISO 702-1)

3	92,1	53,985	11,1	15,9	3x 7/16-14 UNC	70,66
4	108	63,525	11,1	19	11x 7/16-14 UNC	82,55
5	133,4	82,575	12,7	22,2	11x 7/16-14 UNC	104,8
6	165,1	106,390	14,3	25,4	11x 1/2-13 UNC	133,4
8	209,5	139,735	15,9	28,6	11x 5/8-11 UNC	171,4
11	279,4	196,885	17,5	34,9	11x 3/4-10 UNC	235
15	381	285,800	19	41,3	12x 7/8-9 UNC	330,2
20	520	412,800	20,6	47,6	12x 1-8 UNC	463,6

Spindle nose size	A	B	C _{0,025}	D	F1 G	Outer bolt circle	Holes on inner bolt circle (F2)	Inner bolt circle
	A	B	C _{0,025}	D	F1 G	F1	E2	F2

B1

5	133,4	82,575	14,288	22,2	11x11,9	104,8	8x 7/16-14 UNC	61,9
6	165,1	106,390	15,875	25,4	11x13,5	133,4	8x 1/2-13 UNC	82,6
8	209,5	139,735	17,462	28,6	11x16,7	171,4	8x 5/8-11 UNC	111,1
11	279,4	196,885	19,05	34,9	11x20,2	235	8x 3/4-10 UNC	165,1
15	381	285,800	20,638	41,3	12x23,4	330,2	11x 7/8-9 UNC	247,6
20	520	412,800	22,225	47,6	12x26,6	463,6	12x 1-8 UNC	368,3

Spindle nose size	A	B	C	D	G	Outer bolt circle
	A	B	C	D	G	F1

B2

3	92,1	53,985	11,1	15,9	3x11,9	70,66
4	108	63,525	11,1	19	11x11,9	82,55
5	133,4	82,575	12,7	22,2	11x11,9	104,8
6	165,1	106,390	14,3	25,4	11x13,5	133,4
8	209,5	139,735	15,9	28,6	11x16,7	171,4
11	279,4	196,885	17,5	34,9	11x20,2	235
15	381	285,800	19	41,3	12x23,4	330,2
20	520	412,800	20,6	47,6	12x26,6	463,6

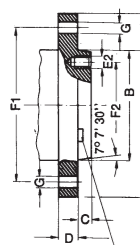

* From taper size 4 with driver

Machine spindle noses for DIN and ASA B 5.9

Machine spindle noses (not included in the scope of delivery)

DIN 800, with thread

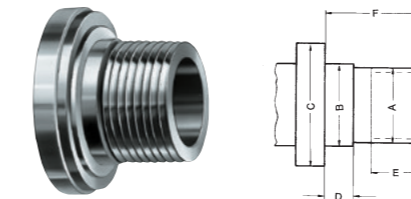

Mean tol. A	Bg5	Minimum C	D	E	F
M20	21	30	6,3	10	20
M24	25	36	8	12	24
M33	34	50	9	14	30
M39	40	56	10	16	35
M45	46	67	11	18	40
M52	55	80	12	20	45
M60	62	90	14	22	50
M76x6	78	112	16	30	63
M105x6	106	150	20	40	80

DIN 55021

From taper size 4 with driver

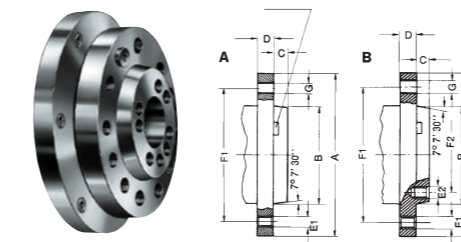

Spindle nose size	A	B	C	D	Holes on outer bolt circle (F1)	Outer bolt circle	Holes on inner bolt circle	Inner bolt circle	
	A	B	C	D	E1	G	F1	(F2) E2	F2

Form A: Tapped holes and through-holes in flange (**without** inner bolt circle)

Form B: Tapped holes and through-holes in flange (outer bolt circle) **and** tapped holes in inner bolt circle

ISO 702-1 (DIN 55026)

From taper size 4 with driver

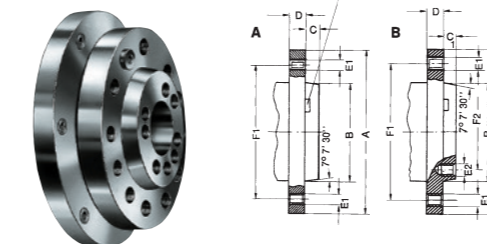

Spindle nose size	A	B	C	C ₁	D	Holes on outer bolt circle	Outer bolt circle	Holes on inner bolt circle	Inner bolt circle
	A	B	C	C ₁	D	E1	F1	(F2) E2	F2

Form A: Tapped holes in flange (outer bolt circle) **without** inner bolt circle.

Form B: Tapped holes in flange (outer bolt circle) **and** in inner bolt circle.

ISO 702-3 (DIN 55027 und 55022)

With bayonet ring fixing (ISO 702/III)

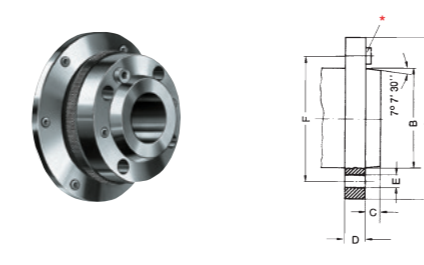

* From taper size 4 with driver

Spindle nose size	A	B	C	D	Number of holes x E	F
3	102	53,985	11	16	3x21	75
4	112	63,525	11	20	3x21	85
5	135	82,575	13	22	4x21	104,8
6	170	106,390	14	25	4x23	133,4
8	220	139,735	16	28	4x29	171,4
11	290	196,885	18	35	6x36	235
15	400	285,800	19	42	6x43	330,2
20	540	412,800	21	48	6x43	463,6

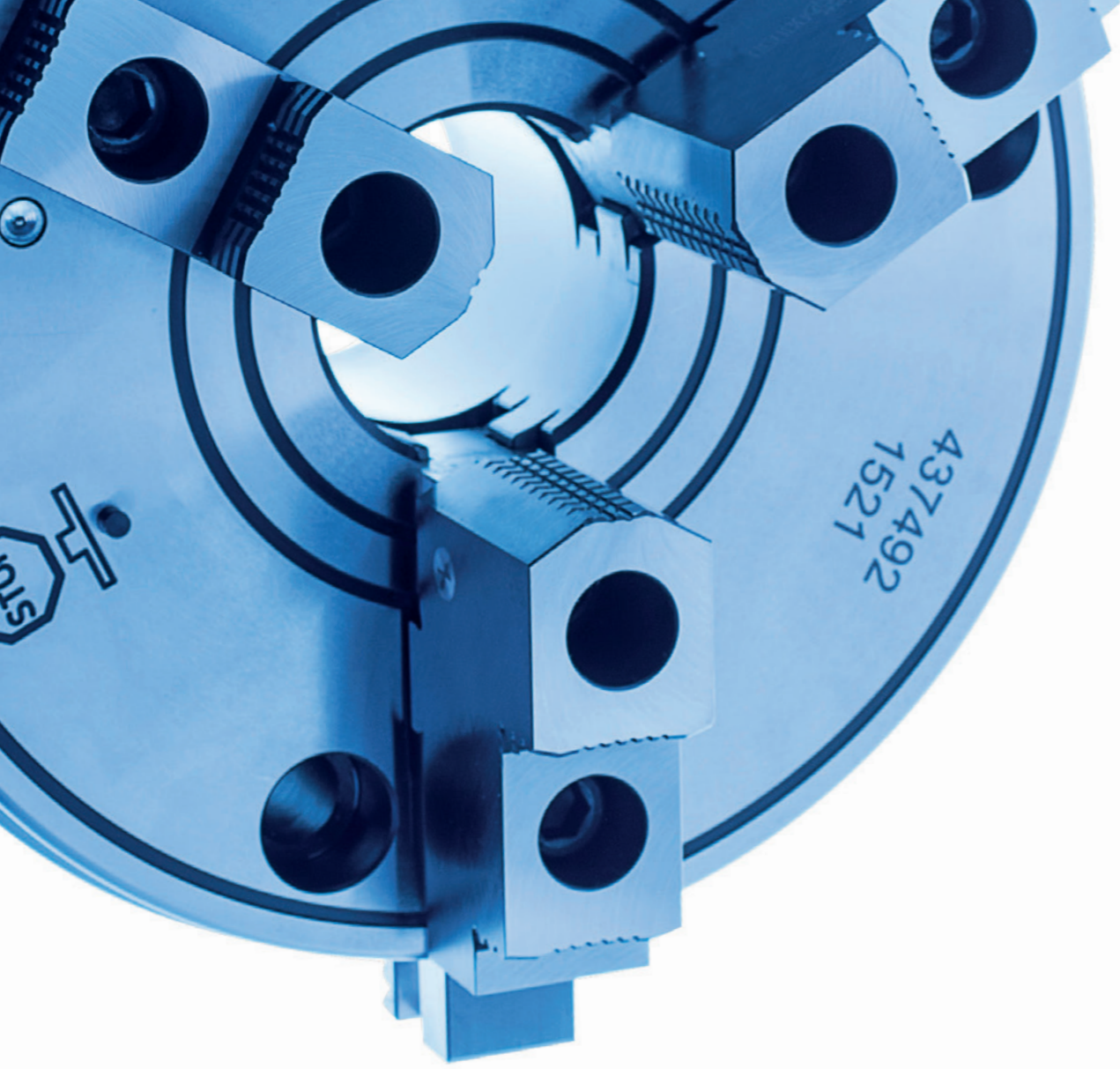

KEY BAR CHUCK WITH QUICK JAW CHANGE SYSTEM

The RÖHM key bar chucks with quick jaw change system are used successfully in areas where extremely high clamping forces, high concentricity and reliable long-term repeatability are required. Thanks to the quick jaw change system, the jaws can be quickly and easily turned, changed or offset over the entire clamping range within a few seconds.

ADVANTAGES AT A GLANCE

- ⊕ Maximum clamping forces thanks to direct force transfer via the key bar system
- ⊕ Maximum concentricity and axial run-out tolerance
- ⊕ High user-friendliness thanks to quick jaw change system

Key bar chuck with quick jaw

QUICK JAW CHANGE SYSTEM

The RÖHM key bar chucks with quick jaw change system convince in two ways. On the one hand the jaws can be quickly and easily turned, changed or offset over the entire clamping range within a few seconds. On the other the key bar chucks convince with maximum clamping forces and maximum accuracy thanks to direct force transfer via the key bar system. Large, straight surfaces transmitting the force from the key bar to the jaw teeth guarantee long life and produce a very high clamping force combined with an accuracy which is twice high as required by DIN 6386. The high clamping force is achieved without much physical effort by manually turning the key.



Video DURO-T

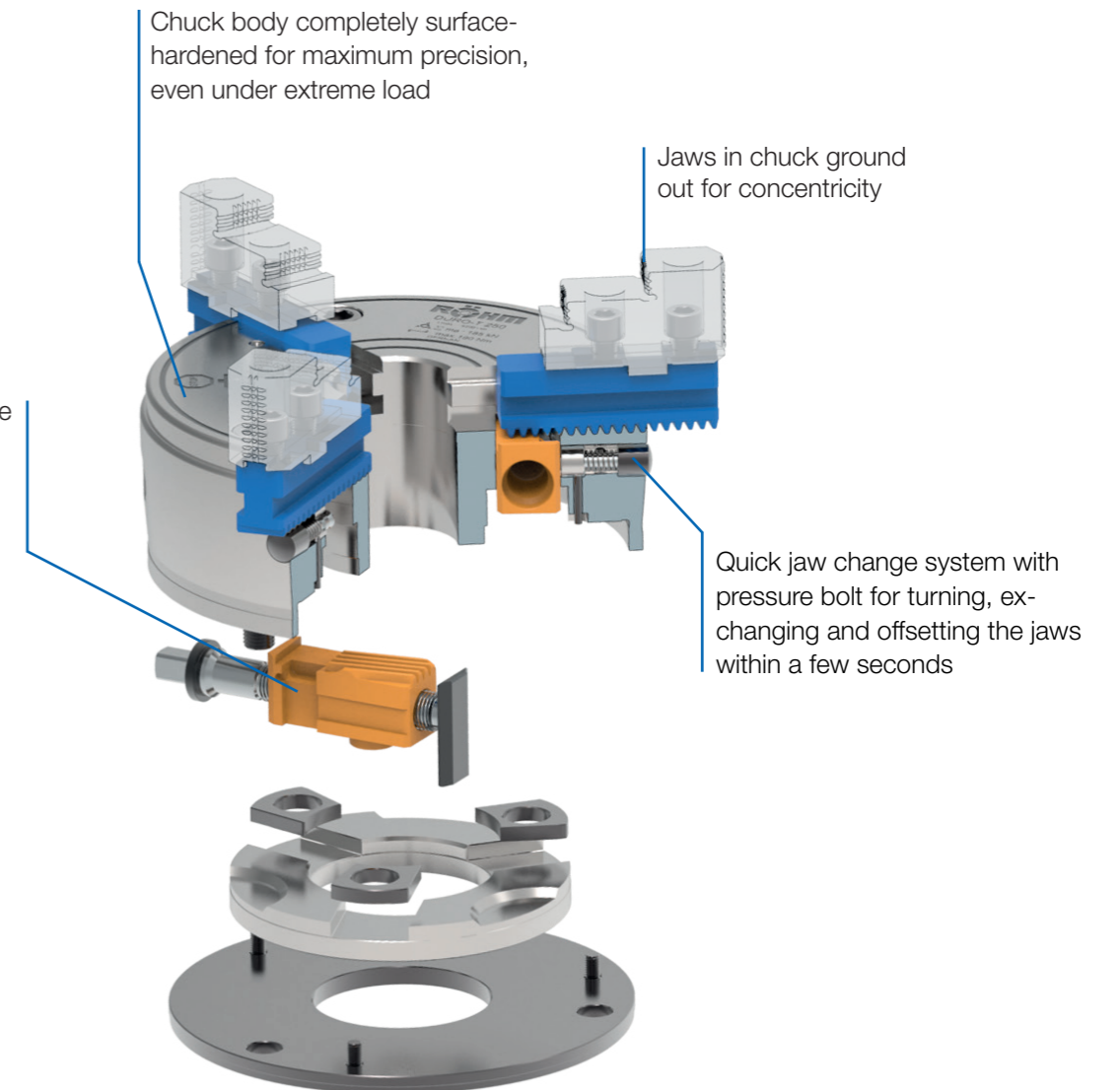

DURO-T

The DURO-T key bar chuck guarantees maximum precision, maximum clamping force and is completely balanced ex works.

Principle of operation

Thanks to the tangentially arranged threaded spindle (1), the force is transferred via a key bar (2) having an internal thread. The key bar moves the drive ring via a slide (3). Two other slides in the drive ring (4) transfer the forces to the other two key bars. The key bars having an inclined profile engage in the base jaws (5), thereby guaranteeing exact, centric clamping. The jaws can be quickly and easily turned, changed or offset over the entire clamping range within a few seconds. To do this, the key bars must be disengaged by turning the key to the left; the indicator pin (6) will project here. In this position, the jaws are secured against being hurled out in the event the machine spindle is started up unintentionally. Therefore, the gate valve (7) of each jaw must be unlocked via the corresponding pressure bolt (8) on the outer diameter of the chuck.

Large, straight-line force transfer surfaces between the key bar and jaw toothing yield a very high clamping force over a long service life and precision which is twice as high as prescribed by DIN 6386. The high clamping force is achieved without exerting any special amount of force by manually turning the key.

Lubrication

To maintain the clamping force, key bar chucks must be lubricated regularly. You will find corresponding information in the operating instructions which are enclosed with every chuck. For easy maintenance, DURO-T chucks are equipped with three additional grease nipples on the front side.

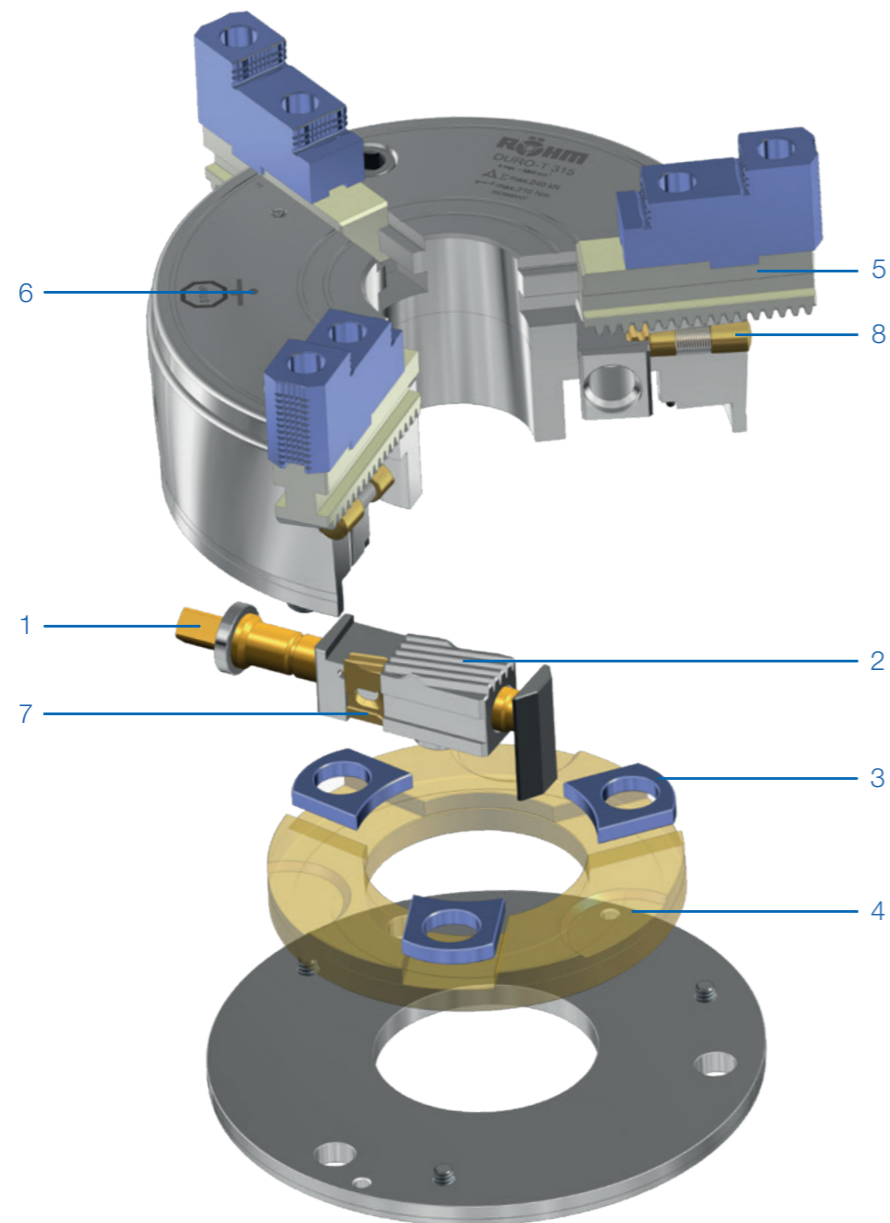

DURO-T - with quick jaw change system



APPLICATION

Optimized for turning applications, which require extremely high clamping forces, maximum concentricity, as well as reliable long-term repeatability. In combination with a base plate, stationary use on milling machines, dividing units and machining centers.

TYPE

Key bar chuck with quick jaw change system. Guaranteed maximum jaw precision as far as these are only used on the same chuck, and base and top jaws are kept screwed on for recurring work.

CUSTOMER BENEFITS

- ⊕ Maximum clamping force thanks to key bar system
- ⊕ Concentricity and axial run-out tolerance twice as exact as required in DIN precision class 1
- ⊕ Very high jaw change repeatability
- ⊕ Balanced and jaws in chuck ground out for concentricity

TECHNICAL FEATURES

- With jaw safeguard
- Chuck body completely surface-hardened
- Visual marking for quick jaw adjustment
- External shape incl. splash-water edge
- Fastening options for strongly stressed sliding surfaces
- Incl. safety key
- High corrosion protection



A08
Cylindrical centre mount

Size	Inch	Through-hole mm	With one-piece reversible jaws	With base jaws	With base jaws and reversible top jaws	D mm	F mm	Speed max. min ⁻¹	Max. Torque Nm	Max. total clamping force kN
125	5	32	437475	437482	-	46,5	100	6000	40	23
160	6 1/4	42	437476	437483	437490	63	125	5400	120	73
200	8	52	437477	437484	437491	81	160	4600	155	114
250	10	62	437478	437485	437492	92	200	4200	190	185
315	12 1/2	87	437479	437486	437493	111	250	3300	210	240
400	15 3/4	102	437480	437487	437494	118	315	2200	260	260
500	20	162	437481	437488	437495	118	400	1900	320	290
630	25	252	-	437489	437496	143	520	1100	350	320

At size 630 chuck body without convex outer contours
Further sizes and mountings available on request

A08
ISO 702-1 (DIN 55026), DIN 55021, ASA B 5.9, mounting from front

Size	Mount short taper	Through-hole mm	With one-piece reversible jaws	With base jaws	With base jaws and reversible top jaws	D mm	F mm	Speed max. min ⁻¹	Max. Torque Nm	Max. total clamping force kN
160	4	42	437570	437580	437591	76	82,62	5400	120	73
160	5	42	437571	437581	437592	79	104,8	5400	120	73
200	5	52	437572	437582	437593	93	104,8	4600	155	114
200	6	52	437573	437583	437594	97	133,4	4600	155	114
250	6	62	437574	437584	437595	108	133,4	4200	190	185
315	6	87	437575	437585	437596	124	133,4	3300	210	240
315	8	87	437576	437586	437597	130	171,4	3300	210	240
400	8	102	437577	437587	437598	135	171,4	2200	260	260
500	11	162	437578	437588	437599	138	235	1900	320	290
630	15	252	-	437590 ¹⁾	437601	167	330,2	1100	350	320

¹⁾ By conserving the precision
At size 630 chuck body without convex outer contours
Further sizes and mountings available on request

DURO-T - with quick jaw change system

A08
ISO 702-3 (DIN 55027), with studs and locknuts

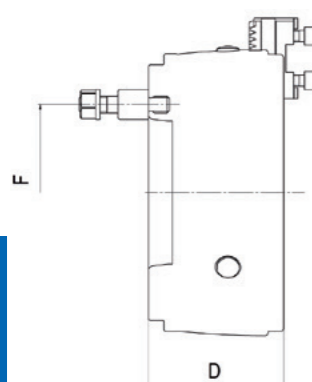

Size	Mount short taper	Through-hole mm	With one-piece reversible jaws	With base jaws	With base jaws and reversible top jaws	D mm	F mm	Speed max. min ⁻¹	Max. Torque Nm	Max. total clamping force kN
125	5	32	437499	437523	-	67	104,8	6000	40	23
160	5	42	437501	437525	437548	78	104,8	5400	120	73
160	6	42	437502	437526	437549	85	133,4	5400	120	73
200	5	52	437504	437528	437551	96	104,8	4600	155	114
200	6	52	437505	437529	437552	97	133,4	4600	155	114
250	6	62	437509	437533	437556	108	133,4	4200	190	185
250	8	62	437510	437534	437557	110	171,4	4200	190	185
315	8	87	437512	437536	437559	129	171,4	3300	210	240
315	11	87	437513	437537	437560	131	235	3300	210	240
400	8	102	437515	437539	437562	138	171,4	2200	260	260
400	11	102	437516	437540	437563	138	235	2200	260	260
500	11	162	437519	437543	437566	156	235	1900	320	290
500	15	162	437520	437544	437567	163	330,2	1900	320	290
630	11	192	-	437545 ¹⁾	437568	165	235	1100	350	320
630	15	252	-	437546 ¹⁾	437569	167	330,2	1100	350	320

¹⁾ By conserving the precision
At size 630 chuck body without convex outer contours
Further mountings available on request.

A08
ISO 702-2 (DIN 55029), stud for Camlock

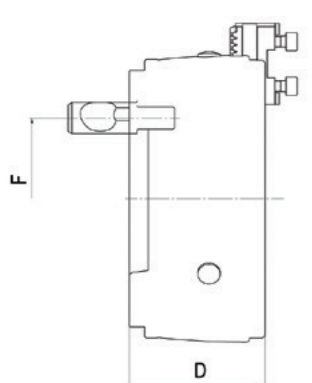

Size	Mount short taper	Through-hole mm	With one-piece reversible jaws	With base jaws	With base jaws and reversible top jaws	D mm	F mm	Speed max. min ⁻¹	Max. Torque Nm	Max. total clamping force kN
125	3	32	437602	437625	-	67	70,66	6000	40	23
125	4	32	437603	437626	-	68	82,6	6000	40	23
160	4	42	437604	437627	437650	83,5	82,6	5400	120	73
160	5	42	437605	437628	437651	87	104,8	5400	120	73
160	6	42	437606	437629	437652	104	133,4	5400	120	73
200	4	52	437607	437630	437653	97,5	82,6	4600	155	114
200	5	52	437608	437631	437654	101	104,8	4600	155	114
200	6	52	437609	437632	437655	106	133,4	4600	155	114
200	8	52	437610	437633	437656	125	171,4	4600	155	114
250	4	60	437611	437634	437657	118,5	82,6	4200	190	185
250	5	62	437612	437635	437658	112	104,8	4200	190	185
250	6	62	437613	437636	437659	117	133,4	4200	190	185
250	8	62	437614	437637	437660	120	171,4	4200	190	185
315	6	87	437615	437638	437661	145	133,4	3300	210	240
315	8	87	437616	437639	437662	136	171,4	3300	210	240
315	11	87	437617	437640	437663	143	235	3300	210	240
400	6	102	437618	437641	437664	153	133,4	2200	260	260
400	8	102	437619	437642	437665	141	171,4	2200	260	260
400	11	102	437620	437643	437666	148	235	2200	260	260
400	15	102	437621	437644	437667	168	330,2	2200	260	260
500	8	135	437622	437645	437668	143	171,4	1900	320	290
500	11	162	437623	437646	437669	148	235	1900	320	290
500	15	162	437624	437647	437670	153	330,2	1900	320	290
630	11	192	-	437648 ¹⁾	437671	170	235	1100	350	320
630	15	252	-	437649 ¹⁾	437672	175	330,2	1100	350	320

¹⁾ By conserving the precision
At size 630 chuck body without convex outer contours

Jaws DURO-T

A28
One-piece jaw EB, 3-jaw set, diagonally toothing, hardened



Item no.	Chuck Size	Number of jaws	Contents of delivery	Jaw length mm	Jaw height mm	Jaw width mm
212121	125	3	set	50	34	14
094000	160	3	set	77,7	45	20
094001	200	3	set	94,7	60	22
094002	250	3	set	114	70	26
094003	315	3	set	130	79	32
094043	400/500	3	set	167	93	45

Additionally or later applied, hardened stepped jaws must be ground out in the chuck.
For jaws which are applied later, send in the chuck.

A28
Unstepped jaw BL, 3-jaw set, diagonally toothing, unstepped, soft, material 16MnCr5



Item no.	Chuck Size	Number of jaws	Contents of delivery	Jaw length mm	Jaw height mm	Jaw width mm
304864	125	3	set	53	34	14
241699	160	3	set	84,4	45	20
249678	200	3	set	98,4	60	22
249679	250	3	set	118,7	70	26
249680	315	3	set	136,6	79	32
249681	400/500	3	set	173,6	93	45

A28
Reversible top jaw UB, 3-jaw set, hardened tongue and groove for external and internal clamping, material 16 MnCr5



Item no.	Chuck Size	Number of jaws	Contents of delivery	Jaw length mm	Jaw height mm	Jaw width mm
094012	160	3	set	61,5	32,5	20,4
094013	200	3	set	70,5	38	24,4
094014	250	3	set	92	50	34,4
094015	315	3	set	107	56	35,7
094045	400/500	3	set	130	72	50,4
140715	630	3	set	185	102	68

Additionally or later applied hardened jaws must be ground out in the chuck.
For jaws which are applied later, send in the chuck.

A28
Unstepped top jaw AB, 3-jaw set, standard design, soft, material 16 MnCr5



Item no.	Chuck Size	Number of jaws	Contents of delivery	Jaw length mm	Jaw height mm	Jaw width mm
212123	125	3	set	55	28,8	20,7
094008	160	3	set	85	36,5	20,3
094009	200	3	set	105	40	22
094010	250	3	set	125	50	30
094011	315	3	set	145	50	34,3
094046	400/500	3	set	180	73	50,5
140716	630	3	set	260	102	68

A28
Unstepped top jaw AB, 3-jaw set, extendend design, soft, material 16MnCr5



Item no.	Chuck Size	Number of jaws	Contents of delivery	Jaw length mm	Jaw height mm	Jaw width mm
137055	160	3	set	85	42,5	24,4
137056	200	3	set	105	51	34,3
137057	250	3	set	125	75	50,5
137058	315	3	set	145	74	50,5

Jaws DURO-T

A28

Base jaw GB, 3-jaw set, diagonally toothing, with mounting bolts



Item no.	Chuck Size	Number of jaws	Contents of delivery	Jaw length mm	Jaw width mm
212119	125	3	set	47	14
094004	160	3	set	74	20
094005	200	3	set	90	22
094006	250	3	set	110	26
094007	315	3	set	125	32
094044	400/500	3	set	160	45
140194	630	3	set	230	65

C 21

Reversible claw-type top jaws, standard design, tongue and groove, large clamping range, 1 piece, hardened



Item no.	Chuck Size	Jaw length mm	Jaw height mm	Jaw width mm
137060	160	66	37,5	24
137119	400/500	124	62	50
151289	630	144	78	70

C 21

Reversible claw-type top jaws, standard design, tongue and groove, small clamping range, 1 piece, hardened



Item no.	Chuck Size	Jaw length mm	Jaw height mm	Jaw width mm
137061	160	66	37,5	20
137064	200	81	43	24
137108	250	90	55	34
137114	315	100	62	34
137120	400/500	124	62	50

C 21

Reversible claw-type top jaws, standard design, tongue and groove, medium clamping range, 1 piece, hardened



Item no.	Chuck Size	Jaw length mm	Jaw height mm	Jaw width mm
137062	160	56	37,5	20
137065	200	66	43	24
137109	250	72	55	34
137115	315	86	62	34
137121	400/500	100	62	50

C 21

Reversible claw-type top jaws, large design, tongue and groove, small clamping range, 1 piece, hardened



Item no.	Chuck Size	Jaw length mm	Jaw height mm	Jaw width mm
137066	160/200	79	43	34
137110	250	80	55	50
137116	315	93	62	50

Jaws DURO-T

C 21

Reversible claw-type top jaws, large design, tongue and groove, large clamping range, 1 piece, hardened



Item no.	Chuck Size	Jaw length mm	Jaw height mm	Jaw width mm
137067	160/200	81	43	34
137111	250	90	55	50
137117	315	106	62	50

C 21

Reversible claw-type top jaws, large design, tongue and groove, medium clamping range, 1 piece, hardened



Item no.	Chuck Size	Jaw length mm	Jaw height mm	Jaw width mm
137068	160/200	66	43	34
137112	250	72	55	50
137118	315	86	62	50

C 21

Draw-down jaws, for interchangeable clamping inserts, diagonally toothing, 1 piece, without clamping inserts



Item no.	Chuck Size	Jaw length mm	Jaw height mm	Jaw width mm
141037	160	84,4	43,5	20
141039	200	98,4	47,5	22
141041	250	118,7	58,5	26
141043	315	136,4	63,9	32
141045	400/500	173,6	73,4	45

C 21

Draw-down jaws, additional clamping range, for interchangeable clamping inserts, diagonally toothing, 1 piece, without clamping inserts



Item no.	Chuck Size	Jaw length mm	Jaw height mm	Jaw width mm
141038	160	84,4	43,5	20
141040	200	98,4	47,5	22
141042	250	118,7	58,5	26
141044	315	136,4	63,9	32
141046	400	173,6	73,4	45
141048	500	173,6	73,4	45

Jaws DURO-T

C 15
Interchangeable clamping inserts, 1 piece, with claws



Item no.	Chuck Size
141049	160/200
141052	250/315
141055	400/500/630

C 15
Interchangeable clamping inserts, 1 piece, with serrated toothing



Item no.	Chuck Size
141050	160/200
141053	250/315
141056	400/500

C 15
Interchangeable clamping inserts, 1 piece, with heat treatable surface

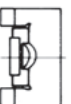

Item no.	Chuck Size
141051	160/200
141054	250/315
141057	400/500

C15
Jaw mounting bolt, piece



Item no.	Size	Thread	Contents of delivery
243893	125	M6x10	piece
200182	160/200	M8x1x22	piece
200183	250	M12x1,5x30	piece
202402	315	M12x1,5x35	piece
227618	400/500	M16x1,5x40	piece
249388	630	M20x50	piece

Accessories DURO-T

A08 Base plate with fixing slots
Complete with mounting screws and fixed T-slot nuts.
Other sizes available on request.



Item no.	Size
143163	160
143165	200
143167	250

A08 Key



Item no.	Size	Square	L mm
212124	125	8	85
094016	160	10	140
094017	200	12	160
094018	250	14	220
094019	315	17	230
094047	500	19	250
332938	630	24	410

Only for stationary used chucks

A08 Safety key



Item no.	Size	Square	L mm
242172	125	8	85
242173	160	10	140
242174	200	12	160
242175	250	14	220
242176	315	17	230
242177	500	19	250
332939	630	24	410

Corresponding with DIN 1550 for rotating chucks

A08 Torque wrench



Item no.	Torque Nm	Length mm	Output	Working accuracy
10004116	20-120	435	12,7=1/2"	3%
10004117	60-320	659	12,7=1/2"	3%

A08 Chip guard set



Item no.	Size	Contents of delivery
212122	125	set
236439	160	set
236440	200	set
236441	250	set
236442	315	set
236443	500	set

A08 Safety adapter



Item no.	Size	Square	Length mm	Mount
1333585	125	8	85	1/2"
1333587	160	10	120	1/2"
1293349	200	12	132	1/2"
1129759	250	14	186	1/2"
1129449	315	17	192	1/2"
1111583	400/500	19	220	1/2"
1162787	630	24	250	1/2"

A08 Special grease F80 for lathe chucks
for lubrication and conservation of chucking power



Item no.	Design	Contents
308555	Cartridge (DIN 1284) Ø 53.5x235mm	0,5 kg
028975	Tin	1 kg

C15 Grease gun DIN1283



Item no.	Connection	Contents of delivery
329093	M10x1	150 mm nozzle tube bent, needlepoint mouthpiece, top mouthpiece, 300 mm high pressure hose with 4 jaw hydraulics cross mouthpiece

Technical Data DURO-T

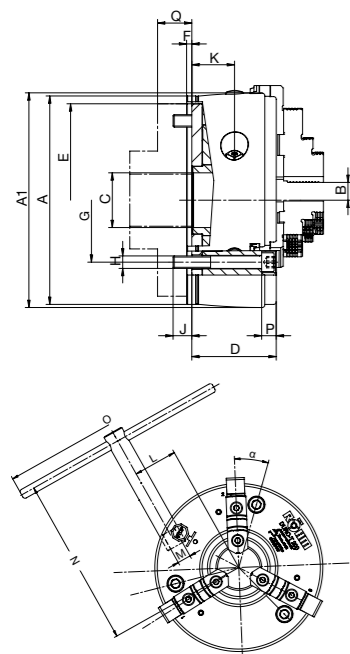

Chuck size A	125	160	200	250	315	400	500	630	
Outer diameter	A1	128	164	206	256	322	407	507	630
Jaw movement	B	4,8	6,2	6,8	8	10,2	12,5	12,5	14
Bore	C	32	42	52	62	87	102	162	252
Bore can be enlarged	C max.	35	45	55	75	102	130	180	270
	D	46,5	63	81	92	111	118	118	143
	E ^{H6}	115	145	185	235	300	380	460	580
	F	4	5	5	6	6	6	6	6
	G	100	125	160	200	250	315	400	520
	H	3xM8	3xM10	3xM12	3xM16	3xM20	3xM24	3xM24	3xM24
	J	12	15	18	25	30	37	37	37
	K	22,5	31,5	43	47	59	57,7	57,5	72
	L	32,5	42	53,5	66,5	86	110	152,5	196
	M	SW8	SW10	SW12	SW14	SW17	SW19	SW19	SW24
	N	117	182	211	284	309	359	356	570
	O	180	210	270	450	500	600	600	600
	P	8,5	13	14	17	21	25	25	29
	Q	17	30	30	35	35	40	45	55
Min. thickness of flange									
Moment of inertia GD2 ¹⁾	kgm ²	0,01	0,03	0,10	0,29	0,87	2,37	5,78	17,04
	α	21° 35'	22°	18°	19°	17°	20°	42°	69° 30'
approx. kg	kg	4,0	9,3	18,6	34,5	64	112	166	300

1) The moment of inertia was measured with base jaws but without top jaws or back plate
The bore could be enlarged (measure C, at surcharge)
■ Enlarged bore max.

Max. permissible speed

The maximum permissible speed has been fixed so that 1/3 of the gripping force is still available as residual gripping force if the maximum gripping is applied and the chuck is fitted with its heaviest jaws. The jaws may not project beyond the outside diameter of the chuck. The chuck must be in perfect condition. The specification DIN 6386 Part 1 shall be observed.

Chuck size	125	160	200	250	315	400	500	630	
Max. speed	min ⁻¹	6000	5400	4600	4200	3300	2200	1900	1100

Gripping force

The gripping force is the sum total of all jaw forces acting radially on the stationary workpiece.

The specified gripping forces are standard values.

They apply to chucks in a perfect condition which have been lubricated with RÖHM grease F79 and F80.

Chuck size	125	160	200	250	315	400	500	630	
Torque applied on key 1)	Nm	10	40	60	70	80	90	100	100
Total gripping force 1)	kN	8,5	30	48	66	80	95	102	102
Torque applied on key	Nm	40	120	155	190	210	260	320	350
Max. total gripping force	kN	23	73	114	185	240	290	320	320

1) Maintaining the accuracy

At this torque the clamping jaws have been ground at the factory; for testing the chuck must be clamped with this torque

Chuck capacities of jaw steps

Chuck size	125	160	200	250	315	400	500	630	
External chucking	A1	3-30	5-51	7-70	8-97	12-131	16-168	40-256	20-322
	A2	31-65	45-91	58-123	82-172	93-216	119-278	167-360	200-490
	A3	63-97	89-135	114-179	-	-	-	-	-
	A4	95-129	115-161	142-207	163-253	201-323	260-413	308-501	360-650
Internal chucking	J1	26-59	67-105	71-131	99-182	102-213	120-272	166-360	184-489
	J2	57-91	93-132	99-159	-	-	-	-	-
	J3	89-123	135-174	154-214	178-261	207-319	260-412	306-500	341-646

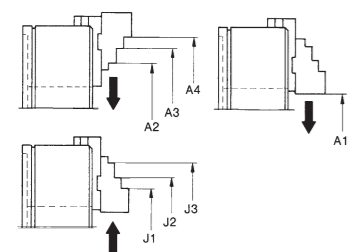

Jaw dimensions DURO-T

Reversible one-piece jaw **EB**, hardened and ground, jaw steps not ground

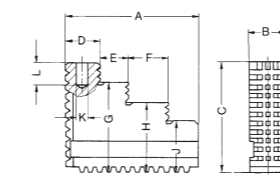

Block jaw **BL**, unstepped, soft, thread and jaw guides hardened and ground

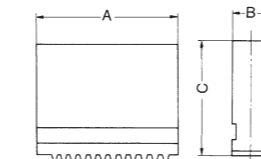

Reversible top jaw **UB**, completely hardened, cross tenon ground, jaw steps not ground

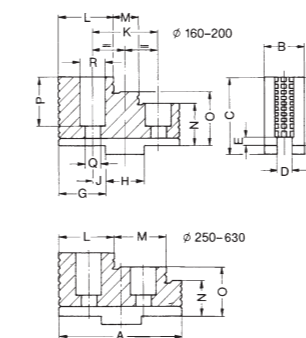

Unstepped soft top jaw **AB**, for turning out special chucking diameters

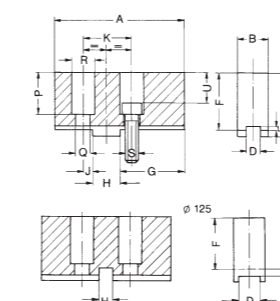

Dimensions for extendend design

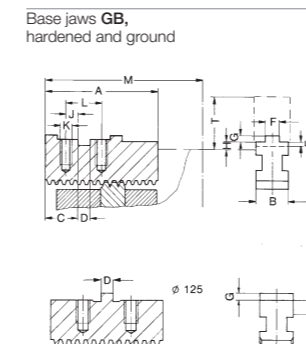

Chuck size	125	160	200	250	315	400+500
A	50	77,7	94,7	114	130	167
B	14	20	22	26	32	45
C	34	45	60	70	79	93
D	10,7	20,6	23	41,5	40,2	50,5
E	16	18,9	19,5	40,3	54	71
F	16	22	28	-	-	-
G	29	37,5	50	56	64	73
H	24	30	40	-	-	-
J	19	22,5	30	42	49	53
K	-	8	10	13	13	20
L	-	16	15	19,5	19,5	30
Jaw approx. kg	0,400	0,500	0,635	1,135	1,835	3,665

Chuck size	125	160	200	250	315	400+500
A	53	84,4	98,4	118,7	136,6	173,6
B	14	20	22	26	32	45
C	34	45	60	70	79	93
Jaw approx. kg	0,435	0,500	0,900	1,535	2,400	5

Chuck size	160	200	250	315	400+500	630
A	61,5	70,5	92	107	130	185
B	20,4	24,4	34,4	35,7	50,4	68
C	37	43	55	62	79	110
D	8	10	12	12	18	24
E	3	3,5	3,5	3,5	4,5	4,5
F	32,5	38	50	56	72	102
G	22,5	25,5	30	35,5	41,4	59
H	18	20	20	26	30	40
J	7	10	10	14	15	21
K	32	40	40	54	60	82
L	26,5	28,5	41	40	51	80
M	13	14	40,5	54	71	80
N	17,5	18	22	26	32	42
O	25	28	36	41	52	72
P	23,5	29	39	40	57	82
Q	9	9	14	14	18	22
R	15	15	20	20	26	33
T ¹⁾	38,5	45	57	63,6	80,6	114
Jaw approx. kg	0,200	0,335	0,800	1,135	2,535	6,350

1) Dimension marked on base jaw

Chuck size	125	160	200	250	315	400+500	630
A	55	85	105	125	145	180	260
B	20,7	20,3	24,4	22	30,4	50,5	68
C	31,3	41	47	45	56	80	110
D	14	8	8	10	12	12	24
E	3,3	3	3	3,5	3,5	3,5	4,5
F	28,8	36,5	42,5	40	51	75	102
G	25	42	42	50	70	74	150
H	5	18	18	20	20	26	40
J	7,5	7	7	10	10	14	21
K	20	32	32	40	40	54	82
P	24	27,5	33,5	31	42	34	58
Q	6,5	9	9	9	14	14	22
R	11	15	15	15	20	20	33
S	M6	M8x1	M8x1	M8x1	M12x1,5	M12x1,5	M12x1,5
T ¹⁾	32	42,5	48,5	47	58	57,6	71,6
U	18	19,5	25,5	23	34	27	42
Jaw approx. kg	0,200	0,435	0,600	0,735	1,400	1,500	3,700

1) Dimension marked on base jaw

Chuck size	125	160	200	250	315	400+500	630
A	47	74	90	110	125	160	230
B	14	20	22	26	32	45	65
C	21	19	23	26	30	35	52
D	5	18	20	20	26	30	40
E	-	5	5,5	5,5	6,5	7,5	9
F	-	8	10	12	12	18	24
G	2,8	2,5	3	3	3	4	4
H	3,55	6	7	7	7,6	8,6	12
J	7,5	7	10	10	14	15	21
K	M6	M8x1	M8x1	M12x1,5	M12x1,5	M16x1,5	M20
L	20	32	40	40	54	60	82
M	72	103	129	163	196	250	399
Jaw approx. kg	0,200	0,265	0,365	0,700	1,065	2,350	5,665

Chucking capacities DURO-T

Reversible claw-type top jaws KB, standard design

Reversible claw-type top jaw, large clamping range				
Chuck size	160	400	500	630
Item no.	137060	137119	137119	151289
Capacities external Ø min. - max.	142,5 - 187,5	314 - 446	311 - 534	391 - 670
Capacities internal Ø min. - max.	22,5 - 67,5	99 - 231	95 - 317	176 - 456
Interfering contour	224	528	592	800

Reversible claw-type top jaw, small clamping range						
Chuck size	160	200	250	315	400	500
Item no.	137061	137064	137108	137114	137120	137120
Capacities external Ø min. - max.	37,5 - 82,5	56 - 116	90 - 170	82 - 210	142 - 274	139 - 360
Capacities internal Ø min. - max.	133 - 178	160 - 220	177 - 257	242 - 370	301 - 433	266 - 488
Interfering contour	209	264	330	446	535	592

Reversible claw-type top jaw, medium clamping range						
Chuck size	160	200	250	315	400	500
Item no.	136062	137065	137109	137115	137121	137121
Capacities external Ø min. - max.	103 - 148	117 - 181	167 - 248	178 - 306	270 - 402	267 - 489
Capacities internal Ø min. - max.	71 - 116	91 - 155	100 - 184	97 - 225	142 - 274	139 - 361
Interfering contour	209	264	330	396	504	592

Notes

DURO-TA - sealed design



APPLICATION

Specially for grinding machines. Optimized for extremely high clamping forces, maximum concentricity, as well as reliable long-term repeatability.

TYPE

Key bar chuck with quick jaw change system. Guaranteed maximum jaw precision as far as these are only used on the same chuck, and base and top jaws are kept screwed on for recurring work.

CUSTOMER BENEFITS

- ⊕ Maximum clamping force thanks to key bar system
- ⊕ With cover for protection against dust on the face
- ⊕ Very high jaw change repeatability

TECHNICAL FEATURES

- With jaw safeguard
- Chuck body completely surface-hardened
- Visual marking for quick jaw adjustment
- External shape incl. splash-water edge
- Fastening options for strongly stressed sliding surfaces
- Incl. safety key
- High corrosion protection

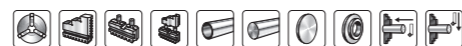

A08
Cylindrical centre mount

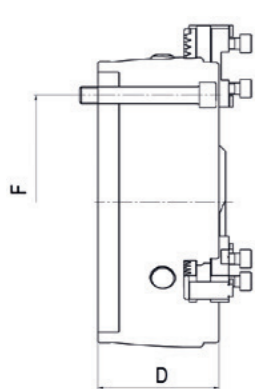

Size	Inch	With base jaws	With inside and outside jaw	D mm	Speed max. min ⁻¹	Max. Torque Nm	Max. total clamping force kN
160	6 1/4	439606	439605	63	5400	120	73
200	8	439608	439607	81	4600	155	114
250	10	439610	439609	92	4200	190	185

Further sizes and mountings available on request

Jaws DURO-TA

A28
Outside jaw DB, set, inward stepped jaw, hardened



Item no.	Chuck Size	Contents of delivery	Jaw width mm
329041	160	set	20
329042	200	set	22
329043	250	set	26

Additionally or later applied, hardened stepped jaws must be ground out in the chuck. For jaws which are applied later, send in the chuck.

A28
Inside jaw BB, set, outward stepped jaw, hardened



Item no.	Chuck Size	Contents of delivery	Jaw width mm
329038	160	set	20
329039	200	set	22
329040	250	set	26

Additionally or later applied, hardened stepped jaws must be ground out in the chuck. For jaws which are applied later, send in the chuck.

A28
Unstepped top jaw AB, 3-jaw set, soft, material 16MnCr5



Item no.	Chuck Size	Contents of delivery	Jaw length mm	Jaw height mm	Jaw width mm
329044	160	set	90	36,5	20,3
329045	200	set	100	40	22
094010	250	set	125	50	30

A28
Base jaw GB, 3-jaw set, hardened, with mounting bolts



Item no.	Chuck Size	Contents of delivery	Jaw length mm	Jaw height mm	Jaw width mm
329047	160	set	74	8	20
329048	200	set	90	10	22
329049	250	set	110	12	26

C15
Jaw mounting bolt, piece



Item no.	Size	Thread	Contents of delivery
200182	160/200	M8x1x22	piece
200183	250	M12x,5x30	piece

Accessories DURO-TA

A08 Base plate with fixing slots
Complete with mounting screws and fixed T-slot nuts.
Other sizes available on request.

Item no.	Size
143163	160
143165	200
143167	250

A08 Safety key

Item no.	Size	Square	L mm
242173	160	10	140
242174	200	12	160
242175	250	14	220

Corresponding with DIN 1550 for rotating chucks

A08 Chip guard set

Item no.	Size	Contents of delivery
236439	160	set
236440	200	set
236441	250	set

A08 Special grease F80 for lathe chucks
For lubrication and conservation of chucking power

Item no.	Design	Contents
308555	Cartridge (DIN 1284) Ø 53.5x235mm	0,5 kg
028975	Tin	1 kg

A08 Key

Item no.	Size	Square	L mm
094016	160	10	140
094017	200	12	160
094018	250	14	220

Only for stationary used chucks

A08 Torque wrench

Item no.	Torque Nm	Length mm	Output	Working accuracy
10004116	20-120	435	12,7=1/2"	3%
10004117	60-320	659	12,7=1/2"	3%

A08 Safety adapter

Item no.	Size	Square	Length mm	Mount
1333587	160	10	120	1/2"
1293349	200	12	132	1/2"
1129759	250	14	186	1/2"

C15 Grease gun DIN1283

Item no.	Connection	Contents of delivery
329093	M10x1	150 mm nozzle tube bent, needlepoint mouthpiece, top mouthpiece, 300 mm high pressure hose with 4 jaw hydraulics cross mouthpiece

Technical data DURO-TA

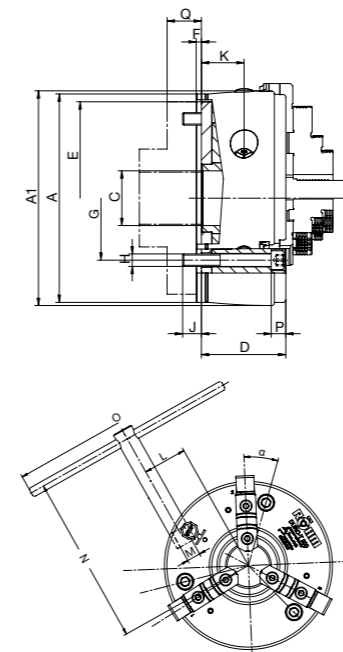

Chuck size		160	200	250
Outer diameter	A	160	206	255
Jaw movement	B	6,2	6,8	8
Bore	C	42	52	62
Bore can be enlarged	C max.	45	55	75
	D	63	81	92
	E ^{H6}	145	185	235
	F	5	5	6
	G	125	160	200
	H	3xM10	3xM12	3xM16
	J	15	18	25
	K	31,5	43	47
	L	42	53,5	66,5
	M	SW10	SW12	SW14
	N	182	211	284
	O	210	270	450
	P	13	14	17
Min. thickness of flange	Q	30	30	35
Moment of inertia ¹⁾	kgm ²	0,03	0,10	0,29
	α	22°	18°	19°
Weight approx	kg	9,5	20°	35

1) The moment of inertia was measured with base jaws but without top jaws or back plate
The bore could be enlarged (measure C, at surcharge)

Enlarged bore max.

Max. permissible speed

The maximum permissible speed has been fixed so that 1/3 of the gripping force is still available as residual gripping force if the maximum gripping is applied and the chuck is fitted with its heaviest jaws. The jaws may not project beyond the outside diameter of the chuck. The chuck must be in perfect condition. The specification DIN 6386 Part 1 shall be observed.

Chuck size		160	200	250
Max. speed	min ⁻¹	5400	4600	4200

Gripping force

The gripping force is the sum total of all jaw forces acting radially on the stationary workpiece. The specified gripping forces are standard values. They apply to chucks in a perfect condition which have been lubricated with RÖHM grease F79 and F80.

Chuck size		160	200	250
Torque applied on key in 1)	Nm	20	30	35
Total gripping force 1)	kN	15	24	33
Torque applied on key in	Nm	120	155	190
Max. total gripping force	kN	73	114	185

1) Maintaining the accuracy

Chucking capacities of jaw steps

Chuck size		160	200	250	
External chucking	Jaw position.	A1	5-51	7-70	8-97
		A2	45-91	58-123	82-172
		A3	89-135	114-179	-
		A4	115-161	142-207	163-253
Internal chucking		J1	67-105	71-131	99-182
		J2	93-132	99-159	-
		J3	135-174	154-214	178-261

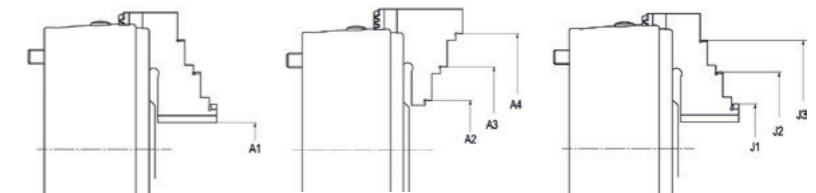
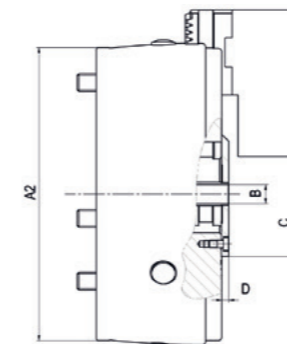

Chuck dimensions DURO-TA - Main dimensions (other dimensions on the table on the top)

Chuck size		160	200	250
Outer diameter	A	160	206	255
External chucking with BB-jaws		3-46	3-60	5-66
External chucking with DB-jaws		23-160	32-200	65-243
Internal chucking with BB jaws		28-156	32-195	47-225
Central bor for coolant	B	13	13	13
	C	70	85	92
	D	5	6	5

Jaw dimensions and chucking capacity DURO-TA

Notes

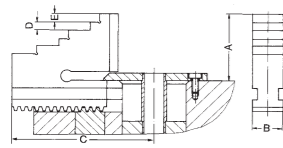

Outward stepped jaw **BB**

Chuck size	160	200	250
A	46	55	60
B	20	22	26
C max.	95	120	143,5
C min.	72	91	113
D	5	7	6
E	6	6	8
Jaw approx. kg	0,465	0,643	1,065

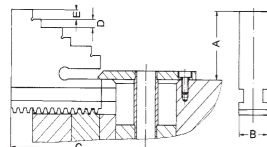

Inward stepped jaw **DB**

Chuck size	160	200	250
A	43	50	50
B	20	22	26
C max.	95	120	143,5
C min.	72	91	113
D	5	7	6
E	6	6	8
Jaw approx. kg	0,435	0,600	1,065

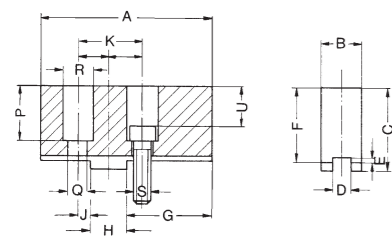

Unstepped soft top jaw **AB**

Chuck size	160	200	250
A	90	100	125
B	20,3	22	30
C	41	45	55
D	8	10	12
E	3	3,5	3,5
F	36,5	40	50
G	55	61	70
H	18	20	20
J	6	6	10
K	30	32	40
P	27,5	31	39
Q	9	9	14
R	15	15	20
S	M8x1	M8x1	M12x1,5
U	19,5	23	27
Jaw approx. kg	0,435	0,800	1,500

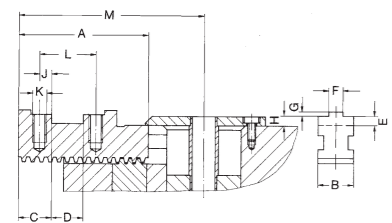

Base jaw **GB**

Chuck size	160	200	250
A	74	90	110
B	20	22	26
C	17	19	26
D	18	20	20
E	5	5,5	5,5
F	8	10	12
G	2,5	7	7
H	6	20	20
J	7	6	10
K	M8x1	M8x1	M12x1,5
L	32	32	40
M max.	105	127	148,5
M min.	91	103	125
Jaw approx. kg	0,335	0,365	0,700

Jaw dimensions and chucking capacity

Notes

DURO-TA XT

Equipped with extended and easy to assemble guideways the new lightweight DURO-TA XT is convincing with a flexible clamping area for machining large and small workpieces. Weight-reducing by up to 75 % makes maximum utilisation of the machine's potential possible.

Guideways

The new DURO-TA XT has an innovative concept for guideways that guarantees flexible and weight-reducing use. In contrast to other large chucks, the DURO-TA XT is up to 75 % lighter and that way makes maximum utilisation of the machine's potential possible and clamping of higher workpiece weights. Through the extended and easy to assemble guideways, the clamping area can be set flexibly and hence converted quickly to large and small workpieces. Through the direct mount on the base body, the guideways guarantee extremely high rigidity, stability and protection against penetration by dirt and dust.

Principle of operation

Thanks to the tangentially arranged threaded spindle, the force is transferred via a key bar having an internal thread. The key bar moves the drive ring via a slide. Two other slides in the drive ring transfer the forces to the other two key bars. The key bars having an inclined profile engage in the base jaws, thereby guaranteeing exact, centric clamping.

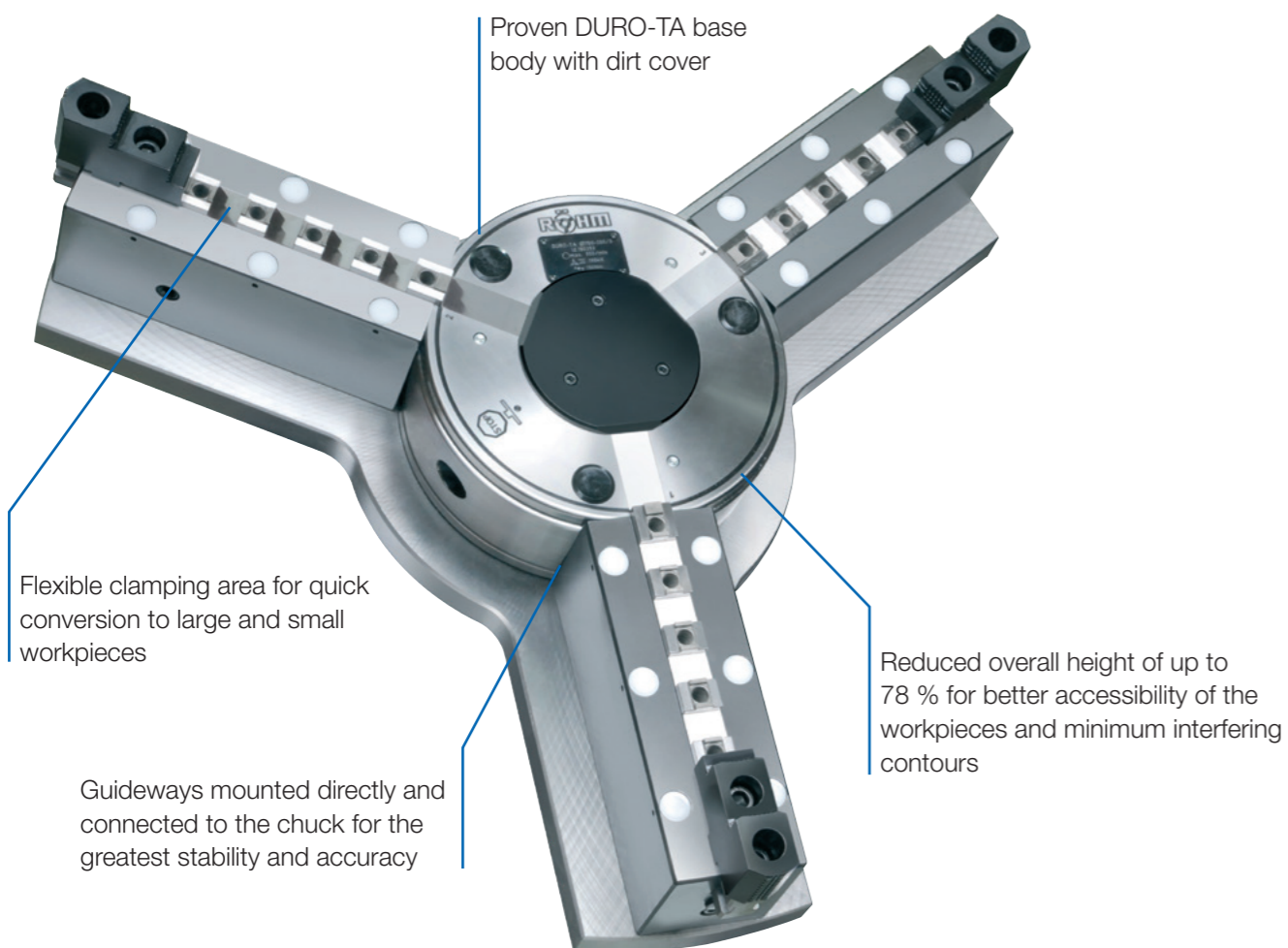

DURO-TA XT - with removable guideways



APPLICATION

On turning and milling machines.

TYPE

Key bar chuck (DURO-TA) with removable guideways.

CUSTOMER BENEFITS

- ⊕ Weight reduction by up to 75%
- ⊕ Maximum flexibility and faster retrofitting
- ⊕ Innovative design with minimum interference contour and maximum stability

TECHNICAL FEATURES

- Weight reduction by up to 75% allows maximum utilization of the machine potential and the clamping of heavier workpieces
- Flexible clamping range thanks to elongated guideways for faster conversion between large and small workpieces
- Easy dismounting of the guideways for clamping smaller workpieces
- Minimum interference contour and better workpiece accessibility thanks to compact design and a reduced design height by up to 78%
- High stability thanks to direct support of the permanently screwed guideways



full base plate

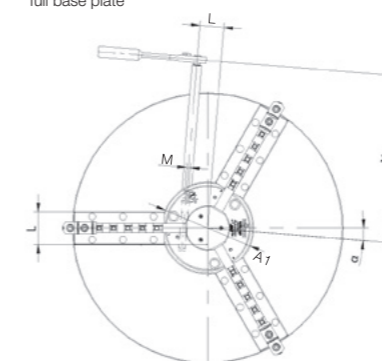

max. lightweight base plate

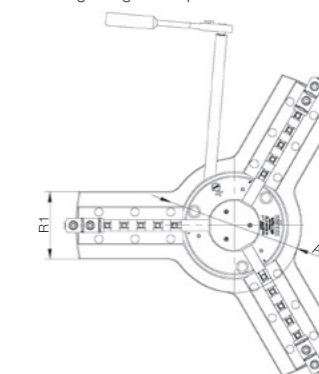

A08

DURO-TA XT key bar chuck with complete base plate

Item no.	Size	Clamping range external with extended jaws *	Clamping range external with standard jaws **	Interfering contour mm	Jaw travel mm	Weight kg	Speed max. min ⁻¹	Max. Torque Nm	Max. total clamping force kN	Weight reduction compared to a standard chuck %
180312	750 (250)	145-715	8-253	804 / 769	8	183	800	190	185	75
180313	1000 (315)	220-995	12-323	1082 / 1014	10,2	365	570	210	190	68
180314	1250 (500)	220-1190	40-501	1305	12,5	640	570	320	290	65

Customized adaptations of the base plate for further weight reduction on the machine table on request

* By dismounting of the stripping cap and use of standard reversible jaws
 ** By shortening of the base jaws. Please consider shorter clamping ranges
 Further sizes and mountings available on request

Jaws DURO-TA XT

A28
One-piece jaw EB, 3-jaw set, diagonally toothing, hardened



Item no.	Chuck Size	Number of jaws	Contents of delivery	Jaw length mm	Jaw height mm	Jaw width mm
094002	750 (250)	3	set	114	70	26
094003	1000 (315)	3	set	130	79	32
094043	1250 (500)	3	set	167	93	45

Additionally or later applied, hardened stepped jaws must be ground out in the chuck.
For jaws which are applied later, send in the chuck.
Jaws only usable in basic chuck.

A28
Unstepped jaw BL, 3-jaw set diagonally toothing, unstepped, soft, material 16MnCr5



Item no.	Chuck Size	Number of jaws	Contents of delivery	Jaw length mm	Jaw height mm	Jaw width mm
249679	750 (250)	3	set	118,7	70	26
249680	1000 (315)	3	set	136,6	79	32
249681	1250 (500)	3	set	173,6	93	45

Jaws only usable in basic chuck.

A28
Reversible top jaw UB, 3-jaw set, hardened tongue and groove for external and internal clamping, material 16 MnCr5



Item no.	Chuck Size	Number of jaws	Contents of delivery	Jaw length mm	Jaw height mm	Jaw width mm
094014	750 (250)	3	set	92	50	34,4
094015	1000 (315)	3	set	107	56	35,7
094045	1250 (500)	3	set	130	72	50,4

Additionally or later applied hardened jaws must be ground out in the chuck.
For jaws which are applied later, send in the chuck.
Jaws only usable in basic chuck.

A28
Base jaw GB, 3-jaw set, diagonally toothing, with mounting bolts



Item no.	Chuck Size	Number of jaws	Contents of delivery	Jaw length mm	Jaw width mm
094006	750 (250)	3	set	110	26
094007	1000 (315)	3	set	125	32
094044	1250 (500)	3	set	160	45

Jaws only usable in basic chuck.

C 21
Draw-down jaws, for interchangeable clamping inserts, diagonally toothing, 1 piece, without clamping inserts



Item no.	Chuck Size	Jaw length mm	Jaw height mm	Jaw width mm
141041	750 (250)	118,7	58,5	26
141043	1000 (315)	136,4	63,9	32
141045	1250 (500)	173,6	73,4	45

Jaws only usable in basic chuck.

C 21
Draw-down jaws, additional clamping range, for interchangeable clamping inserts, diagonally toothing, 1 piece, without clamping inserts

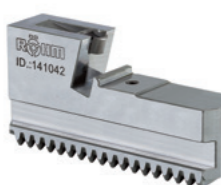

Item no.	Chuck Size	Jaw length mm	Jaw height mm	Jaw width mm
141042	750 (250)	118,7	58,5	26
141044	1000 (315)	136,4	63,9	32
141048	1250 (500)	173,6	73,4	45

Jaws only usable in basic chuck.

Jaws DURO-TA XT

C 15
Interchangeable clamping inserts, 1 piece, with claws



Item no.	Chuck Size
141052	750 (250)/1000 (315)
141055	1250 (500)

Jaws only usable in basic chuck.

C 15
Interchangeable clamping inserts, 1 piece, with serrated toothing



Item no.	Chuck Size
141053	750 (250)/1000 (315)
141056	1250 (500)

Jaws only usable in basic chuck.

C 15
Interchangeable clamping inserts, 1 piece, with heat treatable surface



Item no.	Chuck Size
141054	750 (250)/1000 (315)
141057	1250 (500)

Jaws only usable in basic chuck.

A28
Reversible top jaw UB, 3-jaw set, hardened tongue and groove for external and internal clamping, material 16 MnCr5



Item no.	Number of jaws	Contents of delivery	Jaw length mm	Jaw width mm
180410	3	set	92	34,4
180411	3	set	107	35,7
180412	3	set	130	50,4

Additionally or later applied hardened jaws must be ground out in the chuck.
For jaws which are applied later, send in the chuck.

A28
Unstepped top jaw AB, 3-jaw set, standard design, soft, material 16 MnCr5



Item no.	Chuck Size	Number of jaws	Contents of delivery	Jaw length mm	Jaw height mm	Jaw width mm
094010	750 (250)	3	set	125	50	30
094011	1000 (315)	3	set	145	50	34,3
094046	1250 (500)	3	set	180	73	50,5

C 21
Reversible claw-type top jaws, standard design, tongue and groove, large clamping range, 1 piece, hardened



Item no.	Chuck Size	Jaw length mm	Jaw height mm	Jaw width mm
137119	1250 (500)	124	62	50

Jaws DURO-TA XT

C 21

Reversible claw-type top jaws, standard design, tongue and groove, medium clamping range, 1 piece, hardened



Item no.	Chuck Size	Jaw length mm	Jaw height mm	Jaw width mm
137109	750 (250)	72	55	34
137115	1000 (315)	86	62	34
137121	1250 (500)	100	62	50

C 21

Reversible claw-type top jaws, standard design, tongue and groove, small clamping range, 1 piece, hardened



Item no.	Chuck Size	Jaw length mm	Jaw height mm	Jaw width mm
137108	750 (250)	90	55	34
137114	1000 (315)	100	62	34
137120	1250 (500)	124	62	50

C 21

Reversible claw-type top jaws, large design, tongue and groove, small clamping range, 1 piece, hardened



Item no.	Chuck Size	Jaw length mm	Jaw height mm	Jaw width mm
137110	750 (250)	80	55	50
137116	1000 (315)	93	62	50

C 21

Reversible claw-type top jaws, large design, tongue and groove, medium clamping range, 1 piece, hardened



Item no.	Chuck Size	Jaw length mm	Jaw height mm	Jaw width mm
137112	750 (250)	72	55	50
137118	1000 (315)	86	62	50

C 21

Reversible claw-type top jaws, large design, tongue and groove, large clamping range, 1 piece, hardened



Item no.	Chuck Size	Jaw length mm	Jaw height mm	Jaw width mm
137111	750 (250)	90	55	50
137117	1000 (315)	106	62	50

Accessories DURO-TA XT

C15 Special grease F80 for lathe chucks
For lubrication and conservation of chucking power



Item no.	Design	Contents
308555	Cartridge (DIN 1284) Ø 53.5x235mm	0,5 kg
028975	Tin	1 kg

C15 Torque wrench



Item no.	Torque Nm	Length mm	Output	Working accuracy
10004116	20-120	435	12,7=1/2"	3%
10004117	60-320	659	12,7=1/2"	3%

C15 Grease gun DIN1283



Item no.	Conne- ction	Contents of delivery
329093	M10x1	150 mm nozzle tube bent, needlepoint mouthpiece, top mouthpiece, 300 mm high pressure hose with 4 jaw hydraulics cross mouthpiece

A08 Safety adapter



Item no.	Size	Square	Length mm	Mount
1129759	750 (250)	14	186	1/2"
1129449	1000 (315)	17	192	1/2"
1111583	1250 (500)	19	220	1/2"

Technical data DURO-TA XT

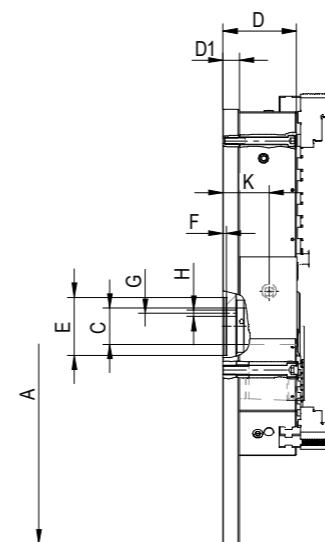

Chuck size A		750	1000	1250
Outer diameter Chuck	A1	256	322	507
Outer diameter Base plate	A2	320	400	590
Jaw movement	B	8	10,2	12,5
Bore 1)	C	62	87	162
	D	127	152	160
	D ¹	28	34	35
	EH6	100	100	100
	F	6	6	6
	G	45	45	45
	H	11	11	11
	K	79,5	98,0	97,5
	L	66,5	86	152,5
	M	SW14	SW17	SW19
	N	464	565	724
	R	90	100	130
	R1	160	180	210
	S	370	495	615
Moment of inertia GD2 2)	kgm ²	10,52	37,92	98,70
Moment of inertia GD2 2) 3)	kgm ²	5,66	18,10	48,93
α		4,6°	4,6°	4,5°
approx. kg	kg	183	365	640
approx. kg 3)	kg	127	233	436

- 1) With dirt cover
- 2) The moment of inertia was measured with base jaws but without top jaws
- 3) With max. lightweight base plate

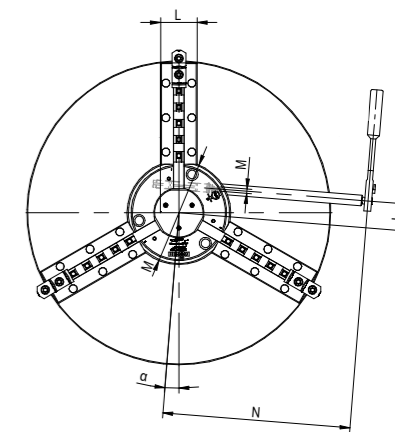

full base plate

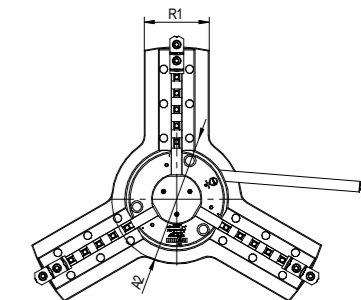

max. lightweight base plate

Max. permissible speed

The maximum permissible speed has been fixed so that 1/3 of the gripping force is still available as residual gripping force if the maximum gripping is applied and the chuck is fitted with its heaviest jaws. The jaws may not project beyond the outside diameter of the chuck. The chuck must be in perfect condition. The specification DIN 6386 Part 1 shall be observed.

Chuck size		750	1000	1250
Max. speed	min ⁻¹	800	570	450

Gripping force

The gripping force is the sum total of all jaw forces acting radially on the stationary workpiece. The specified gripping forces are standard values. They apply to chucks in a perfect condition which have been lubricated with RÖHM grease F79 and F80.

Chuck size		750	1000	1250
Torque applied on key 1)	Nm	70	80	100
Total gripping force 1)	kN	66	80	102
Torque applied on key	Nm	190	210	320
Max. total gripping force	kN	185	240	290

1) Maintaining the accuracy

At this torque the clamping jaws have been ground at the factory; for testing the chuck must be clamped with this torque

Chuck capacities of jaw steps

Chuck size		750	1000	1250	
External chucking	Jaw position	A1	144-618	215-864	215-1140
		A2	144-638	330-890	199-1159
		A3	224-719	223-995	340-1200
Internal chucking	Jaw position	J1	227-700	298-946	318-1141
		J2	307-780	404-1052	459-1282
max. interfering contour		808/**773	1086/**1018	1309	

** By shortening of the base jaws. Please consider shorter clamping ranges.

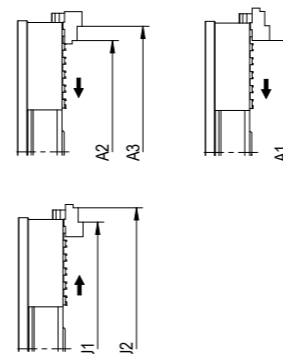

Jaw dimensions DURO-TA XT

Notes

Reversible top jaw **UB**, completely hardened, cross tenon ground, jaw steps not ground

Jaws only usable in basic chuck.

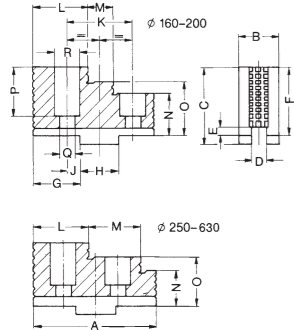

Chuck size	750	1000	1250
A	92	107	130
B	34,4	35,7	50,4
C	55	62	79
D	12	12	18
E	3,5	3,5	4,5
F	50	56	72
G	30	35,5	41,4
H	20	26	30
J	10	14	15
K	40	54	60
L	41	40	51
M	40,5	54	71
N	22	26	32
O	36	41	52
P	39	40	57
Q	14	14	18
R	20	20	26
T ¹⁾	57	63,6	80,6
Jaw approx. kg	0,800	1,135	2,535

1) Dimension marked on base jaw

Unstepped soft top jaw **AB**, for turning out special chucking diameters

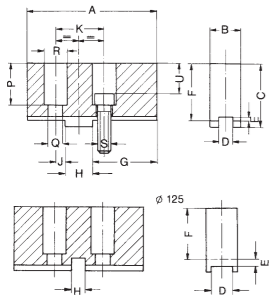

Chuck size	750	1000	1250		
A	125	125	145	145	180
B	30,4	50,5	34,3	50,5	50,5
C	55	80	56	80	80
D	12	12	12	12	18
E	3,5	3,5	3,5	3,5	4,5
F	50	75	50	74	73
G	70	70	74	74	100
H	20	20	26	26	30
J	10	10	14	14	15
K	40	40	54	54	60
P	39	54	34	48	58
Q	14	14	14	14	18
R	20	20	20	20	26
S	M12x1,5	M12x1,5	M12x1,5	M12x1,5	M16x1,5
T ¹⁾	57	72	57,6	71,6	81,6
U	27	42	22	36	42
Jaw approx. kg	1,500	3,700	2,265	4,800	4,500

1) Dimension marked on base jaw

Reversible one-piece jaw **EB**, hardened and ground, jaw steps not ground
Jaws only usable in basic chuck.

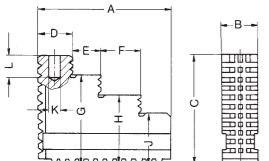

Blockbacks **BL**, ungestuft, ungehärtet, Verzahnung und Führung gehärtet und geschliffen. Jaws only usable in basic chuck.

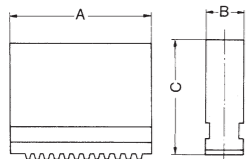

Chuck size	750	1000	1250
A	114	130	167
B	26	32	45
C	70	79	93
D	41,5	40,2	50,5
E	40,3	54	71
F	-	-	-
G	56	64	73
H	-	-	-
J	42	49	53
K	13	13	20
L	19,5	19,5	30
Jaw approx. kg	1,135	1,835	3,665

Chuck size	750	1000	1250
A	118,7	136,6	173,6
B	26	32	45
C	70	79	93
Jaw approx. kg	1,535	2,400	5

Base jaws **GB**, hardened and ground
Jaws only usable in basic chuck.

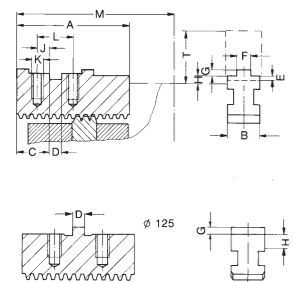

Chuck size	750	1000	1250
A	110	125	160
B	26	32	45
C	26	30	35
D	20	26	30
E	5,5	6,5	7,5
F	12	12	18
G	3	3	4
H	7	7,6	8,6
J	10	14	15
K	M12x1,5	M12x1,5	M16x1,5
L	40	54	60
M	163	196	250 294
Jaw approx. kg	0,700	1,065	2,350

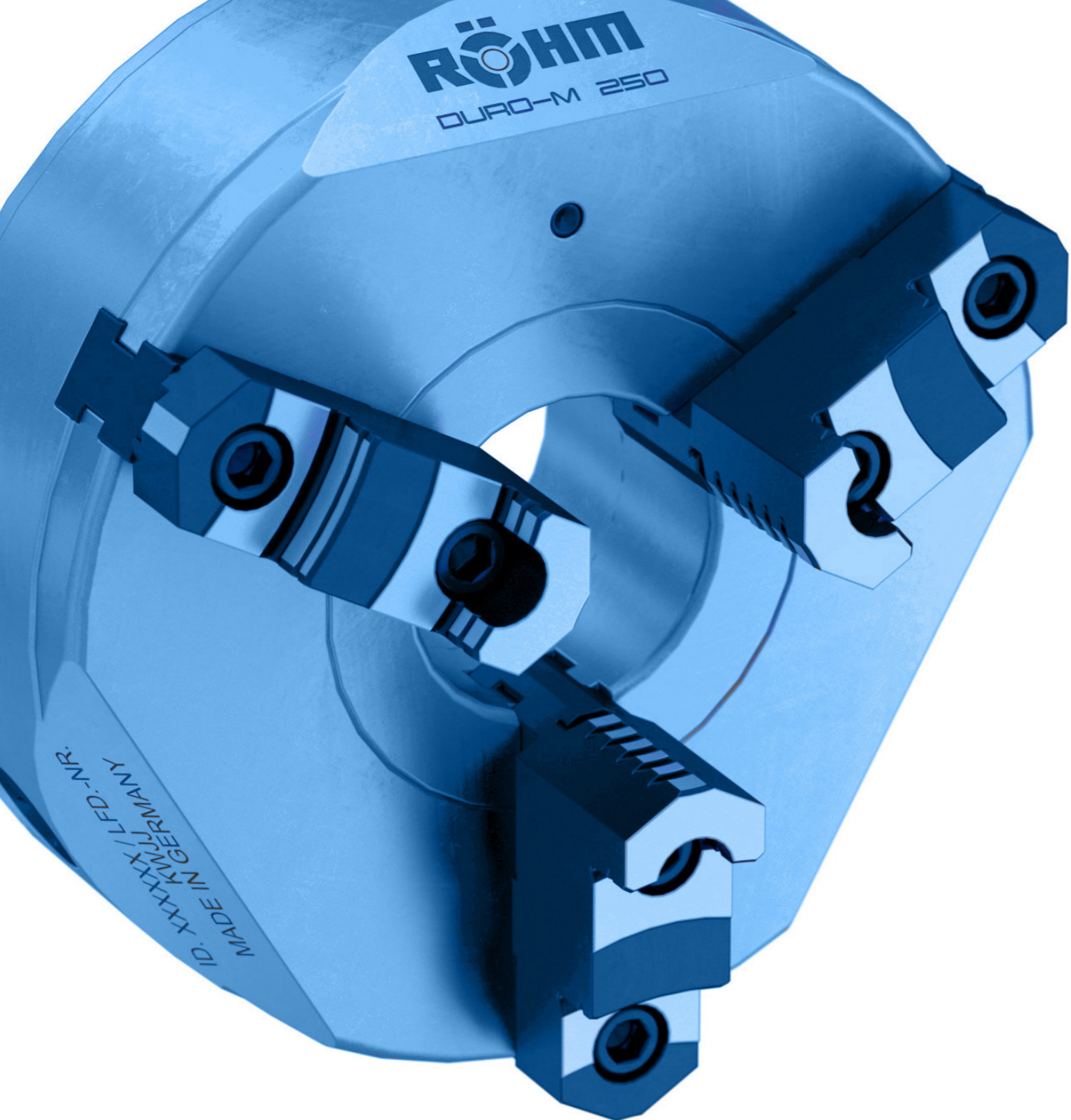

GEARED SCROLL CHUCKS

The RÖHM geared scroll chucks have proven themselves a thousand times over and have already been used successfully on lathes, rotary tables and dividing attachments for decades. The jaws can be adjusted over the entire clamping range in order to be able to very quickly clamp workpieces with a wide clamping diameter range without offsetting the jaws.

ADVANTAGE AT A GLANCE

- ⊕ Quick jaw adjustment over the entire clamping range
- ⊕ Proven chuck with optimal price/performance ratio
- ⊕ Protection of the machine spindle by means of splash-water edge

Geared scroll chucks

PROVEN CHUCK WITH SPIRAL RING

The RÖHM geared scroll chucks have already been in use for decades and have proven themselves a thousand times over. The jaws can be quickly adjusted over the entire clamping range by means of the spiral ring. Using the radially arranged drive, the force is transferred to the hardened spiral ring via a bevel gearing and further conducted to the clamping jaws via the spiral.

And we are now continuing to write this story: with the new DURO-M scroll chuck - Made in Germany. It carries the genes of its predecessors and inherits their most important properties, such as durability, precise power transmission and fast jaw adjustment over the entire clamping range.

The most significant change: the characteristic scallops. They not only look good, but also have tangible benefits such as weight reduction and good accessibility. In addition, the DURO-M impresses with optimized power transmission and high rigidity. Due to the wide range of diameters, the DURO-M can be used on all common spindle interfaces and is thus designed for long-term and durable use.

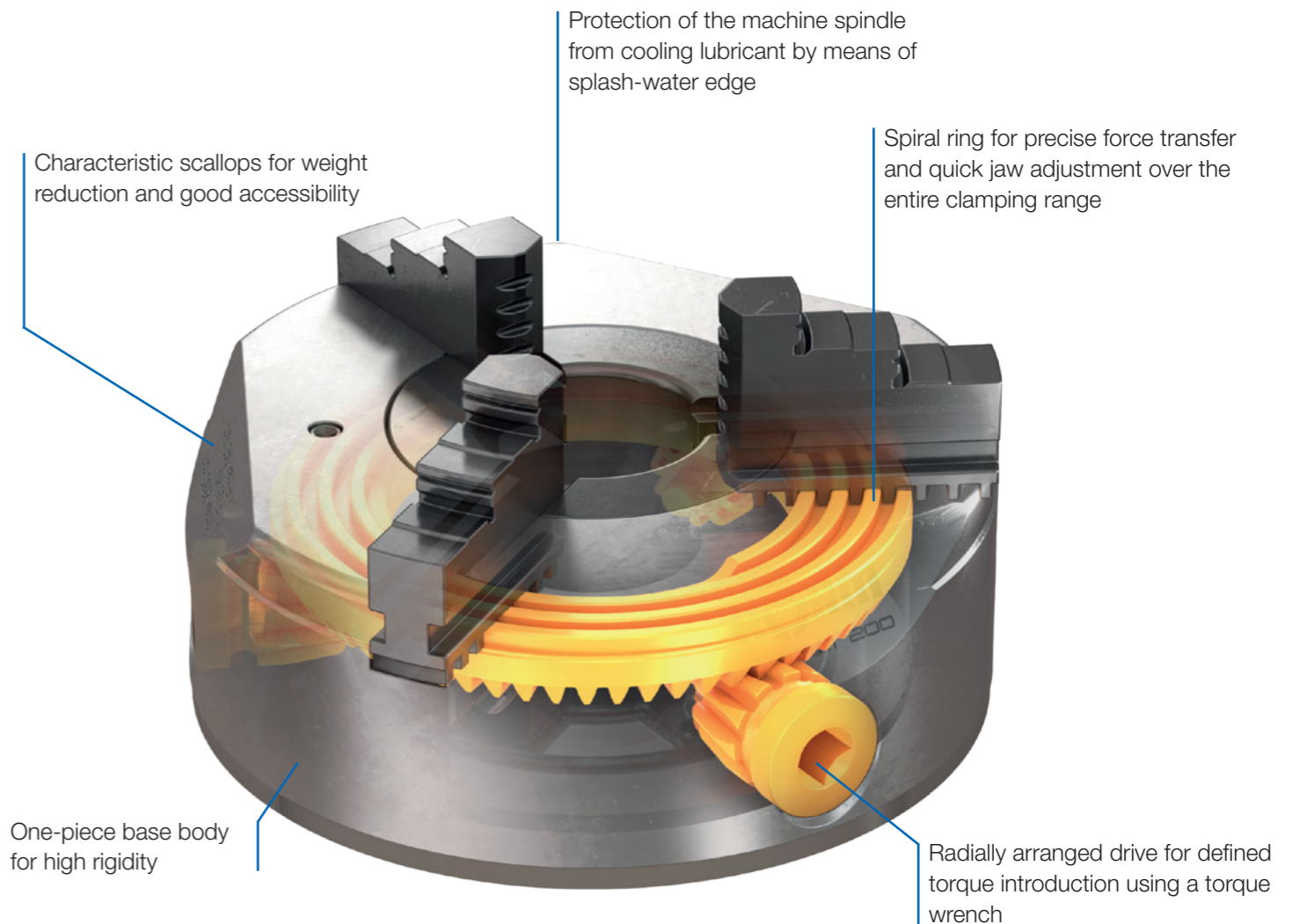

DURO-M - centric clamping



APPLICATION

Conventional clamping horizontal and vertical turning machines, as well as milling machines, rotary tables and dividing attachments. Predominantly for use in single or small batch production or in repair shops. Clamping of rotationally symmetrical parts for turning and milling.

TYPE

The DURO-M is a manually scroll chuck with through-hole. 2-, 3-, 4- or 6-jaw design.

CUSTOMER BENEFITS

- ⊕ Jaws with gunmetal finish
- ⊕ Minimal interference contour
- ⊕ Optimum force transmission
- ⊕ Drip edge for coolant

TECHNICAL FEATURES

- Chuck body made of steel
- Centric clamping via scroll ring
- Scroll plate drop forged and highly tempered
- Jaws in chuck ground out for concentricity
- Zero drive determined in the factory as precision drive
- Scope of delivery: chuck, chuck key, jaws



A09
DIN 6350, cylindrical centre mount, form A

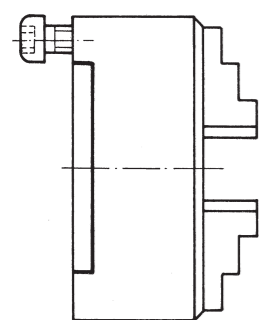

Size	ZA	Through-hole mm	3-jaw chuck with inside and outside jaw	4-jaw chuck with inside and outside jaw	3-jaw chuck with base and reversible top jaw	4-jaw chuck with base and reversible top jaw	Speed max. min ⁻¹	Torque Nm	Total clamping force kN
74	56	15	185299	-	-	-	7000	30	11
80	56	19	185300	185323	-	-	7000	30	13
100	70	20	185301	185324	185310	185333	6300	60	27
125	95	32	185302	185325	185311	185334	5500	80	31
140	105	40	185585	-	-	-	5000	90	40
160	125	42	185303	185326	185312	185335	4600	110	47
200	160	55	185304	185327	185313	185336	4000	140	55
250	200	76	185305	185328	185314	185337	3000	150	63
315	260	103	185306	185329	185315	185338	2300	180	69
400	330	136	185307	185330	185316	185339	1800	240	92
500	420	190	185308	185331	185317	185340	1300	260	100
630	545	240	185309	185332	185318	185341	850	280	105
700	610	310	-	-	185319	185342	800	280	105
800	710	380	-	-	185320	185343	700	300	110
1000	910	460	-	-	185321	185344	560	450	115
1250	910	550	-	-	185322	185345	450	450	115

Further sizes and mountings available on request
From size 400 no scallops due to design

A09
Mounting from front, DIN 6350, cylindrical centre mount

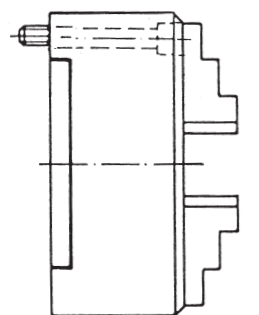

Size	ZA	Through-hole mm	3-jaw chuck with inside and outside jaw	4-jaw chuck with inside and outside jaw	Speed max. min ⁻¹	Torque Nm	Total clamping force kN
125	95	32	185359	185367	5500	80	31
160	125	42	185360	185368	4600	110	47
200	160	55	185361	185369	4000	140	55
250	200	76	185362	185370	3000	150	63
315	260	103	185363	185371	2300	180	69
400	330	136	185364	185372	1800	240	92
500	420	190	185365	185373	1300	260	100
630	545	240	185366	185374	850	280	105

Further sizes and mountings available on request
3-jaw chuck from size 400 no scallops due to design
4-jaw chuck with mounting from front no scallops due to design

DURO-M - centric clamping

A09
ISO 702-1 (DIN 55026), DIN 55021, ASA B 5.9, A1/A2 metr.; mounting from front

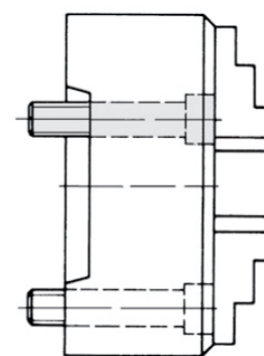

Size	Mount short taper	Through-hole mm	3-jaw chuck with inside and outside jaw	4-jaw chuck with inside and outside jaw	3-jaw chuck with base and reversible top jaw	4-jaw chuck with base and reversible top jaw	Speed max. min ⁻¹	Torque Nm	Total clamping force kN
160	5	42	185375	185402	185389	185417	4600	110	47
200	5	42	185376	185403	185390	185418	4000	140	55
200	6	55	185377	185404	185391	185419	4000	140	55
250	5	76	185378	185405	185392	185420	3000	150	63
250	6	55	185379	185406	185393	185421	3000	150	63
250	8	76	185380	185407	185394	185422	3000	150	63
315	6	103	185381	185408	185395	185423	2300	180	69
315	8	76	185382	185409	185396	185424	2300	180	69
400	8	136	185383	185412	185397	185427	1800	240	92
400	11	125	185384	185413	185398	185428	1800	240	92
500	8	136	185385	-	-	-	1300	260	100
500	11	190	185386	185414	185399	185429	1300	260	100
630	11	190	185387	185415	185400	185430	850	280	105
630	15	190	185388	185416	185401	185431	850	280	105

¹⁾ Mounting from front in the inner bolt circle
3-jaw chuck from size 400 no scallops due to design. 4-jaw chuck with mounting from front no scallops due to design.

A09
ISO 702-2 (DIN 55029), ASA B 5.9, type D, with studs for Camlock

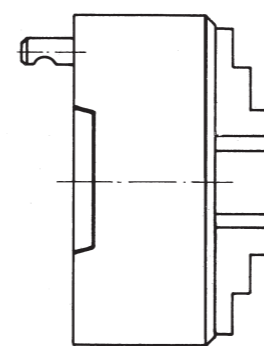

Size	Mount short taper	Through-hole mm	3-jaw chuck with inside and outside jaw	4-jaw chuck with inside and outside jaw	3-jaw chuck with base and reversible top jaw	4-jaw chuck with base and reversible top jaw	Speed max. min ⁻¹	Torque Nm	Total clamping force kN
125	3	32	185432	-	185450	-	5500	80	31
125	4	32	185433	185468	185451	185484	5500	80	31
160	4	42	185434	185469	185452	185485	4600	110	47
160	5	42	185435	185470	185453	185486	4600	110	47
200	5	55	185436	185471	185454	185487	4000	140	55
200	6	55	185437	185472	185455	185488	4000	140	55
250	6	76	185438	185473	185456	185489	3000	150	63
250	8	76	185439	185474	185457	185490	3000	150	63
315	6	103	185440	185475	185458	185491	2300	180	69
315	8	103	185441	185476	185459	185492	2300	180	69
315	11	103	185442	185477	185460	185493	2300	180	69
400	8	136	185443	185478	185461	185494	1800	240	92
400	11	136	185444	185479	185462	185495	1800	240	92
500	8	136	185445	-	185463	-	1300	260	100
500	11	190	185446	185480	185464	185496	1300	260	100
500	15	190	185447	185481	185465	185497	1300	260	100
630	11	192,7	185448	185482	185466	185498	850	280	105
630	15	240	185449	185483	185467	185499	850	280	105

Further sizes and mountings available on request
From size 400 no scallops due to design

A09
ISO 702-3 (DIN 55027), with studs and locknuts, optional DIN 55021 with set screw and nut

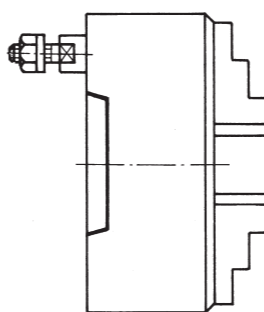

Size	Mount short taper	Through-hole mm	3-jaw chuck with inside and outside jaw	4-jaw chuck with inside and outside jaw	3-jaw chuck with base and reversible top jaw	4-jaw chuck with base and reversible top jaw	Speed max. min ⁻¹	Torque Nm	Total clamping force kN
100	3	20	185500	-	185519	-	6300	60	27
125	3	32	185501	-	185520	-	5500	80	31
125	4	32	185502	185538	185521	185554	5500	80	31
160	4	42	185503	185539	185522	185555	4600	110	47
160	5	42	185504	185540	185523	185556	4600	110	47
200	5	55	185505	185541	185524	185557	4000	140	55
200	6	55	185506	185542	185525	185558	4000	140	55
250	6	76	185507	185543	185526	185559	3000	150	63
250	8	76	185508	185544	185527	185560	3000	150	63
315	6	103	185509	185545	185528	185561	2300	180	69
315	8	103	185510	185546	185529	185562	2300	180	69
315	11	103	185511	185547	185530	185563	2300	180	69
400	8	136	185512	185548	185531	185564	1800	240	92
400	11	136	185513	185549	185532	185565	1800	240	92
500	8	136	185514	-	185533	-	1300	260	100
500	11	190	185515	185550	185534	185566	1300	260	100
500	15	190	185516	185551	185535	185567	1300	260	100
630	11	192,7	185517	185552	185536	185568	850	280	105
630	15	240	185518	185553	185537	185569	850	280	105

Further sizes and mountings available on request
From size 400 no scallops due to design

DURO-M - centric clamping

APPLICATION

Conventional clamping horizontal and vertical turning machines, as well as milling machines, rotary tables and dividing attachments. Predominantly for use in single or small batch production or in repair shops. Clamping of rotationally symmetrical parts for turning and milling.

TYPE

The DURO-M is a manually scroll chuck with through-hole. 2-, 3-, 4- or 6-jaw design.

CUSTOMER BENEFITS

- ⊕ Minimal interference contour
- ⊕ Optimum force transmission
- ⊕ Drip edge for coolant
- ⊕ Control edge

TECHNICAL FEATURES

- Chuck body made of steel
- Centric clamping via scroll ring
- Scroll plate drop forged and highly tempered
- Jaws in chuck ground out for concentricity
- Zero drive determined in the factory as precision drive
- Scope of delivery: chuck, chuck key, jaws



Geared scroll chucks
DURO-M

A09
DIN 6350, cylindrical centre mount, form A

Size	ZA	Through-hole mm	2-jaw chuck with base and reversible top jaw	Speed max. min ⁻¹	Torque Nm	Total clamping force kN
100	70	20	185587	2700	40	18
125	95	32	185588	2400	50	19
160	125	42	185589	2200	70	29
200	160	55	185590	1800	90	35
250	200	76	185591	1500	100	42
315	260	103	185592	1200	120	46
400	330	136	185593	950	160	60

Further sizes and mountings available on request
From size 400 no scallops due to design

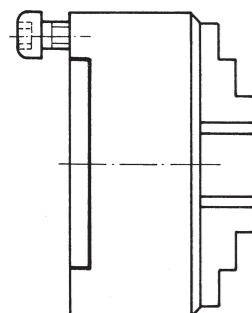

A09
Mounting from front, DIN 6350, cylindrical centre mount

Size	ZA	Through-hole mm	2-jaw chuck with base and reversible top jaw	Speed max. min ⁻¹	Torque Nm	Total clamping force kN
125	95	32	185594	2400	50	19
160	125	42	185595	2200	70	29
200	160	55	185596	1800	90	35
250	200	76	185597	1500	100	42
315	260	103	185598	1200	120	46
400	330	136	185599	950	160	60

Further sizes and mountings available on request
From size 400 no scallops due to design

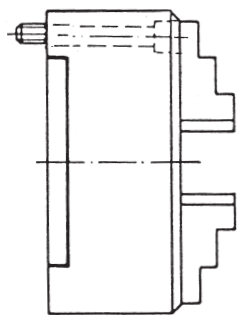

DURO-M - centric clamping

APPLICATION

Conventional clamping horizontal and vertical turning machines, as well as milling machines, rotary tables and dividing attachments. Predominantly for use in single or small batch production or in repair shops. Clamping of rotationally symmetrical parts for turning and milling.

TYPE

The DURO-M is a manually scroll chuck with through-hole. 2-, 3-, 4- or 6-jaw design.

CUSTOMER BENEFITS

- ⊕ Spannbacken grundsätzlich brüniert
- ⊕ Minimal interference contour
- ⊕ Optimum force transmission
- ⊕ Drip edge for coolant
- ⊕ Control edge

TECHNICAL FEATURES

- Chuck body made of steel
- Centric clamping via scroll ring
- Scroll plate drop forged and highly tempered
- Jaws in chuck ground out for concentricity
- Zero drive determined in the factory as precision drive
- Scope of delivery: chuck, chuck key, jaws



Geared scroll chucks
DURO-M

A09
DIN 6350, cylindrical centre mount, form A

Size	ZA	Through-hole mm	6-jaw chuck with inside and outside jaw	Speed max. min ⁻¹	Torque Nm	Total clamping force kN
160	125	42	185347	4600	110	47
200	160	55	185348	4000	140	55
250	200	76	185349	3000	150	63
315	260	103	185350	2300	180	69
400	330	136	185351	1800	240	92

Further sizes and mountings available on request

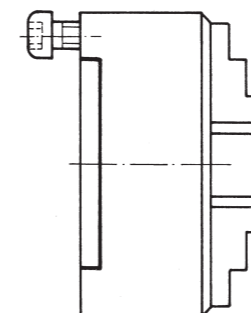

A09
Mounting from front, DIN 6350, cylindrical centre mount

Size	ZA	Through-hole mm	6-jaw chuck with inside and outside jaw	Speed max. min ⁻¹	Torque Nm	Total clamping force kN
160	125	42	185600	4600	110	47
200	160	55	185601	4000	140	55
250	200	76	185602	3000	150	63
315	260	103	185603	2300	180	69
400	330	136	185604	1800	240	92

Further sizes and mountings available on request

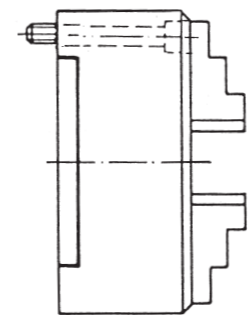

Jaws DURO-M

A09
Inside jaw BB, DIN 6350, outward stepped jaw, hardened



Chuck Size	2-jaw set	3-jaw set	4-jaw set	6-jaw set	Jaw length mm	Jaw height mm	Jaw width mm
74	-	110154	-	-	32	23	10
80	-	110155	110063	-	37	26	12
100	-	110156	110064	-	48	33,5	14
125	-	110157	110065	-	52	41,5	18
140	-	110158	110066	-	61	41,5	18
160	-	110159	110067	150633	61	47,5	18
200	-	110160	110068	150634	69	53,5	20
250	-	110161	110069	150635	90	67,5	24
315	-	110162	110070	150636	130	79,5	34
350/400	-	110163	110071	150637	130	79,5	34
500/630	-	110164	110072	-	190	95	42

Additionally or later applied, hardened stepped jaws must be ground out in the chuck.
For jaws which are applied later, send in the chuck.
1) Reversible, can be used as outside and inside jaws.

A09
Outside jaw DB, DIN 6350, inward stepped jaw, hardened

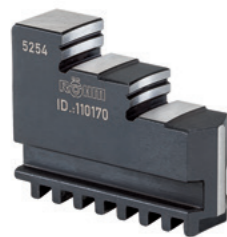

Chuck Size	2-jaw set	3-jaw set	4-jaw set	6-jaw set	Jaw length mm	Jaw height mm	Jaw width mm
80	-	110165	110073	-	37	26	12
100	-	110166	110074	-	48	33,5	14
125	-	110167	110075	-	52	41,5	18
140	-	110168	110076	-	61	41,5	18
160	-	110169	110077	150640	61	47,5	18
200	-	110170	110078	150641	69	53,5	20
250	-	110171	110079	150642	90	67,5	24
315	-	110016	110080	150643	130	79,5	34
350/400	-	110017	110081	150644	130	79,5	34
500/630	-	110018	110082	-	190	95	42

Additionally or later applied, hardened stepped jaws must be ground out in the chuck.
For jaws which are applied later, send in the chuck.

A09
Unstepped jaw BL, DIN 6350, unstepped, soft, material 16MnCr5

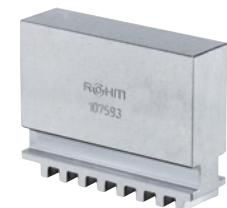

Chuck Size	2-jaw set	3-jaw set	4-jaw set	6-jaw set	Jaw length mm	Jaw height mm	Jaw width mm
74	-	109114	149304	-	32	23	10
80	-	107588	107598	-	37	26	12
100	-	107589	107599	-	48	33,5	14
125	-	107590	107600	-	52	41,5	18
140	-	107591	107601	-	61	41,5	18
160	-	107592	107602	150647	61	47,5	18
200	-	107593	107603	147218	69	53,5	20
250	-	107594	107604	147181	90	67,5	24
315	-	107595	107605	147361	130	79,5	34
350/400	-	107596	107644	151398	130	79,5	34
500/630	-	107597	107645	-	190	95	42

1) Reversible, can be used as outside DB and inside BB jaws.

Jaws DURO-M

A09
Base jaw GB, DIN 6350, with fixing screw

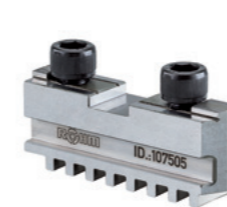

Chuck Size	2-jaw set	3-jaw set	4-jaw set	6-jaw set	Jaw length mm	Jaw width mm
100	108950	107500	107542	-	46	14
125	108951	107501	107543	-	55	18
140	108952	107502	107544	-	65	18
160	108953	107503	107545	150650	65	18
200	108954	107504	107546	150651	78	20
250	108955	107505	107547	150652	92	24
315	108956	107506	107548	150653	108	34
350/400	108957	107507	107549	150654	127	34
500	-	107508	107550	-	165	42
630	-	107509	107551	-	203	42
800	-	105272	141616	-	291	55
1000	-	105274	141611	-	329	55
1250	-	105275	141614	-	367	55

A09
Reversible top jaws UB, DIN 6350, hardened tongue and groove for external and internal clamping, material 16 MnCr5



Chuck Size	2-jaw set	3-jaw set	4-jaw set	6-jaw set	Jaw length mm	Jaw height mm	Jaw width mm
100	-	108045	108053	-	47	29,5	22
125	-	108046	108054	-	56	37,5	26
140/160	-	107936	107938	163832	66,7	41,5	28
200	-	107937	107939	186330	79,5	42,5	30
250	-	108049	108057	153324	95,3	52,5	36
315	-	108050	108058	148771	109,5	57,5	42
350/400	-	108051	108059	153319	127	64,5	42
500/630	-	108052	108060	-	127	79,5	50
800	-	105081	105085	-	210	89	68
1000/1250	-	105098	105101	-	210	110	68

Additionally or later applied hardened jaws must be ground out in the chuck. For jaws which are applied later, send in the chuck.

A09
Unstepped top jaw AB, DIN 6350, soft, material 16MnCr5



Chuck Size	2-jaw set	3-jaw set	4-jaw set	6-jaw set	Jaw length mm	Jaw height mm	Jaw width mm
100	109497	107633	107641	-	53	30	22,5
125	109498	107634	107642	-	62	38	26,5
140/160	109499	108581	108583	186331	74	42	28,5
200	109501	108582	108584	10015381	87	43	30,5
250	109502	107637	107579	186332	103	53	36,5
315	109503	107638	107580	10013705	120	58	42,5
350	-	107639	107581	-	137	65	42,5
400	109504	107639	107581	186333	137	65	42,5
500/630	-	107640	107582	-	140	80	50,5
800	-	105103	105105	-	210	89	68
1000/1250	-	105107	105109	-	210	110	68

Jaws DURO-M

A09
Unstepped jaw BL, special length, soft, material 16MnCr5, DIN 6350

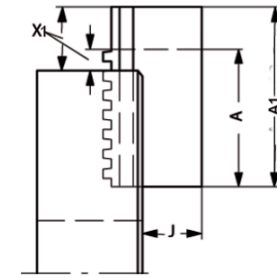

Chuck Size	3-jaw set	4-jaw set	A1 mm	X1 max. mm	A mm	J mm	X max. mm
200	130031	137073	100	50	69	32,5	19
250	132658	137074	120	56	90	41	26
315	132184	129894	160	70	130	46	40
350/400	137075	130442	160	70	130	42	40
500/630	131540	137079	220	80	190	55	50
200	130033	137077	120	70	69	32,5	19
250	128880	130610	140	76	90	41	26
315	118908	137078	200	110	130	46	40
350/400	137079	137080	200	110	130	42	40
500/630	137081	137082	280	140	190	55	50
315	121367	133691	250	160	130	46	40
350/400	137087	137088	250	160	130	42	40

A09
Unstepped jaw BL, special height, soft, material 16MnCr5, DIN 6350

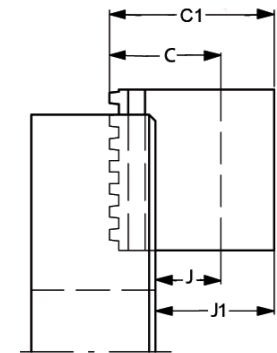

Chuck Size	3-jaw set	4-jaw set	C1 mm	J1 mm	C mm	J mm
200	125710	132972	80	58,5	54	32,5
250	122188	134796	100	73	68	41
315	132186	137091	110	76	80	46
350/400	137092	131655	110	72	80	42
500/630	137093	137094	150	110	95	55
200	125712	137095	120	98,5	54	32,5
250	122189	130630	130	103	68	41
315	137096	137097	140	106	80	46
350/400	137098	137099	140	102	80	42
500/630	125117	137100	200	160	95	55
200	125714	137101	150	128,5	54	32,5
250	137102	137103	150	123	68	41
315	137104	130340	160	126	80	46
350/400	132879	110109	160	122	80	42

Jaws DURO-M

A09
Top jaw AB, special length, soft, material 16MnCr5, DIN 6350

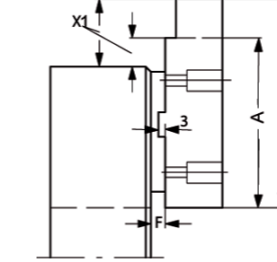

Chuck Size	3-jaw set	4-jaw set	A1 mm	X1 max. mm	F mm	A mm	X max. mm
200	110086	148139	100	43	6,8	87	30
250	112122	129289	130	63	8	103	36
315	110624	143764	160	76	5,5	120	36
350/400	110626	141277	160	53	8,5	137	30
500/630	103014	103393	170	75	8,5	140	45
200	112120	148657	120	63	6,8	87	30
250	125428	128700	150	83	8	103	36
315	112091	147754	200	116	5,5	120	36
350/400	112118	141263	200	93	8,5	137	30
500/630	110632	148234	220	125	8,5	140	45
250	104710	146013	180	113	8	103	36
315	112089	147860	250	166	5,5	120	36
350/400	103654	149974	260	153	8,5	137	30
500/630	112127	148235	280	185	8,5	140	45

A09
Top jaw AB, special height, soft, material 16MnCr5, DIN 6350

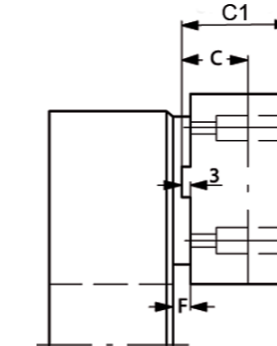

Chuck Size	3-jaw set	4-jaw set	C1 mm	C mm	F mm
200	132155	132181	60	43	6,8
250	119645	135867	70	53	8
315	110435	149975	80	58	5,5
350/400	126385	118373	90	65	8,5
500/630	128590	149985	100	80	8,5
200	128564	149976	80	43	6,8
250	128571	134999	100	53	8
315	110437	129691	110	58	5,5
350/400	110628	135426	120	65	8,5
500/630	110630	149977	130	80	8,5
250	128573	149978	150	53	8
315	128569	141671	150	58	5,5
350/400	128567	139591	160	65	8,5
500/630	128588	140427	160	80	8,5

A09
Top jaw AB, special width and height, soft, material 16MnCr5, DIN 6350

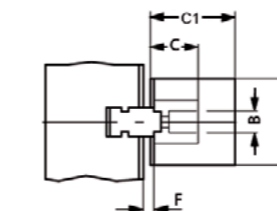

Chuck Size	3-jaw set	4-jaw set	B1 mm	C1 mm	B mm	C mm
200	105057	105061	40	70	30,5	43
250	137090	141338	50	80	36,5	53
315	143063	149979	60	90	42	58
350/400	131567	149980	60	90	42,5	65
500/630	137064	149981	80	110	50,5	80
200	133259	149982	50	80	30,5	43
250	133653	137526	60	90	36,5	53
315	143057	149983	80	110	42	58
350/400	137086	149984	80	110	42,5	65

Jaws DURO-M

C15
Mounting bolt for top jaws, bolt 1



Item no.	Size	Thread	Contents of delivery
249299	100	M6x20	Stück
236949	125	M8x25	Stück
334571	160/200	M8x30	Stück
233025	250	M12x40	Stück
233026	315	M12x45	Stück
220565	350/400	M16x50	Stück
249003	500/630	M20x80	Stück

C15
Mounting bolt for top jaws, bolt 2



Item no.	Size	Thread	Contents of delivery
216528	100	M6x16	Stück
233058	125/160/200	M8x20	Stück
227692	250	M12x25	Stück
233030	315	M12x30	Stück
220564	350/400	M16x35	Stück
233047	500/630	M20x40	Stück



Accessories DURO-M

A09 Base plates for lathe chucks with cylindrical centre mount, DIN 63500

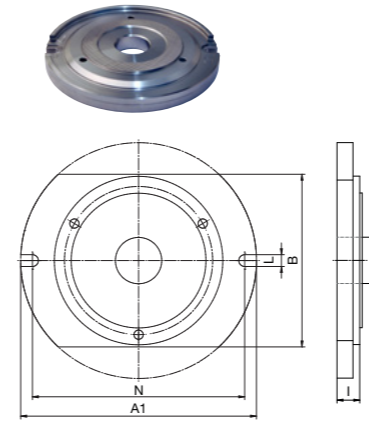

Item no.	Size	A1 mm	B mm	L mm	N mm	E mm	I mm
162793	160	240	-	14	212	42	27
162401	200	280	-	14	252	55	27
163036	250	330	-	18	303	76	27
133705	315	386	320	18	354	103	27
133706	400	470	405	18	438	136	27

A09 Special grease F80 for lathe chucks
For lubrication and conservation of chucking power



Item no.	Design	Contents
308555	Cartridge (DIN 1284) Ø 53.5x235mm	0,5 kg
028975	Tin	1 kg

A09 Chip guard, piece



Item no.	Size	Contents of delivery
108500	80/85	piece
108501	100	piece
108502	125	piece
108503	140/160	piece
108504	200	piece
108505	250	piece
108506	315/400	piece
108508	500/630	piece

C15 Grease gun DIN1283



Item no.	Connection	Contents of delivery
329093	M10x1	150 mm nozzle tube bent, needlepoint mouthpiece, top mouthpiece, 300 mm high pressure hose with 4 jaw hydraulics cross mouthpiece

A09 Scroll



Item no.	Size
102521	74
102183	80/85
101754	100
112660	110
101721	125
105827	140
100303	160
100003	200
100203	250
101552	315
105228	350
102497	400
162973	500
162964	630

A09 Driving pinion



Item no.	Size	Square
102522	74	6
102184	80	6
113198	85	6
101755	100	8
112662	110	8
101722	125	9
105828	140	9
100304	160	10
100005	200	11
100204	250	12
112267	270	12
101553	315	14
105229	350	14
102498	400	17
162974	500	19
162965	630	19

A09 Pinion holder screw



Item no.	Size
102523	74
102185	85
100305	100/125/160
100006	200/250
101554	315
102499	400
103300	500/630

A09 Standard key



Item no.	Size	Square	Hexagon	Length mm
107425	74	-	6	62
107426	80/85	6	-	62
107427	100/110	8	-	75
107428	125/140	9	-	80
107429	160	10	-	90
107430	200/230	11	-	100
107431	250/270	12	-	100
107432	315	14	-	110
107433	350	14	-	140
107434	400	17	-	140
107435	500/630	19	-	150

Accessories DURO-M

A09 Safety key with ejector



Item no.	Size	Square	Length mm
154370	80/85	6	110
154371	100/110	8	130
154372	125/140	9	130
154373	160	10	160
154374	200/230	11	160
154375	250/270	12	160
154376	315	14	200
154377	350	14	200
154378	400	17	250
154379	500/630/700/800	19	250
160917	1000/1250	25	200

A09 Elongated safety key with ejector



Item no.	Size	Square	Length mm
154683	125/140	9	170
154685	160	10	180
154687	200/230	11	200
154689	250/270	12	200
154695	315	14	250

A09 Safety adapter with ejector

For actuating the chuck with torque (defined torque introduction)



Item no.	Size	Square	Inch
178566	80/85	6	3/8
178567	100/110	8	1/2
178568	125/140	9	1/2
178569	160	10	1/2
178570	200/230	11	1/2
178571	250/270	12	1/2
178572	315/350	14	1/2
178573	400	17	1/2
178574	500/630/700/800	19	3/4
178575	1000/1250	24	3/4

A09 Torque wrench



Item no.	Torque Nm	Length mm	Output	Working accuracy
10004116	20-120	435	12,7=1/2"	3%
10004117	60-320	659	12,7=1/2"	3%

C15 Mounting screws

For cylindrical centre rim



Item no.	Size	Thread	Contents of delivery
249299	74-85	M6x20	piece
334571	100-140	M8x30	piece
249301	160-230	M10x35	piece
233025	250-270	M12x40	piece
220565	315-350	M16x50	piece
229183	400-630	M16x60	piece

C15 Mounting screws

For lathe chucks with direct short-taper, for front mounting



Item no.	Size	Thread	Contents of delivery	Chuck Size	Taper size
302195	74	M10x55	piece	160	5
200184	80	M10x65	piece	200	5
233006	85	M12x65	piece	200	6
233075	100	M10x90	piece	250	5
216549	110	M12x70	piece	250	6
302194	125	M16x70	piece	250	8
242954	140	M12x100	piece	315	6
358816	160	M16x85	piece	315	8
243665	200/230	M12x130	piece	350	6
236516	315	M16x110	piece	400	8
615744	350	M20x95	piece	400	11
010210	400	M20x130	piece	500	11
328925	500	M20x145	piece	630	11
367648	630	M24x125	piece	630	15

A09 Set screw with nut, DIN 55021



Item no.	Thread	For taper	Quantity
107453	M10x30	4	3
107455	M10x35	5	4
107456	M12x40	6	4
107457	M16x45	8	4
107458	M20x55	11	6
127618	M24x65	15	6

A09 Stud for Camlock ISO 702-2 (DIN 55029) and cylindrical studs



Item no.	Thread	For taper	Quantity
178364	M10x1	3	3
178365	M10x1	4	3
178366	M12x1	5	6
178367	M16x1,5	6	6
178368	M20x1,5	8	6
178369	M22x1,5	11	6
178370	M24x1,5	15	6
178371	M27x2	20	6

Accessories DURO-M

A09 Stud and locknut ISO 702-3 (DIN 55027)



Item no.	Thread	Contents of delivery	For taper	Quantity
107447	M10x34	Stück	3	3
107448	M10x39	Stück	4	3
107449	M10x43	Stück	5	4
107450	M12x50	Stück	6	4
107451	M16x60	Stück	8	4
107452	M20x75	Stück	11	6
125650	M24x90	Stück	15	6
130636	M24x100	Stück	20	6

A09 Stud for Camlock ASA B 5.9 (DIN 55029) and cylindrical studs



Item no.	Thread	For taper	Quantity
107465	7/16-20x35	3	3
107466	7/16-20x37	4	3
107467	1/2-20x43	5	6
107468	5/8-18x49	6	6
107469	3/4-16x55,5	8	6
107470	7/8-14x67	11	6
127621	1-14x76	15	6
130637	1 1/2-12x89	20	6

Chuck dimensions DURO-M

For mounting on dividing heads and other attachments from the front, the lathe chucks with a cylindrical centre mount can also be supplied pre-drilled (at surcharge) G₁, it is also possible to enlarge the bore (measure E, at surcharge).

Cylindrical centre mount DIN 6350

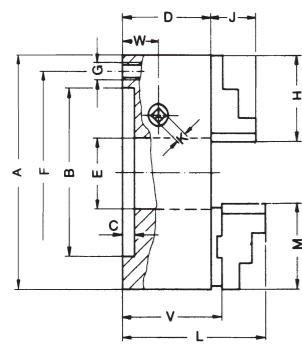

Size A	74	80	100	125	140	160	200	250	315	400	500	630
B ¹⁶	56	56	70	95	105	125	160	200	260	330	420	545
C	2,5	3	3	4	4	4	4	5	5	5	5	7
D	32,5	39,5	50	56	60	65	73,5	82	95	105	120	135
E	15	19	20	32	40	42	55	76	103	136	190	240
E ^{max}	-	-	21	33	43	50	70	92	114	150	210	253
F	63	67	83	108	120	140	176	224	286	362	458	586
G	3xM6	3xM6	3xM8	3xM8	3xM8	3xM10	3xM10	3xM12	3xM16	3xM16	6xM16	6xM16
3B	G1	-	-	3xØ9	-	3xØ10,5	3xØ11	3xØ14	3xØ14	3xØ18	6xØ18	6xØ18
4B	G1	-	-	4xØ9	-	3xØ10,5	3xØ11	3xØ14	3xØ14	3xØ18	6xØ18	6xØ18
2B	G1	-	-	4xØ9	-	4xØ10,5	4xØ11	4xØ14	4xØ14	4xØ18	-	-
H	32	37	48	52	61	69	90	130	130	190	190	190
J	14	14	18	22,5	22,5	26	32,5	40	46	43	54,5	54,5
K	6 ¹⁾	6	8	9	9	10	11	12	14	17	19	19
L	-	-	80,5	95,5	106	108	119,6	139,6	155	171,5	201,5	216,5
M	-	-	47	56	66,7	66,7	79,5	95	109,5	127	127	127
V	-	-	53,6	61	-	69,7	80,2	89,9	100,4	113,4	128,4	143,3
W	13	14,5	18	20	21	22,45	25,7	26,5	30	35	38	48
3+4B ²⁾	R	5,5	8	10	10	11	13	16	20	24	-	-
	S	30°	30°	30°	26°	26°	30°	30°	30°	-	-	-
2B	R	-	-	17	20	-	23	25	32	38	-	-
	S	-	-	30°	30°	-	30°	30°	30°	-	-	-
	T	-	-	24°	-	25°	25°	30°	30°	-	-	-
kg	0,9	1,3	2,5	4,3	5,7	7,5	13,0	22,8	43,3	75	131	217

Enlarged bore max.

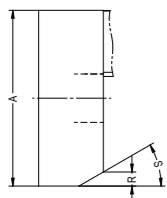

G₁ = Mounting from front * 4-jaw = 4 x Ø9

Position of the fastening screws for lathe chucks with cylindrical centring mount size 74-630

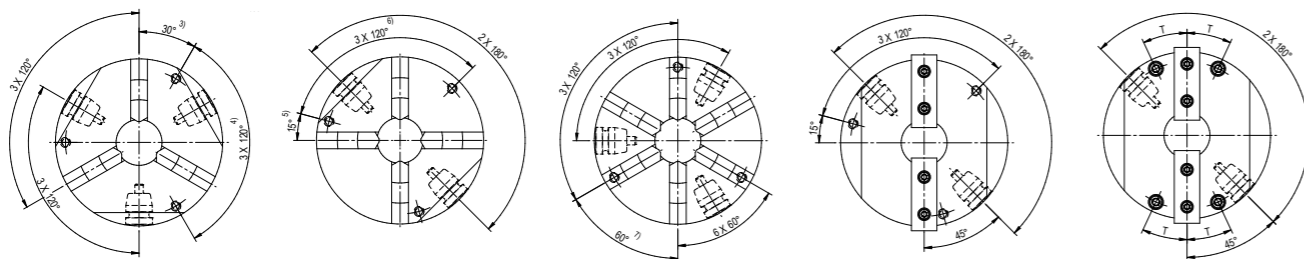

¹⁾ Hexagon, ²⁾ 25° for size 125-315 with fastening from the front, ³⁾ 6 X 60° for size 500 and 630, ⁴⁾ 25° for size 125 with fastening from the front, ⁵⁾ 4x90° for size 125 with fastening from the front, ⁶⁾ 6x60° for size 500 and 630, ⁷⁾ 30° for fastening from the front, ⁸⁾ not for 4B-chuk with fastening from the front

Cylindrical centre mount with front mounting

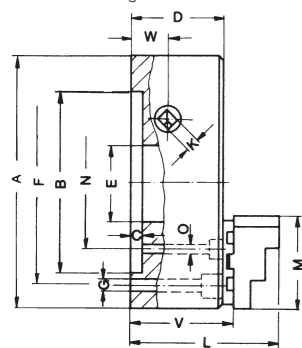

Size	ØA	700	800	1000	1250
B		610	710	910	910
C ²⁾		7 ^{+0,03}	7 ^{+0,03}	7 ^{+0,03}	7 ^{+0,03}
D		147	147	157	157
E		310	380	460	550
E ^{max}		330	420	580	580
F		660	760	950	950
3-Jaw	G	6xØ22	6xØ22	6xØ26	6xØ26
4-Jaw	G	8xØ22	8xØ22	8xØ26	6xØ26
K		19	19	24	24
L		240,6	240,6	269,6	269,6
M		210	210	210	210
N		360	460	610	610
3-Jaw	O	6xØ18	6xØ18	6xØ18	6xØ18
4-Jaw	O	4xØ18	4xØ18	4xØ18	6xØ18
V		158	158	166	166
W		48	48	53	53
ca. kg		280	350	590	850

²⁾ Adaptor plate dimension 7^{-0,03}

Position of fixing screws and pinions on lathe chucks with cylindrical centre mount sizes 74-630 (size 350 on request)

Size 700-1250

Size 700-1000

Size 1250

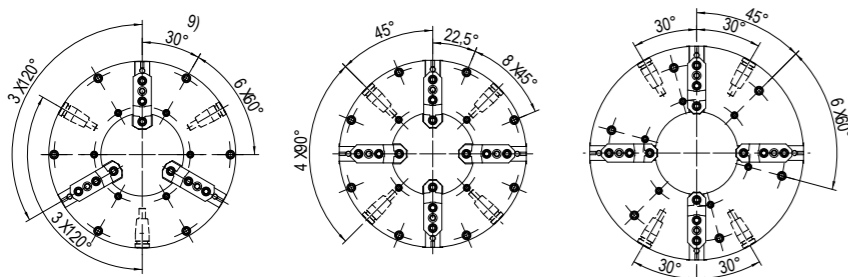

³⁾ 25° for size 1250

Chuck dimensions DURO-M

Short taper mount

DIN 55021 with setscrews and locknuts



DIN 55027 with studs and nuts

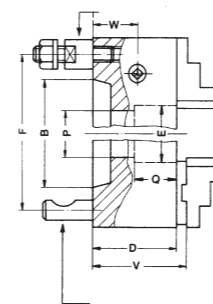

DIN 55029 with studs for Camlock

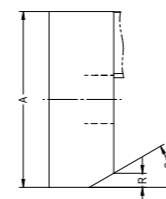

Size	A	100	125	160	200					
Taper size	B	3	3	4	4	5	3	4	5	6
	D	53,9	53,9	63,5	63,5	82,5	53,9	63,5	82,5	106,4
	E	75	69	69	66	66	74,5	74,5	74,5	74,5
DIN Caml.	F	20	32	32	42	42	51,2	55	55	55
	P	75	75	85	85	104,8	75	85	104,8	133,4
	Q	70,6	70,6	82,5	82,5	-	70,6	82,5	104,8	133,4
	V	-	-	-	-	-	51,2	-	-	-
	W	-	-	-	-	-	33	-	-	-
	R	-	-	-	-	-	-	-	-	-
	S	-	-	-	-	-	-	-	-	-
Mounting holes	DIN	3	3	3	3	4	3	3	4	4
	Caml.	3	3	3	3	6	3	3	6	6
ca. kg		4	5,5	8,5	-	-	-	-	-	15,5

¹⁾ 50 with Camlock, other dimensions in the table on the top

Short taper mount

DIN 55021 with setscrews and locknuts

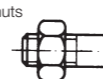

DIN 55027 with studs and nuts

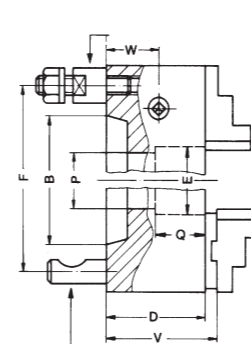

DIN 55029 with studs for Camlock

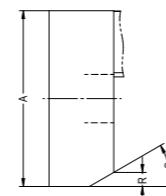

Size A	250	315		350			400			
Taper size	6	8	6	8	11	6	8	11	8	11
B	106,4	139,7	106,4	139,7	196,9	106,4	139,7	196,9	139,7	196,6
D	83	83	96	96	104	122	122	122	106	106
E	76	76	103	103	103	103	115	115	136	136
F	133,4	171,4	133,4	171,4	235	133,4	171,4	235	171,4	235
P	-	-	-	-	-	103	-	-	-	-
Q	-	-	-	-	-	81	-	-	-	-
V	90,9	90,9	101,4	101,4	109,4	127,4	127,4	127,4	114,4	114,4
W	27,5	27,5	31	31	39	56	56	56	36	36
R	20	20	24	24	24	-	-	-	-	-
S	30°	30°	30°	30°	30°	-	-	-	-	-

Size A	500		630		
Taper size	8	11	15	11	15
B	139,7	196,9	285,8	196,9	285,8
D	122	122	122	137	137
E	136	190	190	192,7	240
F	171,4	235	330,2	235	330,2
P	136	-	-	192,7	-
Q	61	-	-	63	-
V	130,4	130,4	130,4	145,3	145,3
W	40	40	40	50	50
R	130,4	130,4	130,4	145,3	145,3
S	40	40	40	50	50
Mounting holes	DIN	4	6	6	6
	Caml.	6	6	6	6
approx. kg		150		225	

All other dimensions should be taken from the table about chucks with cylindrical centre mount

Chuck dimensions DURO-M

Short taper mount
DIN 55026
Mounting from front

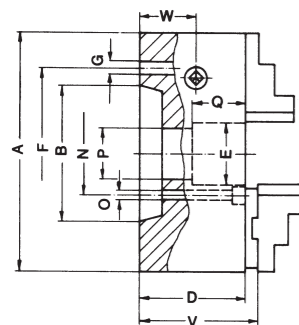

Size A	160	200	250	315	400
Taper size	5	5	6	8	8
B	82,5	106,4	82,5	106,4	139,7
D	66	74,5	83	96	106
E	42	55	76	103	136
F ²⁾	-	-	104,8	133,4	171,4
G	-	-	11 ¹⁾	14	18
N ³⁾	61,9	82,6	82,6	111,1	165,1
O	11 ¹⁾	14	14	18	22
V	70,7	81,2	90,9	101,4	114,4
W	23,45	26,7	27,5	31	36
R	13	16	20	24	-
S	30°	30°	30°	30°	-
Mounting holes	* 3	3	6	6	6
	** 4	4	4	4	4
approx. kg	8	14,5	25	44,5	82

Size ØA	500	630	700	800	1000	1250
Taper size	8	11	11	15	15	20
B	139,7	196,9	285,9	285,9	412,8	412,8
D	122	137	149	149	159	159
E	136	190	310	380	460	550
F ²⁾	171,4	235	235	330,2	463,6	463,6
G	18	22	22	26	26	26
N ³⁾	-	-	247,6	-	-	-
O	-	-	26	-	-	-
P	-	-	193	281,2	281,2	407,5
Q	-	-	76	76	85	85
V	130	145,3	159,9	159,9	168	168
W	40	50	50	50	55	55
Mounting holes	* 6	6	6	6	6	6
	** 8	8	8	8	8	8
approx. kg	151	220	295	350	590	850

¹⁾ 12 bei ASA B 5.9 A1 / A2 Zoll ²⁾ für DIN 55026 Form A und B; DIN 55021 Form A und B; ASA B 5.9 A1 / A2 ³⁾ für DIN 55026 Form B; ASA B 5.9 A1 / B1
* 3-Backen ** 4-Backen

Chucking capacities of jaw steps (standard values)

Size	74	80	100	125	140	160	200	250
A1 (BB)	2-24	2-30	3-38	3-53	3-53	4-72	4-100	5-122
A2 (DB)	2-24	2-30	3-38	3-53	3-53	3-72	4-100	5-122
A3 (DB)	23-46	27-55	38-71	39-89	47-97	47-116	56-152	73-190
A4 (DB)	45-68	52-80	70-100	75-125	91-140	91-160	104-200	131-250
max. swing dia.	88	104	128	157	174	194	238	302
Jaw movement	11	14	15	25	25	34	48	58

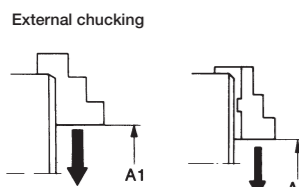

Size	315	400	500	630	700	800	1000	1250
A1	6-135	20-200	35-260	50-350	110-350	150-450	250-600	320-600
A2	6-135	20-200	35-260	50-350	280-672	325-853	425-1070	490-1150
A3	96-225	110-300	140-360	190-490	356-748	400-928	500-1150	564-1224
A4	186-315	200-400	280-500	330-630	-	-	-	-
max. swing dia.	395	480	600	730	1000	1170	1390	1476
Jaw movement	64	100	110	150	120	150	175	140

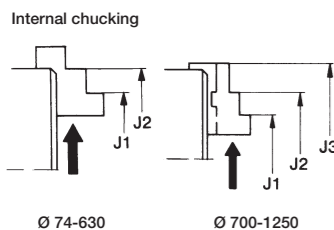
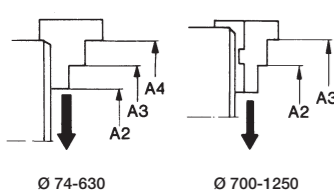

Size	74	80	100	125	140	160	200	250
J1	23-46	25-53	33-66	37-87	39-89	39-107	44-140	59-165
J2	45-68	50-78	65-94	73-123	83-132	83-152	92-186	119-236

Size	315	400	500	630	700	800	1000	1250
J1	96-224	100-300	135-355	150-450	212-648	251-855	356-1080	426-1162
J2	186-305	190-390	275-460	290-590	290-758	326-930	430-1150	500-1236
J3	-	-	-	-	526-922	566-1094	660-1314	740-1400

Clamping ranges for lathe chucks with individual adjustable jaws (ES) are in approximate conformity with the above values. They are valid for 3- and 4-jaw chucks and lathe chucks with reversible jaws.
Do not exceed maximum chucking ranges.

Jaw dimensions DURO-M

External chucking

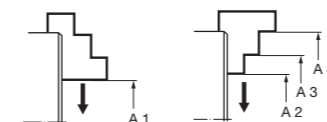

Internal chucking

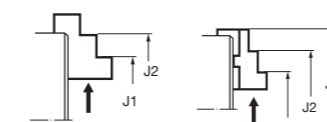

Chuck capacities of jaw steps (reference values)

valid for 6-jaw chuck

Size	160	200	250	315	400
A1 (BB)	8-72	9-100	14-122	15-135	20-200
A2 (DB)	8-72	9-100	14-122	15-135	20-200
A3 (DB)	52-116	61-152	81-190	105-225	110-300
A4 (DB)	96-160	109-200	141-250	195-315	200-400
Biggest rotation-Ø	194	238	302	395	480
Jaw stroke	32	45	54	60	100

Size	160	200	250	315	400
J1	46-107	51-140	70-165	100-224	100-300
J2	89-152	97-186	128-236	190-305	190-390

Max. permissible speeds for ZS - ZSU, Orange Line, ZS Hi-Tru to DIN 6350

The maximum permissible speed has been fixed so that 1/3 of the gripping force is still available as residual gripping force if the maximum gripping is applied and the chuck is fitted with its heaviest jaws. The jaws may not project beyond the outside diameter of the chuck. The chuck must be in perfect condition. The speed limit for chucks with cast iron bodies is based on the permissible peripheral speed for cast iron. The specification DIN 6386 Part 1 shall be observed.

Size	3 and 4 jaws Steel body
74	-
80	7000
100	6300
125	5500
140	5000
160	4600
200	4000
250	3000
315	2300
400	1800
500	1300
630	850
700	800
800	700
1000	560
1250	450

Clamping force 3 jaw chuck ZS - ZSU, Orange Line, ZS Hi-Tru to DIN 6350

The clamping force is sum total of all jaw forces acting radially on the stationary workpiece. The clamping forces are approximate values. To obtain the specified clamping forces, the chuck must be in a perfect condition and lubricated with F 80 lubricant recommended by RÖHM.

Size	Torque key	Total clamping force
74	30	11
80	30	13
100	60	27
125	80	31
140	90	40
160	110	47
200	140	55
250	150	63
315	180	69
400	240	92
500	260	100
630	280	105
700	280	105
800	300	110
1000	450	115
1250	450	115

ZS Hi-Tru - with fine adjustment



APPLICATION

Optimized for machining workpieces which must be produced with **maximum concentricity**. Can be universally used, but is especially advantageous on turning and grinding machines as well as dividing units.

TYPE

Lathe and grinding chuck in steel design with which the workpiece can be adjusted very sensitively to the desired concentricity via 3 tangentially arranged adjusting spindles.

CUSTOMER BENEFITS

- ⊕ Radial fine adjustment for maximum concentricity
- ⊕ Repeatability 0.015 mm
- ⊕ Adjusting accuracy within 0.005 mm
- ⊕ Precision adjustment without opening the mounting screws
- ⊕ Jaws in chuck ground out for concentricity

TECHNICAL FEATURES

- With one set outside jaws and one set inside jaws
- Hardened adjusting spindles as well as their support surfaces
- Hardened spiral ring
- Steel take-up flange

ZS Hi-Tru = centric clamping, steel, maximum precision

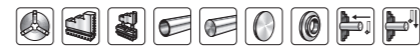

ZS Hi-Tru - with fine adjustment

Dimensions ZS Hi-Tru, DIN 6350, cylindrical centre mount, Form A

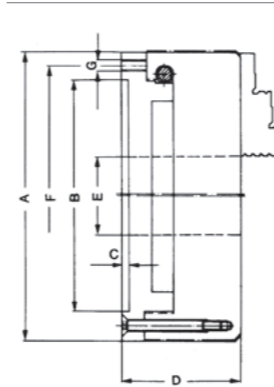

Size A	Inch	B+0,02	C	D	F	G	SW	Weight
ZS Hi-Tru, with 1 set each outward or inward stepped jaws								
80	3 1/4	56	3	50,5	67	3xM6	4	1,7
100	4	70	3	63	83	3xM8	5	3,6
125	5	95	4	72	108	3xM8	5	5,6
160	6 1/4	125	4	81	140	3xM10	6	10
200	8	160	4	89,5	176	3xM10	6	17,2
250	10	200	5	102	224	3xM12	8	34,5
315	12 1/2	260	5	122	286	3xM16	8	57,5
ZS Hi-Tru, with special seal for grinding machines								
80	3 1/4	56	3	50,5	67	3xM6	4	1,7
100	4	70	3	63	83	3xM8	5	3,6
125	5	95	4	72	108	3xM8	5	5,6
160	6 1/4	125	4	81	140	3xM10	6	10
200	8	160	4	89,5	176	3xM10	6	17,2
250	10	200	5	102	224	3xM12	8	34,5
315	12 1/2	260	5	122	286	3xM16	8	57,5

Fine adjustment

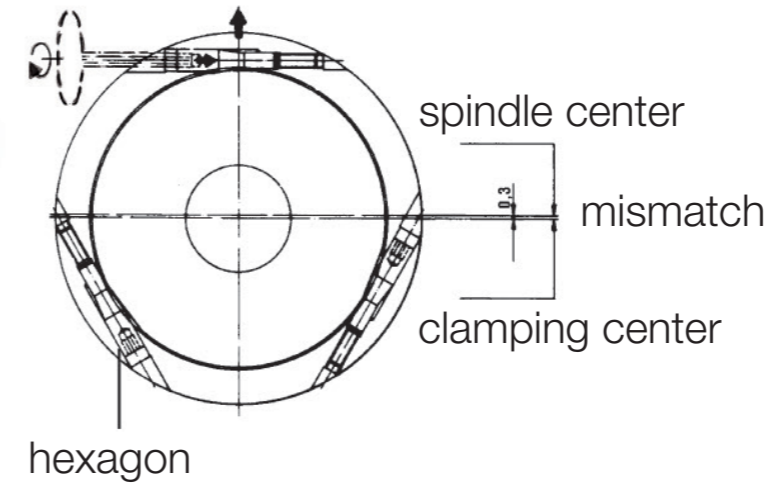

A09

ZS Hi-Tru, with one set outward stepped jaws and one set inward stepped jaws, DIN 6350, cylindrical centre mount, form A



Item no.	Size	ZA	Through-hole mm	Speed max. min ⁻¹	Torque Nm	Total clamping force kN
180259	80	56	19	7000	30	13
180261	100	70	20	6300	60	27
180263	125	95	32	5500	80	31
180265	160	125	42	4600	110	47
180267	200	160	55	4000	140	55
180269	250	200	76	3000	150	63
180271	315	260	103	2300	180	69

On request from size 125 with 6-jaws or with short-taper mount to ISO 702-3 (DIN 55027) or ISO 702-2 (DIN 55029) Camlock
Further sizes and mountings available on request

A09

ZS Hi-Tru, with special seal for grinding machines, DIN 6350, cylindrical centre mount, form A

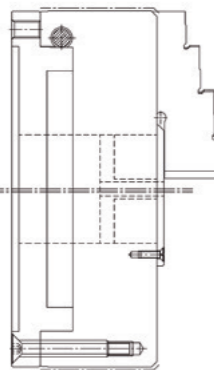

Item no.	Size	ZA	Through-hole mm	Speed max. min ⁻¹	Torque Nm	Total clamping force kN
180273	80	56		5000	30	13
180275	100	70		4500	60	27
180277	125	95	7	4000	80	31
180279	160	125	7	3600	110	47
180281	200	160	8	3000	140	55
180283	250	200	10	2500	150	63
180285	315	260	16	2000	180	69

On request from size 125 with 6-jaws or with short-taper mount to ISO 702-3 (DIN 55027) or ISO 702-2 (DIN 55029) Camlock



Video functioning ZS Hi-Tru

Jaws ZS Hi-Tru

A09
Inside jaw BB, DIN 6350, outward stepped jaw, hardened



Item no.	Chuck Size	Number of jaws	Contents of delivery	Jaw length mm	Jaw height mm	Jaw width mm
110155	80	3	set	37	26	12
110156	100	3	set	48	33,5	14
110157	125	3	set	52	41,5	18
110159	160	3	set	61	47,5	18
110160	200	3	set	69	53,5	20
110161	250	3	set	90	67,5	24
110162	315	3	set	130	79,5	34

Additionally or later applied, hardened stepped jaws must be ground out in the chuck.
For jaws which are applied later, send in the chuck.

A09
Outside jaw DB, DIN 6350, inward stepped jaw, hardened



Item no.	Chuck Size	Number of jaws	Contents of delivery	Jaw length mm	Jaw height mm	Jaw width mm
110165	80	3	set	37	26	12
110166	100	3	set	48	33,5	14
110167	125	3	set	52	41,5	18
110169	160	3	set	61	47,5	18
110170	200	3	set	69	53,5	20
110171	250	3	set	90	67,5	24
110016	315	3	set	130	79,5	34

Additionally or later applied, hardened stepped jaws must be ground out in the chuck.
For jaws which are applied later, send in the chuck.

A09
Unstepped jaw BL, DIN 6350, unstepped, soft, material 16MnCr5

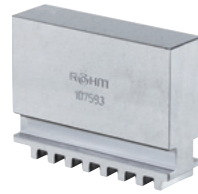

Item no.	Chuck Size	Number of jaws	Contents of delivery	Jaw length mm	Jaw height mm	Jaw width mm
107588	80	3	set	37	26	12
107589	100	3	set	48	33,5	14
107590	125	3	set	52	41,5	18
107592	160	3	set	61	47,5	18
107593	200	3	set	69	53,5	20
107594	250	3	set	90	67,5	24
107595	315	3	set	130	79,5	34

A09
Base jaw GB, DIN 6350, with fixing screw

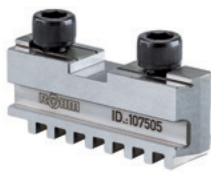

Item no.	Chuck Size	Number of jaws	Contents of delivery	Jaw length mm	Jaw width mm
107500	100	3	set	46	14
107501	125	3	set	55	18
107503	160	3	set	65	18
107504	200	3	set	78	20
107505	250	3	set	92	24
107506	315	3	set	108	34

A09
Reversible top jaws UB, DIN 6350, hardened tongue and groove for external and internal clamping, material 16 MnCr5



Item no.	Chuck Size	Number of jaws	Contents of delivery	Jaw length mm	Jaw height mm	Jaw width mm
108045	100	3	set	47	29,5	22
108046	125	3	set	56	37,5	26
107936	160	3	set	66,7	41,5	28
107937	200	3	set	79,5	42,5	30
108049	250	3	set	95,3	52,5	36
108050	315	3	set	109,5	57,5	42

Additionally or later applied, hardened stepped jaws must be ground out in the chuck.
For jaws which are applied later, send in the chuck.

Jaws ZS Hi-Tru

A09
Unstepped top jaw AB DIN 6350, soft, material 16MnCr5



Item no.	Chuck Size	Number of jaws	Contents of delivery	Jaw length mm	Jaw height mm	Jaw width mm
107633	100	3	set	53	30	22,5
107634	125	3	set	62	38	26,5
108581	160	3	set	74	42	28,5
108582	200	3	set	87	43	30,5
107637	250	3	set	103	53	36,5
107638	315	3	set	120	58	42,5

A09
Unstepped jaw BL, special length, soft, material 16MnCr5, DIN 6350



Item no.	Chuck Size	A1 mm	X1 max.	A	J	X max.
130031	200	100	50	69	32,5	19
132658	250	120	56	90	41	26
132184	315	160	70	130	46	40
130033	200	120	70	69	32,5	19
128880	250	140	76	90	41	26
118908	315	200	110	130	46	40
121367	315	250	160	130	46	40

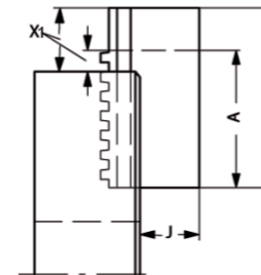

A09
Unstepped jaw BL, special height, soft, material 16MnCr5, DIN 6350



Item no.	Chuck Size	C1	J1	C	J
125710	200	80	58,5	54	32,5
122188	250	100	73	68	41
132186	315	110	76	80	46
125712	200	120	98,5	54	32,5
122189	250	130	103	68	41
137096	315	140	106	80	46
125714	200	150	128,5	54	32,5
137102	250	150	123	68	41
137104	315	160	126	80	46

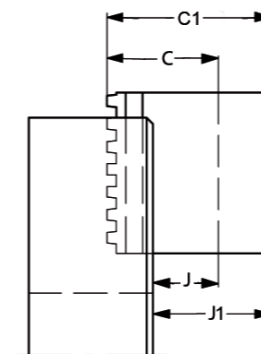

Jaws ZS Hi-Tru

A09
Top jaw AB, special length, soft, material 16MnCr5, DIN 6350

Item no.	Chuck Size	A1 mm	X1 max.	F	A	X max.
110086	200	100	43	6,8	87	30
112122	250	130	63	8	103	36
110624	315	160	76	5,5	120	36
112120	200	120	63	6,8	87	30
125428	250	150	83	8	103	36
112091	315	200	116	5,5	120	36
104710	250	180	113	8	103	36
112089	315	250	166	5,5	120	36

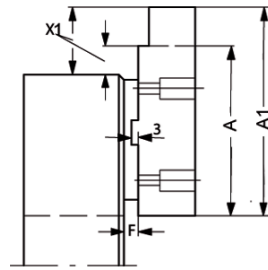

A09
Top jaw AB, special height, soft, material 16MnCr5, DIN 6350

Item no.	Chuck Size	C1	C	F
132155	200	60	43	6,8
119645	250	70	53	8
110435	315	80	58	5,5
128564	200	80	43	6,8
128571	250	100	53	8
110437	315	110	58	5,5
128573	250	150	53	8
128569	315	150	58	5,5

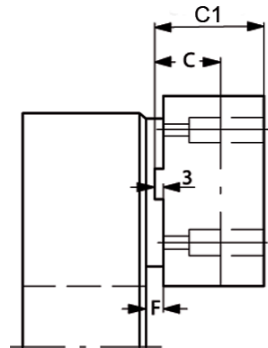

A09
Top jaw AB, special width and height, soft, material 16MnCr5, DIN 6350

Item no.	Chuck Size	B1	C1	B	C
105057	200	40	70	30.5	43
137090	250	50	80	36.5	53
143053	315	60	90	42	58
133259	200	50	80	30.5	43
133653	250	60	90	36.5	53
143057	315	80	110	42	58

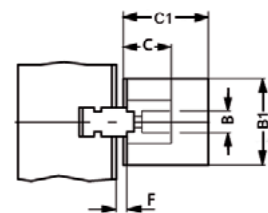

Jaws ZS Hi-Tru

C15
Mounting bolt for top jaws, bolt 1

Item no.	Size	Thread	Contents of delivery
249299	100	M6x20	piece
236949	125	M8x25	piece
334571	160/200	M8x30	piece
233025	250	M12x40	piece
233026	315	M12x45	piece



C15
Mounting bolt for top jaws, bolt 2

Item no.	Size	Thread	Contents of delivery
216528	100	M6x16	piece
233058	125/160/200	M8x20	piece
227692	250	M12x25	piece
233030	315	M12x30	piece



Accessories ZS Hi-Tru

A09 Base plates for lathe chucks with cylindrical centre mount, DIN 6350

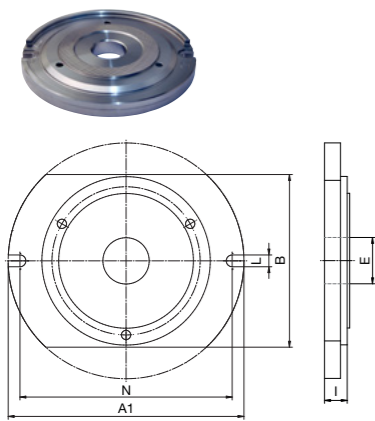

Item no.	Size	A1 mm	B mm	L mm	N mm	E mm	I mm
162793	160	240	-	14	212	42	27
162401	200	280	-	14	252	55	27
163036	250	330	-	18	303	76	27
133705	315	386	320	18	354	103	27
133706	400	470	405	18	438	136	27

C15 Special grease F80 for lathe chucks
For lubrication and conservation of chucking power



Item no.	Design	Contents
308555	Cartridge (DIN 1284) Ø 53.5x235mm	0,5 kg
028975	Tin	1 kg

A09 Driving pinion



Item no.	Size	Hexagon
178473	100	9
178474	110	9
178475	125	10
178476	140	10
178477	160	11
178478	200	12
178480	250	14
178482	315	17

A09 Standard key



Item no.	Size	Square	Length mm
107426	80/85	6	62
107427	100/110	8	75
107428	125/140	9	80
107429	160	10	90
107430	200/230	11	100
107431	250/270	12	100
107432	315	14	110

C15 Grease gun DIN1283



Item no.	Connec- tion	Contents of delivery
329093	M10x1	150 mm nozzle tube bent, needlepoint mouthpiece, top mouthpiece, 300 mm high pressure hose with 4 jaw hydraulics cross mouthpiece

A09 Chip guard, piece



Item no.	Size	Contents of delivery
108500	80/85	piece
108501	100/110	piece
108502	125	piece
108503	140/160	piece
108504	200	piece
108505	250	piece
108506	315/350/400	piece

C15 Scroll



Item no.	Size
102183	80/85
101754	100
101721	125
100303	160
100003	200
100203	250
101552	315

A09 Pinion holder screw



Item no.	Size
102185	85
100305	100/125/160
100006	200/250
101554	315

A09 Safety key with ejector



Item no.	Size	Square	Length mm
154370	80/85	6	110
154371	100/110	8	130
154372	125/140	9	130
154373	160	10	160
154374	200/230	11	160
154375	250/270	12	160
154376	315	14	200

Accessories ZS Hi-Tru

A09 Elongated safety key with ejector



Item no.	Size	Square	Length mm
154683	125/140	9	170
154685	160	10	180
154687	200/230	11	200
154689	250/270	12	200
154695	315	14	250

A26 Torque wrench



Item no.	Torque Nm	Length mm	Output	Working accuracy
10004116	20-120	435	12,7=1/2"	3%
10004117	60-320	659	12,7=1/2"	3%

A09 Safety adapter with ejector
For actuating the chuck with torque (defined torque introduction)



Item no.	Size	Square	Inch
178566	80/85	6	3/8
178567	100/110	8	1/2
178568	125/140	9	1/2
178569	160	10	1/2
178570	200/230	11	1/2
178571	250/270	12	1/2
178572	315/350	14	1/2

A26 Mounting screws
For cylindrical centre rim



Item no.	Size	Thread	Contents of delivery
249299	74-85	M6x20	piece
334571	100-140	M8x30	piece
249301	160-230	M10x35	piece
233025	250-270	M12x40	piece
220565	315-350	M16x50	piece

Jaw dimensions DURO-M, ZS Hi-Tru

Outward stepped jaw (inside jaw) **BB**

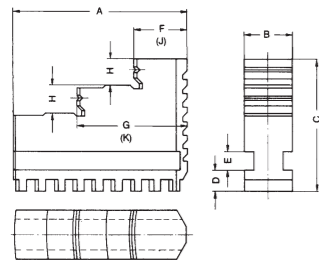

Unstepped jaw, soft (block jaw) **BL**

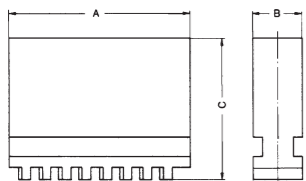

Dimensions F and G apply to outward stepped jaws **BB**
Dimensions J and K apply to inward stepped jaws **DB**

Size	74 ¹⁾	80/85	100/110	125	140	160	200	250	315	350/400	500/630
A	32	37	48	52	61	61	69	90	130	130	190
B	10	12	14	18	18	18	20	24	34	34	42
C	23	26	33,5	41,5	41,5	47,5	53,5	67,5	79,5	79,5	95
D	4,7	4,8	6,3	7,3	8,3	8,3	8,3	10,3	11,3	11,3	14,9
E	4	4,5	6	7	7	7	8	10	15	15	15
F	10	12	15	17	18	18	20	27	41,5	41,5	50
G	21	24,5	31	35	40	40	44	57	86,5	86,5	120
H	5	6	6	8	8	10	10	14	15	15	20
J	-	12	14	16	17	17	19	26	40	40	50
K	-	24,5	30	34	39	39	43	56	85	85	120
Jaw approx. kg	BB	0,03	0,05	0,1	0,2	0,22	0,25	0,3	0,7	1,8	3,8
	BL	0,05	0,08	0,15	0,27	0,32	0,38	0,52	1	2,4	5,2

1) Reversible jaws

Base jaw **GB**

Ø 100-400

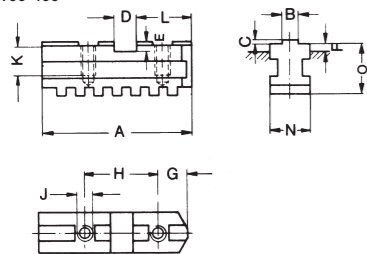

Ø 500-630

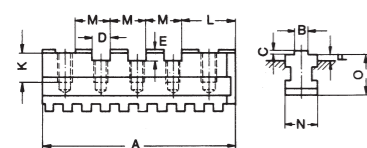

Ø 700-1250

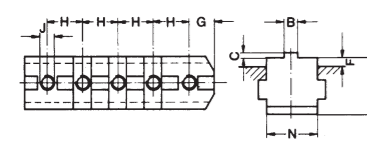

Size	100/110	125	140	160	200	250	315	350/400	500	630
A	46	55	65	65	78	92	108	127	165	203
B _{0,05}	7,94	7,94	7,94	7,94	7,94	12,7	12,7	12,7	12,7	12,7
C	2,5	3,1	3,1	3,1	3,1	3,1	3,1	3,1	3,1	3,1
D ^{+0,01}	9,5	12,68	12,68	12,68	12,68	19,03	19,03	19,03	19,03	19,03
E	6	7,6	7,6	7,6	7,6	7,6	7,6	10,8	10,8	10,8
F	3,4	4,8	7,8	4,8	6,8	8	5,5	10,5 ²⁾	8,5	8,5
G	12	13	15,8	15,8	19	22,2	25,4	28,5	28,5	28,5
H	24	32	38,1	38,1	44,45	54	63,5	76,2	38,1	38,1
J	metr. M6	M8	M8	M8	M8	M12	M12	M16	M20	M20
	UNC 1/4"-20	5/16"-18	3/8"-16	3/8"-16	3/8"-16	1/2"-13	1/2"-13	5/8"-11	3/4"-10	3/4"-10
K	12	14,5	16	16	16	20	25	29	33	33
L	19,25	22,6	28,5	28,5	34,9	39,7	47,6	57,1	57,1	57,1
M	-	-	-	-	-	-	-	-	38,1	38,1
N	14	18	18	18	20	24	34	34	42	42
O	19,5	24	27	27	28	35	40	45	49	49
Grooves	1	1	1	1	1	1	1	1	2	3
Tapped holes	2	2	2	2	2	2	2	2	4	5
Jaw approx. kg	0,06	0,12	0,17	0,17	0,22	0,4	0,78	1	1,72	2,1

Size	700	800	1000	1250
A	253	291	329	367
B _{0,05}	12,7	12,7	12,7	12,7
C	3,1	3,1	3,1	3,1
D ^{+0,01}	19,03	19,03	19,03	19,03
E	10,8	10,8	10,8	10,8
F	11	11	9	9
G	28,5	28,5	28,5	28,5
H	38,1	38,1	38,1	38,1
J	metr. M20	M20	M20	M20
	UNC 3/4"-10	3/4"-10	3/4"-10	3/4"-10
K	37	37	37	37
L	57,1	57,1	57,1	57,1
M	38,1	38,1	38,1	38,1
N	55	55	55	55
O	62	62	62	62
Grooves	4	5	6	7
Tapped holes	6	7	8	9
Jaw approx. kg	6,2	7,1	8	9

1) Reversible jaws

2) Size

Jaw dimensions DURO-M, ZS Hi-Tru

Reversible top jaw **UB**

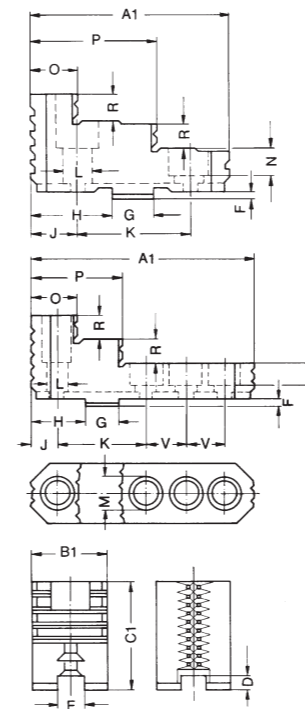

Saw-tooth standard model

Cross-grooving from size 250 available from size 700 standard-model

Unstepped top jaw soft **AB**

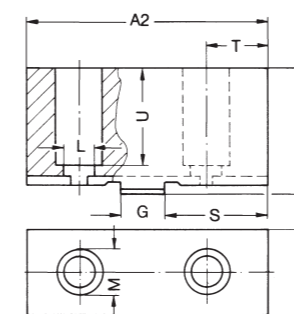

Special-design jaws

For non-rotating clamping devices, for symmetrical components, for machine vices and NC-compact vices available in all desired modifications.

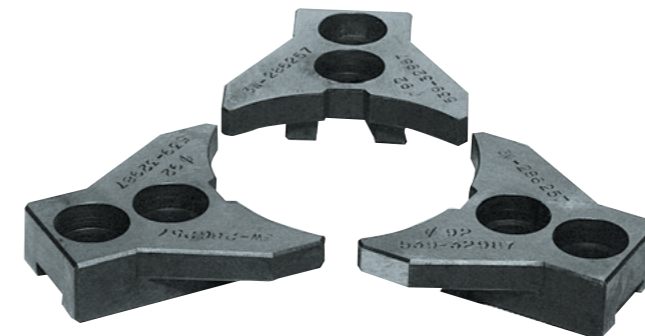

Chuck Size		100 110	125	140 160	200 230	250 270	315	350 400	500 630	700 800	1000 1250
A	1	47	56	66,7	79,5	95,3	109,5	127	127	210	210
	2	53	62	74	87	103	120	137	140	210	210
B	1	22	26	28	30	36	42	42	50	68	68
	2	22,5	26,5	28,5	30,5	36,5	42,5	42,5	50,5	68	68
C	1	29,5	37,5	41,5	42,5	52,5	57,5	64,5	79,5	89	110
	2	30	38	42	43	53	58	65	80	89	110
D		5,5	7,6	7,6	7,6	7,6	7,6	10,8	10,8	10,8	10,8
E		7,96	7,96	7,96	7,96	12,72	12,72	12,72	12,72	12,72	12,72
F		2,5	3,1	3,1	3,1	3,1	3,1	6,35	6,35	6,35	6,35
G		9,50	12,68	12,68	12,68	19,03	19,03	19,03	19,03	19,03	19,03
H		19,25	22,6	28,5	34,9	39,7	47,6	57,1	57,1	57,1	57,1
J		12	13	15,8	19	22,2	25,4	28,5	28,5	28,5	28,5
K		24	32	38,1	44,45	53,95	63,5	76,2	76,2	76,2	76,2
L		6,6	9	9 ¹⁾ 10,5 ²⁾	9 ¹⁾ 10,5 ²⁾	14	14	18	22	22	22
M		11	15	15 ¹⁾ 16 ²⁾	15 ¹⁾ 16 ²⁾	20	20	26	33	33	33
N		7	9	10	10	13,5	13,5	17	21	21,5	21,5
O		12	13	15,8	19	22,2	25,4	28,5	54,6	51	51
P		29,5	35	42,8	51,5	60,2	67,4	77	88,5	89	89
R		6	8	10	10	14	15	15	20	22	25
S		22,25	25,6	32,2	38,7	43,5	52,9	62,1	63,6	70	70
T		15	16	19,5	22,8	26	30,7	33,55	35	41,5	41,5
U		19	27	30	30	41	43	47	61	65	71
V		-	-	-	-	-	-	-	-	38,1	38,1
Jaw approx. kg	UB	0,12	0,19	0,27	0,39	0,66	1,02	1,27	2	4,45	6,1
	AB	0,21	0,34	0,5	0,7	1,2	1,86	2,18	3,04	8	10,8

Notes

This chuck is used for aligning irregularly shaped workpieces.

Principle of operation

Through a radially arranged drive (1, hardened), the force is transferred via a bevel gearing to a hardened spiral ring (2) and further conducted via the spiral to the base jaws (3, hardened and ground), spindle (4, hardened) and reversible jaws (5, hardened and ground). The position of the workpiece can be adjusted by turning the spindle. Steel body (6), cover (7).

Clamping force transfer system

The jaws can be adjusted over the entire clamping range by turning the key.

Lubrication

To maintain the clamping force, geared scroll chucks must be lubricated regularly. You will find corresponding information in the operating instructions which are enclosed with every chuck. All geared scroll chucks are provided with grease nipples for easy maintenance.

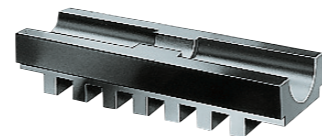
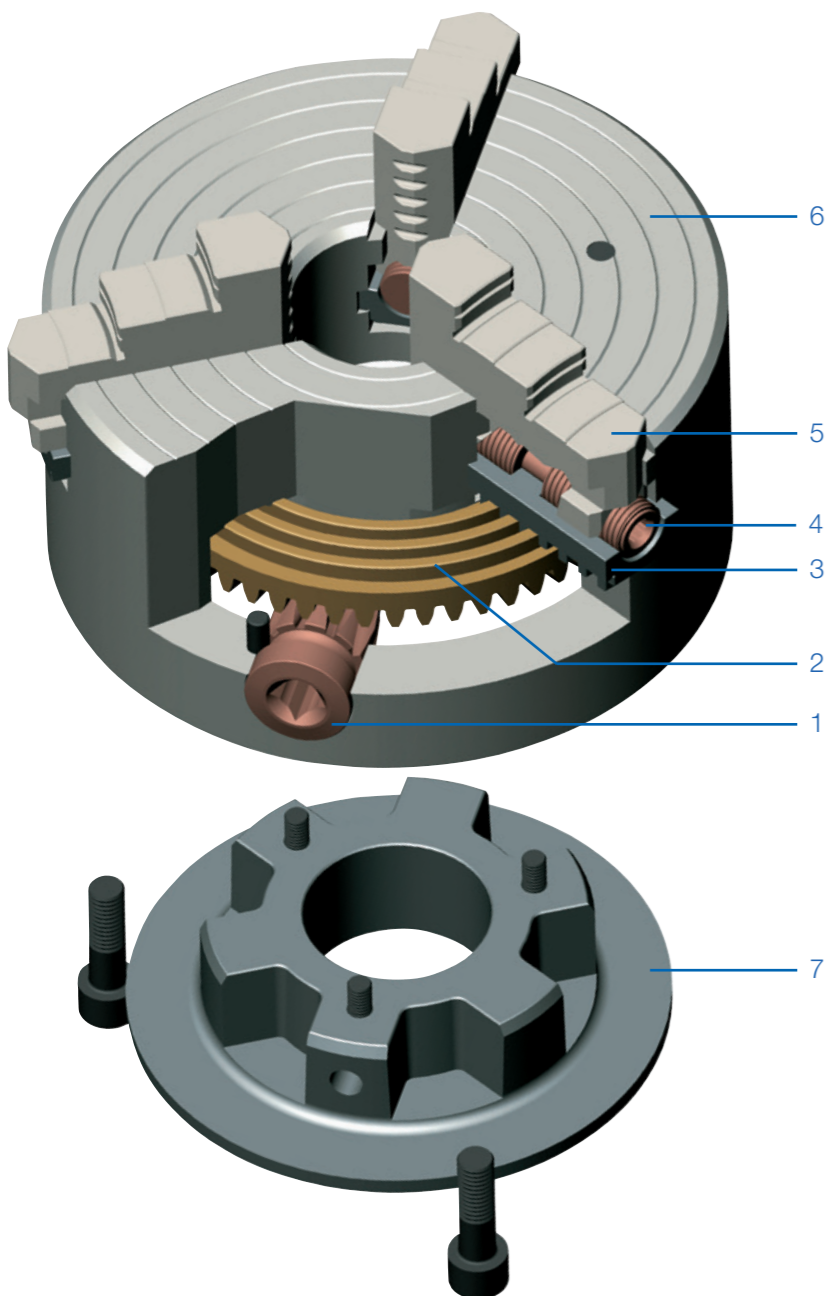

Base jaw GB, hardened and ground

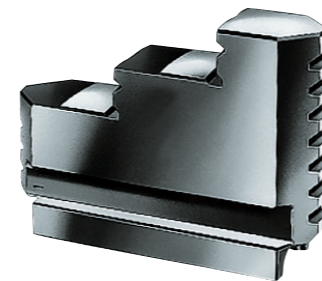

Reversible top jaw UB, hardened and ground



Unstepped jaw BL, unstepped, soft, material 16MnCr5

APPLICATION

Optimized for the machining of irregularly shaped workpieces.

TYPE

Geared scroll chuck in steel design with which irregularly shaped workpieces can be aligned via adjusting spindles. 3-jaw and 4-jaw version.

CUSTOMER BENEFITS

- ⊕ Exact alignment of irregularly shaped workpieces
- ⊕ Jaws centrally clamping and individually adjustable
- ⊕ Die-forged spiral ring, series-balanced and hardened
- ⊕ Jaws in chuck ground out for concentricity

TECHNICAL FEATURES

- With one set each of base and reversible jaws
- Clamping wrench
- Dimensions and mountings to DIN 6351
- Hardened spiral ring
- Die-forged steel body

ES = independently adjustable jaws, steel



A09
DIN 6351, cylindrical centre mount, form A

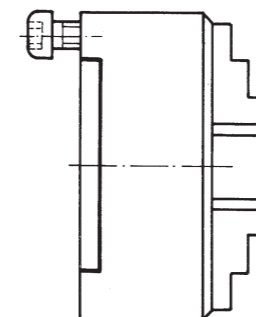

Size	ZA	Through-hole mm	3-jaw chuck steel	4-jaw chuck steel	Torque Nm	Total clamping force kN
160	125	42	111360	111789	110	47
200	160	55	111365	111793	140	55
250	200	76	111370	111797	150	63
315	260	103	111375	111801	180	69
400	330	136	111380	111805	240	92
500	420	190	111385	111809	260	100
630	545	240	111390	111813	280	105

Further sizes and mountings available on request

Jaws ES

A09 Reversible jaw UB, hardened, tongue and groove for external and internal clamping, material 16 MnCr5



Chuck Size	3-jaw set	4-jaw set	Jaw length mm	Jaw height mm	Jaw width mm
160	110118	110124	69	50	20
200	139666	139670	85	57,5	24
250	139667	139671	90	67,5	24
315/400	139668	139672	130	79,5	34
500/630	139669	139673	190	95	42

A09 Unstepped jaw BL, unstepped, soft



Chuck Size	3-jaw set	4-jaw set	Jaw length mm	Jaw height mm	Jaw width mm
160	107669	107675	69	50	20
200	139674	139678	85	57,5	24
250	139675	139679	90	67,5	24
315/400	139676	139680	130	79,5	34
500/630	139677	139681	190	95	42

A09 Base jaw GB, hardened, tongue and groove for external and internal clamping, material 16 MnCr5



Chuck Size	3-jaw set	4-jaw set	Jaw length mm	Jaw height mm	Jaw width mm
160	107654	107662	62	15,3	26
200	139682	139686	78	17,8	30
250	139683	139687	86	17,8	30
315	139684	139688	118	22,7	44
400	139685	139689	118	22,7	44
500/630	107659	107667	176	25	54

A09 Base plates for lathe chucks with cylindrical centre mount, DIN 6350

Item no.	Size	Thread
162793	160	6xM10
162401	200	6xM10
163036	250	
133705	315	



Accessories ES

A09 Base plates for lathe chucks with cylindrical centre mount, DIN 63500

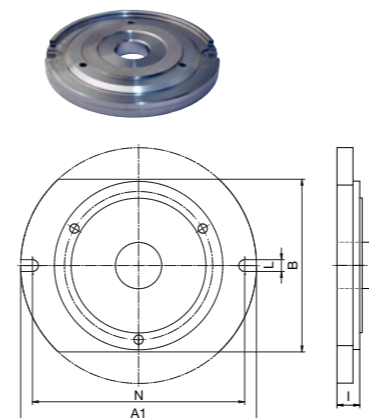

Item no.	Size	A1 mm	B mm	L mm	N mm	E mm	I mm
162793	160	240	-	14	212	42	27
162401	200	280	-	14	252	55	27
163036	250	330	-	18	303	76	27
133705	315	386	320	18	354	103	27
133706	400	470	405	18	438	136	27

A09 Adjusting spindle

Item no.	For chuck size
104251	125
104271	160
137735	200
137643	250
137701	400/315
137716	500

A09 Scroll

Item no.	Size
101721	125
100303	160
100003	200
100203	250
101552	315
102497	400
162973	500
162964	630

A09 Pinion holder screw

Item no.	Size
100305	160
100006	270
101554	315
102499	400
103300	630

C15 Grease gun DIN1283

Item no.	Connec-tion	Contents of delivery
329093	M10x1	150 mm nozzle tube bent, needlepoint mouthpiece, top mouthpiece, 300 mm high pressure hose with 4 jaw hydraulics cross mouthpiece

A09 Special grease F80 for lathe chucks
For lubrication and conservation of chucking power

Item no.	Design	Contents
308555	Cartridge (DIN 1284) Ø 53.5x235mm	0,5 kg
028975	Tin	1 kg

A09 Adjusting key

Item no.	For chuck size	Square	Hexagon
107444	125/160	5,5	-
139695	200/250/315/400	-	8
139696	500/630	-	12

A09 Driving pinion

Item no.	Size	Square
100304	160	10
100005	200	11
100204	250	12
112267	270	12
101553	315	14
105229	350	14
102498	400	17
162974	500	19
162965	630	19

A09 Standard key

Item no.	Size	Square	Length mm
107427	100/110	8	75
107428	125/140	9	80
107429	160	10	90
107430	200/230	11	100
107431	250/270	12	100
107432	315	14	110
107433	350	14	140
107434	400	17	140
107435	500/630	19	150

Accessories ES

A09 Safety key with ejector

Item no.	Size	Square	Length mm
154371	100/110	8	130
154372	125/140	9	130
154373	160	10	160
154374	200/230	11	160
154375	250/270	12	160
154376	315	14	200
154377	350	14	200
154378	400	17	250
154379	500/630	19	250

A09 Elongated safety key with ejector

Item no.	Size	Square	Length mm
154683	125/140	9	170
154685	160	10	180
154687	200/230	11	200
154689	250/270	12	200
154695	315	14	250

A09 Torque wrench

Item no.	Torque Nm	Length mm	Output	Working accuracy
10004116	20-120	435	12,7=1/2"	3%
10004117	60-320	659	12,7=1/2"	3%

A09 Safety adapter with ejector

For actuating the chuck with torque (defined torque introduction)

Item no.	Size	Square	Inch
178566	80/85	6	3/8
178567	100/110	8	1/2
178568	125/140	9	1/2
178569	160	10	1/2
178570	200/230	11	1/2
178571	250/270	12	1/2
178572	315/350	14	1/2

C15 Set screw with nut, DIN 55021

Item no.	Thread	For taper	Quantity
107453	M10x30	4	3
107455	M10x35	5	4
107456	M12x40	6	4
107457	M16x45	8	4
107458	M20x55	11	6
127618	M24x65	15	6

C15 Mounting screws

For lathe chucks with direct short-taper, for front mounting

Item no.	Size	Thread	Contents of delivery	Chuck Size	Taper size
233059	74	M10x70	piece	160	5
308436	80	M10x85	piece	200	5
200186	85	M12x85	piece	200	6
234615	100	M10x110	piece	250	5
302215	110	M12x90	piece	250	6
202439	125	M16x90	piece	250	8
316244	140	M12x120	piece	315	6
308439	160	M16x105	piece	315	8
342701	315	M16x130	piece	400	8
698878	350	M20x115	piece	400	11
011528	400	M20x155	piece	500	11
358815	500	M20x170	piece	630	11
202509	630	M24x150	piece	630	15

A09 Stud and locknut ISO 702-3 (DIN 55027)

Item no.	Thread	Contents of delivery	For taper	Quantity
107447	M10x34	piece	3	3
107448	M10x39	piece	4	3
107449	M10x43	piece	5	4
107450	M12x50	piece	6	4
107451	M16x60	piece	8	4
107452	M20x75	piece	11	6
125650	M24x90	piece	15	6

A09 Stud for Camlock ASA B 5.9 (DIN 55029) and cylindrical studs

Item no.	Thread	For taper	Quantity
107465	7/16-20x35	3	3
107466	7/16-20x37	4	3
107467	1/2-20x43	5	6
107468	5/8-18x49	6	6
107469	3/4-16x55,5	8	6
107470	7/8-14x67	11	6
127621	1-14x76	15	6

A09 Stud for Camlock ISO 702-2 (DIN 55029) and cylindrical studs

Item no.	Thread	For taper	Quantity
178364	M10x1	3	3
178365	M10x1	4	3
178366	M12x1	5	6
178367	M16x1,5	6	6
178368	M20x1,5	8	6
178369	M22x1,5	11	6
178370	M24x1,5	15	6
178371	M27x2	20	6

Chuck dimensions ES

Cylindrical centre mount DIN 6351

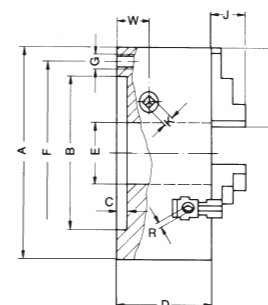

The bore (measure E) could be enlarged (at surcharge)
 Enlarged bore max.

Size A	100	125	160	200	250	315	400	500	630
BH6	70	95	125	160	200	260	330	420	545
C	3	4	4	4	5	5	5	5	7
D	67	71	80	95,5	100	117	123	145	160
E	20	32	42	55	76	103	136	190	240
E _{max.}	21	33	50	70	92	114	150	210	253
F	83	108	140	176	224	286	362	458	586
G	3xM8	3xM8	3xM10	3xM10	3xM12	3xM16	3xM16	6xM16	6xM16
H	56	56	69	85	90	130	130	190	190
J	22	21	28	32,5	40,6	46,5	47	55	55
K	8	9	10	11	12	14	17	19	19
R*	5,5	5,5	5,5	8	8	8	8	12	12
W	20	20	22,45	25,7	26,5	30	35	38	48
approx. kg	4	6	10	18	29	54	88	145	240

* from Ø 200 hexagon

Max. permissible speeds for chucks ES to DIN 6351

The specified values are only applicable for workpieces not exceeding a specific unbalance of 25 gmm/kg.

Size	3-Jaw Steel body	4-Jaw Steel body
100	-	-
125	-	-
160	3200	2850
200	2650	2350
250	2200	1900
315	1400	1220
400	1400	1220
500	880	770
630	750	660

Reversible jaw UB

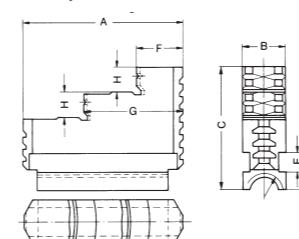

Left-hand thread

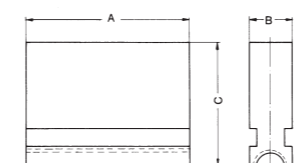

Size	100	125	160	200	250	315	400	500	630
A	56	56	69	85	90	130	130	190	190
B	18	18	20	24	24	34	34	42	42
C	41,5	41,5	50	57,5	67,5	79,5	79,5	95	95
D	8,7	8,7	9,7	9,7	9,7	11,15	11,15	15	15
E	7	7	8	10	10	15	15	15	15
F	17	17	19	25	26	40	40	50	50
G	35	35	43	54	56	85	85	120	120
H	8	8	10	12	14	15	15	20	20
Thread	Tr14x3	Tr14x3	Tr16x4	Tr18x2	Tr18x2	Tr20x2	Tr20x2	Tr26x3	Tr26x3
approx. kg	0,18	0,18	0,3	0,53	0,7	1,7	1,7	3,7	3,7

KRF - actuation by turning the clamping ring



APPLICATION

3- and 4-jaw chuck for positioning and conveying workpieces, e.g. on measuring machines.

TYPE

Lever scroll chuck in cast iron version.
3-jaw and 4-jaw version.

CUSTOMER BENEFITS

- ⊕ Easy clamping of the workpiece by turning the clamping ring
- ⊕ Sizes 125 - 200: incl. 4 setscrews for fine adjustment
- ⊕ Cast iron body
- ⊕ Jaws in chuck ground out for concentricity

TECHNICAL FEATURES

- 6 jaw chuck for grinding twist drills on request available

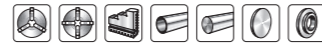

KRF - on base plate



APPLICATION

3-jaw chuck with base plate for positioning and conveying workpieces, e.g. on measuring machines.

TYPE

Lever scroll chuck in cast iron version.

CUSTOMER BENEFITS

- ⊕ Easy clamping of the workpiece by turning the clamping ring
- ⊕ Sizes 125 - 200: incl. 4 setscrews for fine adjustment
- ⊕ Cast iron body

TECHNICAL FEATURES

- Mounted in the chuck with one set of jaws stepped outward (BB)
- One set of jaws stepped inward (DB)
- Size 70 with reversible jaws
- Mounting screws



A09
Lever scroll chuck KRF, cylindrical centre mount

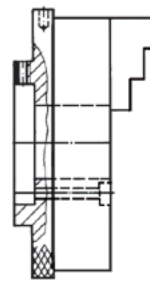

Size	ZA	Through-hole mm	3-jaw chuck with inside and outside jaw	4-jaw chuck with inside and outside jaw	Torque Nm	Total clamping force kN
70	48	16	148793 ¹⁾	148794	12	2,5
110	75	26	148757	148772	26	3,2
125	70	35	150757	150758	36	3,5
160	78,5	52	150759	150760	50	4
200	115	64	150761	150762	60	4,5

¹⁾ Jaws reversible
Sizes 125 - 200: 4 setscrews for fine adjustment
Further sizes and mountings available on request

Dimensions KRF, cylindrical centre mount

Size	A	B ^{H6}	C	D	F	3-jaws G	4-jaws G	H	J	K	M	Clamping range external	Clamping range internal	Weight ca. kg 3-jaws	Weight ca. kg 4-jaws
70	48	1,5	33	39	3xM6	3xM6	32	13,6	52	72	2-70	23-70	1	1,4	
110	75	2	38	62	3xM8	3xM8	48	19	85	112	3-110	33-104	3	3,4	
125	70	8	53	56	3xØ6,6	4xØ6,6	52	22,5	83	129	3-125	37-123	4	4,5	
160	78,5	8	52	65	3xØ6,6	4xØ6,6	61	26,6	96	164	3-160	39-152	7	7,5	
200	115	13	66	84	3xØ9	4xØ9	69	31	147	205	4-200	44-186	13	14	

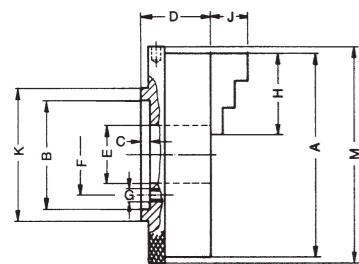

Size 70-100

4 setscrews for fine adjustment

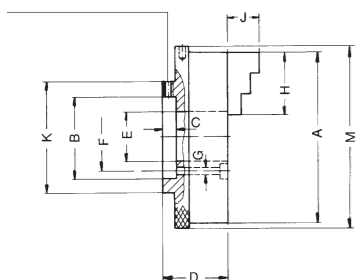

A09
Lever scroll chucks with base plate, 3-jaw-chuck cast iron body

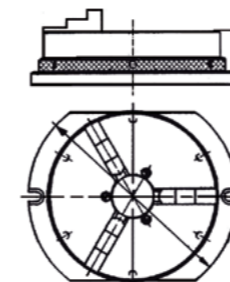

Item no.	Size	Through-hole mm	D mm	Torque Nm	Total clamping force kN
150595 ¹⁾	70	16	46,4	12	2,5
150596	110	26	50	26	3,2
150597	125	35	59	36	3,5
150598	160	52	59	50	4
150599	200	64	69	60	4,5

¹⁾ Jaws reversible
Further sizes and mountings available on request

Dimensions KRF, cylindrical centre mount

Size	A ₁	B	C	F	G	H	J	K	M	N	O	Clamping range external	Clamping range internal
70	100	70	87	72	32	5	13	21	9	6	60	2-70	23-70
110	140	110	126	112	48	6	13	23	9	8	67,5	3-110	33-104
125	170	125	154	129	52	8	14	32	11	8	81,5	3-125	37-123
160	200	160	184	164	61	10	15	31	11	8	85	3-160	39-152
200	250	200	230	205	69	10	15	39	11	8	100	4-200	44-186

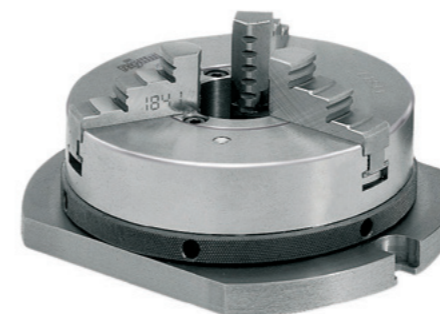
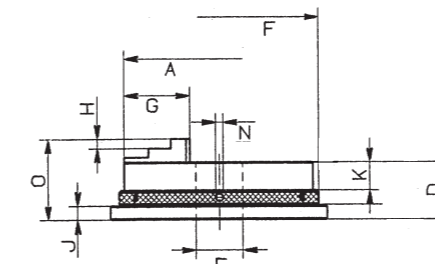

Jaws KRF

A09
Inside jaw BB, DIN 6350, outward stepped jaw, hardened



Chuck Size	3-jaw set	4-jaw set	Jaw length mm	Jaw height mm	Jaw width mm
70	110154 ¹⁾	149305	32	23	10
110	110156	110064	48	33,5	14
125	110157	110065	52	41,5	18
160	110159	110067	61	47,5	18
200	110160	110068	69	53,5	20

¹⁾ Reversible for use a turning or inside jaw
Additionally or later applied, hardened stepped jaws must be ground out in the chuck.
For jaws which are applied later, send in the chuck.

A09
Outside jaw DB, DIN 6350, inward stepped jaw, hardened



Chuck Size	3-jaw set	4-jaw set	Jaw length mm	Jaw height mm	Jaw width mm
70/110	110166	110074	48	33,5	14
125	110167	110075	52	41,5	18
160	110169	110077	61	47,5	18
200	110170	110078	69	53,5	20

Additionally or later applied, hardened stepped jaws must be ground out in the chuck.
For jaws which are applied later, send in the chuck.

A09
Unstepped jaw BL, DIN 6350, unstepped, soft, material 16MnCr5

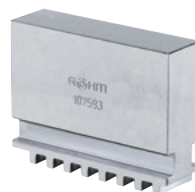

Chuck Size	3-jaw set	4-jaw set	Jaw length mm	Jaw height mm	Jaw width mm
70	109114 ¹⁾	149304 ¹⁾	32	23	10
110	107589	107599	48	33,5	14
125	107590	107600	52	41,5	18
160	107592	107602	61	47,5	18
200	107593	107603	69	53,5	20

¹⁾ Reversible

Accessories KRF

A09 Chip guard, piece



Item no.	Size	Contents of delivery
108501	100/110	piece
108502	125	piece
108503	140/160	piece
108504	200	piece

A09 Special grease F80 for lathe chucks
For lubrication and conservation of chucking power



Item no.	Design	Contents
308555	Cartridge (DIN 1284) Ø 53,5x235mm	0,5 kg
028975	Tin	1 kg

C15 Grease gun DIN1283

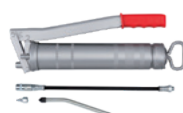

Item no.	Connec- tion	Contents of delivery
329093	M10x1	150 mm nozzle tube bent, needlepoint mouthpiece, top mouthpiece, 300 mm high pressure hose with 4 jaw hydraulics cross mouthpiece

Notes



APPLICATION

For turning out unhardened and grinding out hardened jaws. Adjusting jaws reversible and infinitely variably adjustable.

TYPE

Lightweight design.

CUSTOMER BENEFITS

- ⊕ Using the BAV, the chuck can be put into the status it assumes later during workpiece machining (preclamping) within a few seconds
- ⊕ The turned clamping surfaces of the chuck jaws are thus form-fit and exactly concentric in the clamped state
- ⊕ Bypassing a large clamping range

TECHNICAL FEATURES

- Only applicable with base jaws (GB) and top jaws (AB)

Adapter plates

A09

Short-taper adapter plate for ISO 702-1 (DIN 55026), finished on both sides

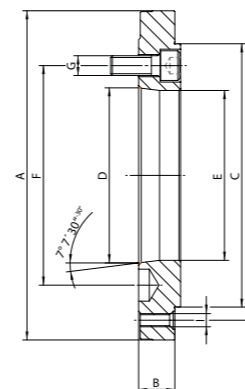

Item no.	Ø A mm	Taper	B mm	C mm	D mm	E mm	F mm	G	H mm	I	Weight approx. kg
182900	140	3	17	95	53,975	51,20	70,60	M10	108/120	3x/6x M8	1,4
182902	140	4	21	95	63,513	61,00	82,60	M10	108/120	3x/6x M8	1,55
182904	140	5	21	95	82,563	79,60	104,80	M10	108/120	3x/6x M8	1,4
182906	165	6	25	95	106,375	80,00	133,40	M12	108/120	6x M8	2,7
182908	160	4	18	125	63,513	61,00	82,60	M10	140	6x M10	2,5
182910	160	5	18	125	82,563	79,60	104,80	M10	140	6x M10	2,2
182912	165	6	25	125	106,375	103,20	133,40	M12	140	6x M10	2,5
182914	210	8	32	125	139,719	100,00	171,40	M16	140	6x M10	5,8
182916	200	4	18	160	63,513	61,00	82,60	M10	176	6x M10	5
182918	200	5	18	160	82,563	79,60	104,80	M10	176	6x M10	3,9
182920	200	6	22	160	106,375	103,20	133,40	M12	176	6x M10	4,1
182922	210	8	32	160	139,719	136,20	171,40	M16	176	6x M10	5
182924	250	5	21	200	82,563	79,00	104,80	M10	224	3x M12	7,7
182926	250	6	26	200	106,375	103,00	133,40	M12	224	3x M12	8,7
182928	250	8	30	200	139,719	136,20	171,40	M16	224	3x M12	7,3
182930	315	6	24	260	106,375	103,00	133,40	M12	286	3x M12	14,5
182932	315	8	30	260	139,719	136,00	171,40	M16	286	3x M12	16
182934	315	11	42	260	196,869	192,90	235,00	M20	286	3x M12	16,2
182936	400	6	32	330	106,375	103,00	133,40	M12	362	3x M16	30,8
182938	400	8	32	330	139,719	136,00	171,40	M16	362	3x M16	29
182940	400	11	38	330	196,869	192,90	235,00	M20	362	3x M16	29,7
182942	400	15	49	330	285,775	281,50	330,00	M24	362	3x M16	24,5
182944	500	8	36	420	139,719	136,20	171,40	M16	458	6x M16	53,1
182946	500	11	36	420	196,869	192,90	235,00	M20	458	6x M16	49
182948	500	15	46	420	285,775	281,50	330,00	M24	458	6x M16	49,5
182950	630	11	42	545	196,869	192,90	235,00	M20	586	6x M16	100
182952	630	15	43	545	285,775	281,50	330,00	M24	586	6x M16	90
182954	630	20	42	545	412,775	408,00	463,60	M24	586	6x M16	63

A09

Jaw cutting attachment for 3-jaw chucks

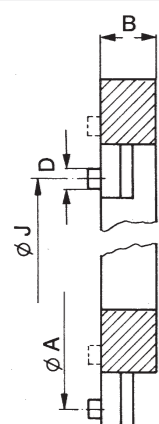

Item no.	Size	For chuck size	Clamping force max. kN	External Ø mm	Inner Ø mm	Overhang distance		B	Thread	Weight approx. kg
						Ø J	Ø A			
220206	0	125	15	153	110	50-115	150-215	20	M5	1,6
220207	1	200	30	176	110	35-125	170-260	31	M8	3,4
220208	2	250	30	215	135	70-140	215-285	31	M8	5
220209	3	250	30	244	162	100-175	240-315	31	M8	5,7
220210	4	315	30	290	208	145-215	290-360	31	M8	6,9
220211	5	400	40	342	260	160-270	330-440	31	M10	8,5



A09

Short-taper adapter plate ISO 702-2 (DIN 55029) and ASA B 5.9 D1, Camlock

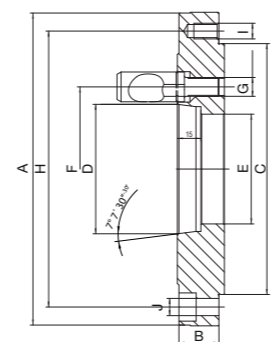

Item no.	Ø A mm	Taper	B mm	Ø C mm	Ø D mm	Ø E mm	Ø F mm	G	Ø H mm	I	Ø J mm	Weight approx. kg
182956	140	3	24,00	95	53,975	33,00	70,60	M10x1	108/120	6x M8	3x 9	2,1
182958	140	4	24,00	95	63,513	33,00	82,60	M10x1	108/120	6x M8	3x 9	2,1
182960	146	5	30,00	95	82,563	33,00	104,80	M12x1	108/120	6x M8	-	3,7
182962	181	6	36,00	95	106,375	33,00	133,40	M16x1,5	108/120	6x M8	-	6,7
182964	160	3	23,50	125	53,975	51,50	70,60	M10x1	140	6x M10	3x 11	3,4
182966	160	4	23,50	125	63,513	50,00	82,60	M10x1	140	6x M10	3x 11	3,4
182968	160	5	26,50	125	82,563	50,00	104,80	M12x1	140	6x M10	3x 11	3,9
182970	181	6	35,50	125	106,375	50,00	133,40	M16x1,5	140	6x M10	-	6,5
182972	225	8	38,50	125	139,719	50,00	171,40	M20x1,5	140	6x M10	-	10,7
182974	200	4	24,50	160	63,513	61,00	82,60	M10x1	176	6x M10	3x 11	5,7
182976	200	5	26,50	160	82,563	70,00	104,80	M12x1	176	6x M10	3x 11	6,1
182978	200	6	32,50	160	106,375	70,00	133,40	M16x1,5	176	6x M10	3x 11	7,3
182980	225	8	39,50	160	139,719	70,00	171,40	M20x1,5	176	6x M10	-	10,8
182982	250	4	24,00	200	63,513	61,00	82,60	M10x1	224	6x M12	3x 14	9,2
182984	250	5	27,00	200	82,563	79,60	104,80	M12x1	224	6x M12	3x 14	10
182986	250	6	32,00	200	106,375	92,00	133,40	M16x1,5	224	6x M12	3x 14	11,3
182988	250	8	35,00	200	139,719	92,00	171,40	M20x1,5	224	6x M12	3x 14	11,9
182990	315	5	31,50	260	82,563	79,60	104,80	M12x1	286	3x M12	3x 18	19,2
182992	315	6	31,50	260	106,375	103,20	133,40	M16x1,5	286	3x M12	3x 18	18,5
182994	315	8	34,50	260	139,719	114,00	171,40	M20x1,5	286	3x M12	3x 18	19,4
182996	315	11	40,50	260	196,869	114,00	235,00	M22x1,5	286	3x M12	3x 18	21,1
182998	400	6	31,50	330	106,375	103,20	133,40	M16x1,5	362	3x M12	3x 18	31
183000	400	8	34,50	330	139,719	136,20	171,40	M20x1,5	362	3x M12	3x 18	32,3
183002	400	11	40,50	330	196,869	150,00	235,00	M22x1,5	362	3x M12	3x 18	35,4
183004	400	15	50,50	330	285,775	150,00	330,20	M24x1,5	362	3x M12	3x 18	39,5
183006	500	8	34,50	420	139,719	136,20	171,40	M20x1,5	458	6x M16	6x 18	52,2
183008	500	11	40,50	420	196,869	192,90	235,00	M22x1,5	458	6x M16	6x 18	56,4
183010	500	15	45,50	420	285,775	210,00	330,20	M24x1,5	458	6x M16	6x 18	57,5

Further sizes and designs, such as ISO 702-1, available on request!

Adapter plates

A09

Short-taper adapter plate ISO 702-3 (DIN 55027) and 55022 with studs and locknuts

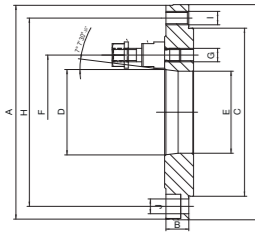

Item no.	Ø A mm	Taper	B mm	Ø C mm	Ø D mm	Ø E mm	Ø F mm	G	Ø H mm	I	Ø J mm	Weight approx. kg
183012	140	3	16,50	95	53,975	51,50	75,00	M10	108/120	6x M8	3x 9	1,5
183014	140	4	16,50	95	63,513	61,00	85,00	M10	108/120	6x M8	3x 9	1,4
183016	140	5	16,50	95	82,563	79,60	104,80	M10	108/120	6x M8	-	1,5
183018	170	6	27,00	95	106,375	80,00	133,40	M12	108/120	6x M8	-	3,7
183020	160	3	21,50	125	53,975	51,50	75,00	M10	140	6x M10	3x 11	3,25
183022	160	4	21,50	125	63,513	61,00	85,00	M10	140	6x M10	3x 11	3,1
183024	160	5	21,50	125	82,563	79,60	104,80	M10	140	6x M10	3x 11	2,8
183026	170	6	18,00	125	106,375	103,20	133,40	M12	140	6x M10	-	2,5
183028	220	8	31,50	125	139,719	100,00	171,40	M16	140	6x M10	-	7,25
183030	200	4	21,50	160	63,513	61,00	85,00	M10	176	6x M10	3x 11	5,1
183032	200	5	21,50	160	82,563	79,60	104,80	M10	176	6x M10	3x 11	4,8
183034	200	6	21,50	160	106,375	103,20	133,40	M12	176	6x M10	3x 11	4,4
183036	220	8	21,50	160	139,719	136,20	171,40	M16	176	6x M10	3x 11	4,7
183038	250	4	26,00	200	63,513	61,00	85,00	M10	224	3x M12	3x 14	9,9
183040	250	5	26,00	200	82,563	79,60	104,80	M10	224	3x M12	3x 14	9,5
183042	250	6	26,00	200	106,375	103,20	133,40	M12	224	3x M12	3x 14	8,9
183044	250	8	26,00	200	139,719	136,20	171,40	M16	224	3x M12	3x 14	8
183046	315	5	34,50	260	82,563	79,60	104,80	M10	286	3x M12	3x 18	20,7
183048	315	6	34,50	260	106,375	103,20	133,40	M12	286	3x M12	3x 18	19,8
183050	315	8	34,50	260	139,719	136,20	171,40	M16	286	3x M12	3x 18	18,4
183052	315	11	34,50	260	196,869	192,90	235,00	M20	286	3x M12	3x 18	15,7
183054	400	6	34,50	330	106,375	103,20	104,80	M12	362	3x M16	3x 18	33,3
183056	400	8	34,50	330	139,719	136,20	133,40	M16	362	3x M16	3x 18	32
183058	400	11	34,50	330	196,869	192,90	171,40	M20	362	3x M16	3x 18	29,2
183060	400	15	34,50	330	285,775	281,50	330,20	M24	362	3x M16	3x 18	21,4
183062	500	8	34,50	420	139,719	136,20	133,40	M16	458	6x M16	6x 18	52
183064	500	11	34,50	420	196,869	192,90	171,40	M20	458	6x M16	6x 18	49,3
183066	500	15	34,50	420	285,775	281,50	330,20	M24	458	6x M16	6x 18	41,5

Further sizes and designs, such as ISO 702-1, available on request!

Notes

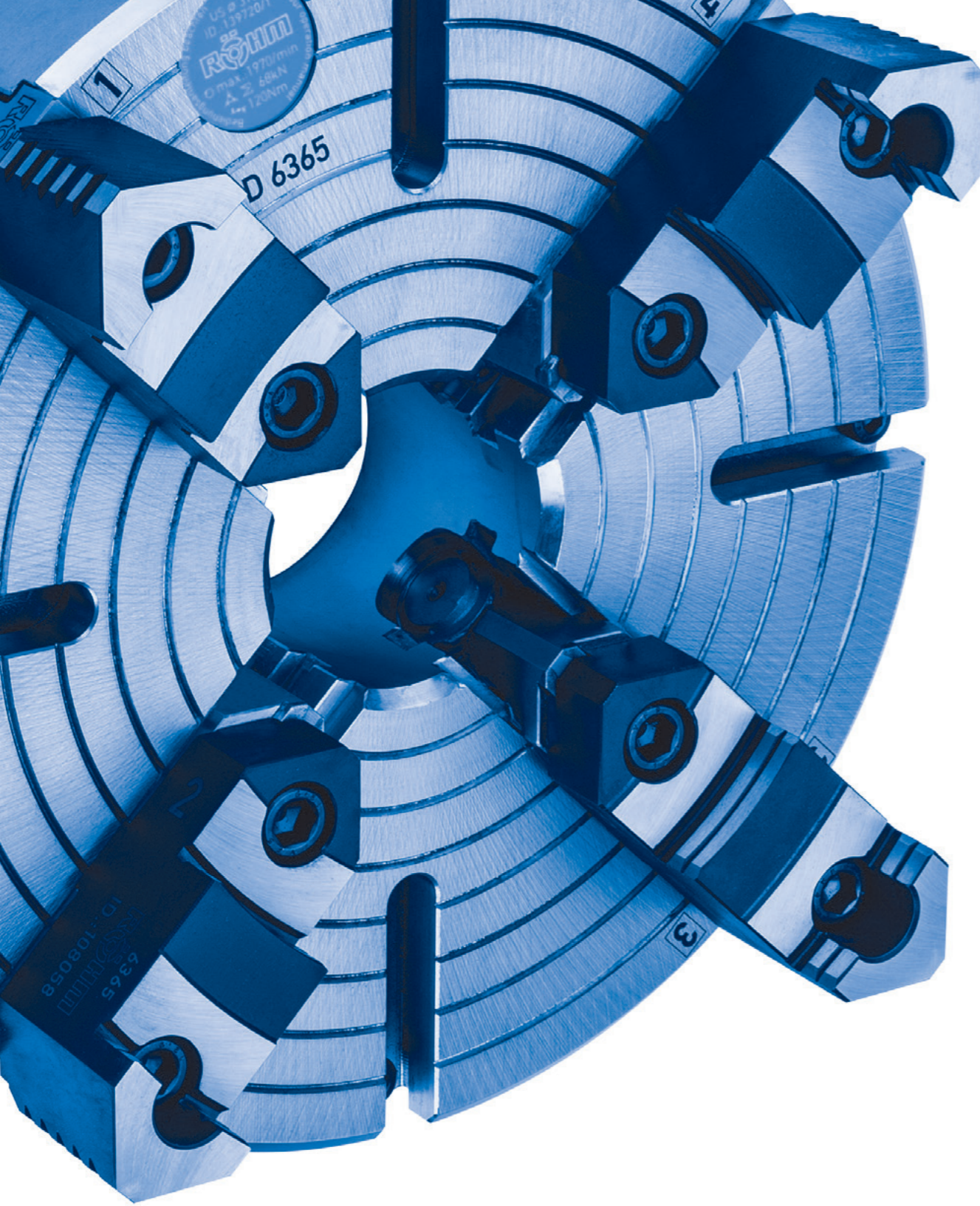

JAWS INDIVIDUALLY ADJUSTABLE

The four jaws can be independently adjusted via the threaded spindle, thereby allowing the safe and secure clamping of irregular, regular, as well as round workpieces.



INDEPENDENT CHUCKS

Independent chucks from RÖHM are particularly successful and effective when force has top priority. Due to the increased rigidity and optimal wear behavior, they are especially suitable for the initial machining of irregular, regular and round workpieces and make high machining forces and a longer machine service life possible.

ADVANTAGES AT A GLANCE

- ⊕ Safe and easy clamping of irregular, regular, as well as round workpieces by four independently adjustable jaws
- ⊕ Easy rough centering by means of concentric rings on the chuck body
- ⊕ Direct force transfer through radially arranged threaded spindles

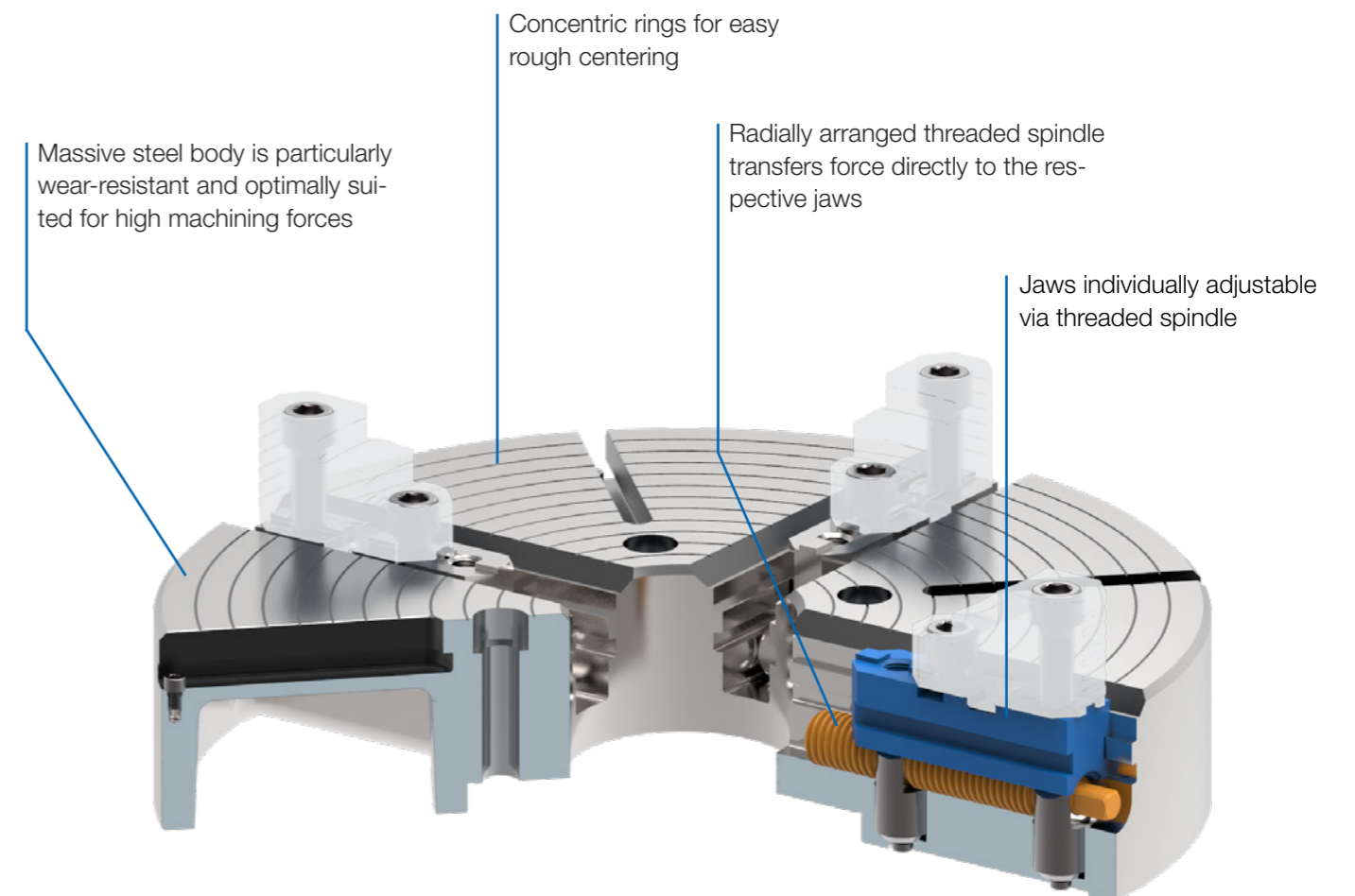

USE - USU - individually adjustable jaws



APPLICATION

Clamping chucks for lathes on which large, heavy or irregularly shaped workpieces are clamped.

TYPE

Independent 4-jaw chuck in steel design. Jaws individually adjustable via threaded spindle (no central drive). Starting from size 315 with T-slots. Starting from size 1100 with T-slots and set-up slots.

CUSTOMER BENEFITS

- Concentric rings for visual rough centering, fine centering using dial gauge

TECHNICAL FEATURES

- Steel design incl. clamping wrench and fastening screws, as well as 1 set of reversible or base and top jaws

USE = individually adjustable jaws, steel, one-piece jaws

USU = individually adjustable jaws, steel, reversible top jaws

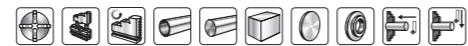

A26
Cylindrical centre mount (without mounting bolts)

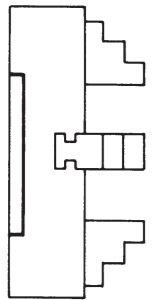

Size	With one-piece reversible jaws	With base jaws and top jaws	Through-hole mm	Speed max. min ⁻¹	Torque Nm	Clamping force/jaw kN
260	139781	137147	70	2350	120	17
310	139796	139720	75	1970	120	17
400	139827	135368	95	1530	170	23
450	139842	136944	95	1360	170	23
500	139857	135631	95	1220	170	23
630	139887	139723	135	970	240	37
710	140800	141097	135	860	240	37
800	140801	141106	190	765	300	45

Further sizes and mountings available on request

A26
ISO 702-3 (DIN 55027), DIN 55022, with studs and locknuts, optional DIN 55021 with set screw and nut

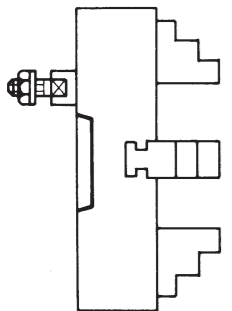

Size	Mount short taper	With one-piece reversible jaws	With base jaws and top jaws	Through-hole mm	Speed max. min ⁻¹	Torque Nm	Clamping force/jaw kN
260	4	139782	137163	61	2350	120	17
260	5	139783	137164	70	2350	120	17
260	6	139784	137165	70	2350	120	17
310	5	139797	139724	75	1970	120	17
310	6	139798	139725	75	1970	120	17
310	8	139799	139726	75	1970	120	17
400	6	139828	135371	95	1530	170	23
400	8	139829	135372	95	1530	170	23
400	11	139830	135358	95	1530	170	23
450	6	139843	136947	95	1360	170	23
450	8	139844	136948	95	1360	170	23
450	11	139845	136957	95	1360	170	23
500	6	139858	135632	95	1220	170	23
500	8	139859	135633	95	1220	170	23
500	11	139860	135696	95	1220	170	23
630	8	139888	139767	136	970	240	37
630	11	139889	139768	136	970	240	37
630	15	139890	139769	136	970	240	37
710	8	141088	141098	136	860	240	37
710	11	141089	141099	136	860	240	37
800	8	141092	600638	200	765	300	45
800	11	141093	141107	192	765	300	45

Further sizes and mountings available on request

USE - USU - individually adjustable jaws

Size	Mount short taper	With one-piece reversible jaws	With base jaws and top jaws	Through-hole mm	Speed max. min ⁻¹	Torque Nm	Clamping force/jaw kN
800	15	141094	141108	192	765	300	45
900	11	-	600639	190	680	300	45
900	15	-	600641	190	680	300	45
1000	11	-	141115	190	610	320	47
1000	15	-	141116	190	610	320	47
1000	20	-	600645	190	610	320	47
1100	11	-	150500	190	555	320	47
1100	15	-	600642	190	555	320	47
1100	20	-	600646	190	555	320	47
1200	11	-	150501	190	510	450	64
1200	15	-	600643	190	510	450	64
1200	20	-	600647	190	510	450	64

Further sizes and mountings available on request

A26
ISO 702-2 (DIN 55029), ASA B 5.9, type D, with studs for Camlock

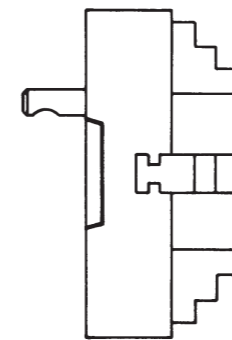

Size	Mount short taper	With one-piece reversible jaws	With base jaws and top jaws	Through-hole mm	Speed max. min ⁻¹	Torque Nm	Clamping force/jaw kN
260	4	139791	137166	60	2350	120	17
260	5	139792	137254	70	2350	120	17
260	6	139793	137255	70	2350	120	17
310	5	139806	139733	75	1970	120	17
310	6	139807	139734	75	1970	120	17
310	8	139808	139735	75	1970	120	17
400	6	139837	135375	95	1530	170	23
400	8	139838	135376	95	1530	170	23
400	11	139839	135359	95	1530	170	23
450	6	139852	136951	95	1360	170	23
450	8	139853	136952	95	1360	170	23
450	11	139854	136955	95	1360	170	23
500	6	139867	135703	95	1220	170	23
500	8	139868	135704	95	1220	170	23
500	11	139869	135705	95	1220	170	23
630	8	139897	139776	136	970	240	37
630	11	139898	139777	136	970	240	37
630	15	139899	139778	136	970	240	37
710	8	140804	141102	136	860	240	37
710	11	140805	141103	136	860	240	37
710	15	-	141418	136	860	240	37
800	11	140810	141418	192	765	300	45
800	15	140811	141112	192	765	300	45
900	11	-	600660	190	680	300	45
900	15	-	600661	190	680	300	45
1000	11	-	141119	190	610	320	47
1000	15	-	141120	190	610	320	47
1000	20	-	600665	190	610	320	47
1100	11	-	150504	190	555	320	47
1100	15	-	600662	190	555	320	47
1100	20	-	600666	190	555	320	47
1200	11	-	150505	190	510	450	64
1200	15	-	600663	190	510	450	64
1200	20	-	600667	190	510	450	64

Further sizes and mountings available on request

Jaws USE - USU

A09
Reversible jaw EB, 4-jaw set, hardened tongue and groove for external and internal clamping, material 16 MnCr5



Item no.	Chuck Size	Contents of delivery	Jaw length mm	Jaw height mm	Jaw width mm
022985	260	set	85	64	35
022986	310	set	94	66	35
163108	400/450	set	112	80	40
163109	500	set	136	88	40
175358	630/710	set	172	108	45
247823	800	set	185	130	60

A09
Base jaw GB, 4-jaw set, with fixing screw



Item no.	Chuck Size	Contents of delivery	Jaw length mm	Jaw height mm	Jaw width mm
304656	260	set	91	40,1	35
304657	310	set	107	40,1	35
304658	400/450	set	126	47,1	40
304659	500	set	164,4	47,1	40
304660	630	set	165	51,1	45
304661	710	set	202	51,1	45
304662	800/900/1000/1100	set	240	61,1	60
150543	1200	set	350	92,2	70

A09
Reversible top jaws UB DIN 6350, hardened, tongue and groove for external and internal clamping, material 16 MnCr5



Item no.	Chuck Size	Number of jaws	Contents of delivery	Jaw length mm	Jaw height mm	Jaw width mm
108057	260	4	set	95,3	52,5	36
108058	310	4	set	109,5	57,5	42
108059	400/450	4	set	127	64,5	42
108060	500/630/710	4	set	127	79,5	50
105085	800/900	4	set	210	89	68
105101	1000/1100/1200	4	set	210	110	68

Additionally or later applied, hardened stepped jaws must be ground out in the chuck.
For jaws which are applied later, send in the chuck.

A09
Unstepped top jaw AB DIN 6350, 4-jaw set, soft, material 16MnCr5



Item no.	Chuck Size	Number of jaws	Contents of delivery	Jaw length mm	Jaw height mm	Jaw width mm
107579	260	4	set	103	53	36,5
107580	310	4	set	120	58	42,5
107581	400/450	4	set	137	65	42,5
107582	500/630/710	4	set	140	80	50,5
105105	800/900	4	set	210	89	68
105109	1000/1100/1200	4	set	210	110	68

Accessories USE - USU

A26
Adjusting spindle



Item no.	Size	Square	Hexagon
169142	260	10	-
166565	310	10	-
162110	400	13	-
162121	450	13	-
161629	500	13	-
161611	630	16	-
161583	710	16	-
247826	800	18	-
150544	900	18	-
150545	1000	18	-
150546	1100	18	-
149776	1200	-	24

A26
Safety key



Item no.	Size	Square	Hexagon
160096	260/310	10	-
160097	400	13	-
160098	450/500	13	-
160099	630/710	16	-
160100	800/900/1000/1100	18	-
150548	1200	-	24

Chuck dimensions USE - USU

Cylindrical centre mount

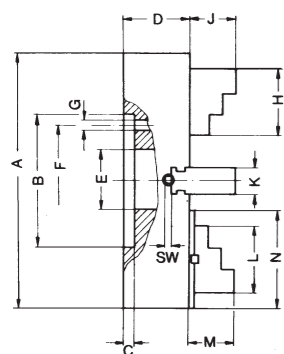

Size A	260	310	400	450	500	630	710	800
B ^{H8}	130	130	210	210	210	260	260	370
C	8	8	18	18	18	18	18	18
D USE - USU	85	95	112,5	112,5	112,5	122,5	132,5	145
E USE - USU	70	75	95	95	95	135	135	180
F	105	105	175	175	175	220	220	330
G	4x13,5	4x13,5	4x17	4x17	4x17	4x20,5	4x20,5	8x22
H	85	94	112	112	136	172	172	185
J	34	35	41,5	42	50	55,5	55,5	80
K	35	35	40	40	40	45	45	60
L	80	87	105	114	126	140	165	210
M	56,5	60,5	54	54	69	69	69	91
N	100	105	125	135	145	165	185	240
SW	10	10	13	13	13	16	16	18
approx. kg	23	32	52	76	91	150	190	270

1) Outer hexagon

Short taper mount

DIN 55021 with setscrews and locknuts



Size A	260			310			400			450			500			630			
Taper size	4 ¹⁾	5 ²⁾	6	5	6	8	6	8	11	6	8	11	6	8	11	8	11	15	
B	63,5	82,5	106,4	82,5	106,4	139,7	106,4	139,7	196,9	106,4	139,7	196,9	106,4	139,7	196,9	139,7	196,9	285,8	
D	75			82			112,5			112,5			112,5			122,5			
E	61	70	70	75			95			95			135						
F	DIN Camlock	85	104,8	133,4	104,8	133,4	171,4	133,4	171,4	235	133,4	171,4	235	133,4	171,4	235	171,4	235	330,2
G	11	11	14	11	14	18	14	18	22	14	18	22	14	18	22	18	22	26	
H	85			94			112			112			136			172			
J	34			35			42			42			50			55,5			
K	USE	35			35			40			40			40			45		
	USU	36			42			42			50			50					
L	95,3			109,5			127			127			127			127			
M	56,5			60,5			54			54			69			69			
N	91			107			126			126			164,4			165			
SW	10			10			13			13			13			16			
approx. kg	23			32			52			76			91			150			

Size A	710			800			
Taper size	8	11	15	8	11	15	
B	139,7	196,9	285,8	139,7	196,9	285,8	
D	132,5			145			
E	135			180			
F	171,4	235	330,2	171,4	235	330,2	
G	18	22	26	18	22	16	
H	172			185			
J	55,5			80			
K	USE	45			60		
	USU	68			68		
L	210			210			
M	69			91			
N	202			240			
SW	16			18			
approx. kg	190			270			

DIN 55029 with studs for camlock

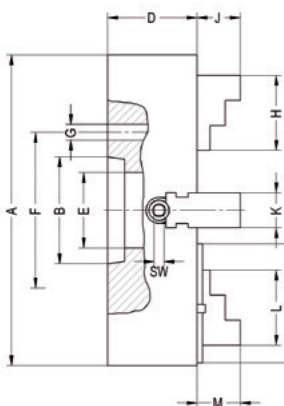

DIN 55026 mounting from front
1) Not for DIN 55021 or A1/A2 inch
2) Not for A1/A2 inch

Jaw dimensions USE - USU

Reversible one-piece jaw EB

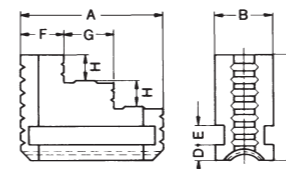

Size	260	310	400	450	500	630	710	800
A	85	94	112		136		172	185
B	35	35	40		40		45	60
C	64	66	80		88		108	130
D	10	10	10		10		12	14
E	12	12	14		14		14	18
F	27	30	36		42		52	55
G	29	32	38		46		60	65
H	14	15	19		23		26	30
approx. kg	0,8	0,9	1,6		2,25		3,5	4,2

Base jaw GB

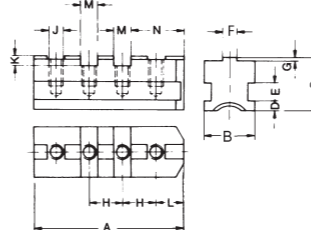

Size	260	310	400	450	630	710	800
A	91	107		126		165	240
B	35	35		40		45	60
C	40,1	40,1		47,1		51,1	61,1
D	10	10		10		12	14
E	12	12		14		14	18
F	12,7	12,7		12,7		12,7	12,7
G	3,1	3,1		3,1		3,1	3,1
H	54	63,5		76,2		38,1	38,1
J	M12	M12		M16		M20	M20
K	7,6	7,6		10,8		10,8	10,8
L	21,2	24,4		27,5		27,5	27,5
M	19,03	19,03		19,03		19,03	19,03
N	38,7	46,6		56,1		56,1	56,1
Grooves	1	1		1		2	4
Tapped holes	2	2		2		4	5
approx. kg	0,8	0,9		1,1		1,4	2,8

Reversible top jaw UB and unstepped top jaw

Adjusting spindle

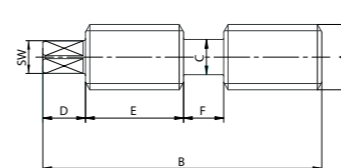

Size	260	310	400	450	500	630	710	800	900	1000	1100	1200
A	26	26	30	30	30	34	34	40	40	40	40	48
B	92	111	145	170	170	215	255	260	310	343	393	425
C	14	14	16	16	16	20	20	22	22	22	22	28
D	14	17	38	38	41	48	48	48	48	48	48	65
E	27,5	39	55	70	62	95	105	127	177	201	251	210
F	16	16	20	20	20	20	24	24	24	24	24	30
SW	10	10	13	13	13	16	16	18	18	18	18	24 ¹⁾

¹⁾With outer hexagon

Chucking capacities of jaw steps (standard values)

Size mm	260	310	400	450	500	630	710	800
A1 min.	20	20	35	40	40	60	130	190
A2 max.	260	295	400	450	500	585	690	800
I1 min.	75	80	90	100	145	145	245	170
I2 max.	260	310	360	450	520	650	730	820
max. swing. dia.	305	355	465	510	610	675	785	870

F-SENSO 2 Force measurement systems

APPLICATION

The F-SENSO 2 is a modular system for measuring the clamping or pull-in force before and/or after machining. It is used in the workshop, in manufacturing plants or in laboratories for checking after maintenance/service/repair, adjusting processes as well as managing the clamping device condition on machines.

TYPE

The F-SENSO 2 consists of a Senso module and a measuring head that varies depending on the application.
F-SENSO 2 module chuck: for measuring the clamping force in lathe chucks (hand and power operated) as well as vices.
F-SENSO 2 module HSK: for measuring the pull-in force of HSK clamping sets.

CUSTOMER BENEFITS

- ② Modular system, one F-SENSO 2 module for all measuring heads
- ② Measurement static or at speed
- ② Wireless transmission of measurement data and display of measurement results on the supplied tablet PC

SCOPE OF DELIVERY:

- Senso module, power supply unit for Senso module and USB cable
- F-SENSO 2 modules (depending on version)
- Tablet PC with keyboard, power supply unit
- Magnet for speed measurement
- Mounting key
- Large hard-shell case with foam inserts, small case with foam inserts for accessories



One Senso module for all measuring tasks

The F-SENSO 2 has a modular design. The Senso module contains all the electronic components for data processing and wireless data transmission. This means that the Senso module can be used for all measuring tasks. You only require one Senso module and the appropriate measuring head for the relevant task.



The F-SENSO 2 HSK module is simply screwed onto the Senso module



The F-SENSO 2 chuck module is simply screwed onto the Senso module



To measure the clamping force in clamping sets with hollow shaft cones, the F-SENSO 2 HSK module is available in four different sizes.



To measure the clamping force in manually or automatically clamping lathe chucks and vices, the F-SENSO 2 chuck module is available in three different sizes.

F-SENSO 2 Force measurement systems



F-SENSO 2 Chuck

Size	32	65
Clamping diameter	32	65
Measuring range, 3 measuring points kN	0-140	0-225
Measuring range, 2 measuring points kN	0-90	0-150
Max. speed rpm	8.000	6.000

Complete set - F-SENSO 2 Chuck

Id.-No.	10016792	10016793
Large, sturdy hard-shell case with foam insert	x	x
Senso module, including charger	x	x
F-SENSO 2 chuck module with measuring segments for 2 and 3 jaw measurement	32	65
Screws, mounting key	x	x
Tablet PC with Windows 10 and measurement software pre-installed	x	x
Speed sensor	x	x
Service pass	x	x

Supplementary set - F-SENSO 2 Chuck

Id.-No.	10016798	10016799
Sturdy hard-shell case with foam insert	x	x
F-SENSO 2 chuck module with measuring segments for 2 and 3 jaw measurement	32	65
Service pass	x	x



F-SENSO 2 HSK

Size	HSK 40	HSK 50	HSK 63	HSK 100
Measuring range, axial kN	0-20	0-20	0-50	0-90

Complete set - F-SENSO 2 HSK

Id.-No.	10016794	10016795	10016796	10016797
Large, sturdy hard-shell case with foam insert	x	x	x	x
Senso module, including charger	x	x	x	x
F-SENSO 2 HSK module	40	50	63	100
Screws, mounting key	x	x	x	x
Tablet PC with Windows 10 and measurement software pre-installed	x	x	x	x
Speed sensor	x	x	x	x
Service pass	x	x	x	x

Supplementary set - F-SENSO 2 HSK

Id.-No.	10016800	10016801	10016802	10016803
Sturdy hard-shell case with foam insert	x	x	x	x
F-SENSO 2 HSK module	40	50	63	100
Service pass	x	x	x	x

Accessories

Measuring pins



Id.-No.	10016898	10016804	10016805	10016806	10016899	10016807	10016808	10016809	10016810
Diameter	32	32	42	52	65	65	80	100	120
F-SENSO 2 chuck 32 module	x	x	x	x	x				
F-SENSO 2 chuck 65 module						x	x	x	x
2-point clamping force measurement	x					x	x	x	x
3-point clamping force measurement		x	x	x	x	x	x	x	x

EASYLOCK zero point clamping system

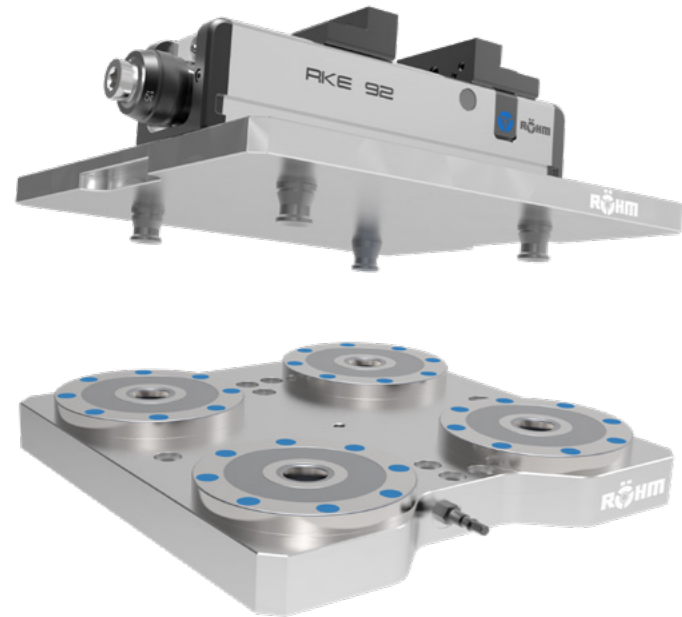

Palletising systems such as the EASYLOCK zero point clamping system from RÖHM achieve a considerable productivity increase. This modular system meets the requirements of customer-specific solutions with the best-possible utilisation of machine capacity. Although the machine tool had to stop for the set-up time until now, the workpiece can now be clamped and positioned on the pallet outside the machine tool. The set-up time is now only limited to loading and unloading the pallet, which happens in seconds. If multiple manufacturing processes are necessary for machining, then the pallet including the workpiece can be used without zero point loss. Due to the robust and rust-resistant construction, EASYLOCK zero point clamping can be used throughout, starting with machining up to the measuring machines.

THE BENEFITS AT A GLANCE

INCREASED PRODUCTIVITY

- ⊕ Free machine capacity through reduction of set-up time by up to 90%
- ⊕ Very rapid change of workpiece and clamping fixtures on tilt-free clamping and positioning with long insert

HIGH PRECISION

- ⊕ Repeat accuracy of < 0.005 mm thanks to precision balls
- ⊕ Positive-locking self-inhibition unaffected by tensile and lateral forces

HIGHEST MODULARITY

- ⊕ Modular base carrier design variants for maximum flexibility
- ⊕ Flexible extension options

The pin system

HOW IT WORKS

With the RÖHM EASYLOCK zero point clamping system, the clamping pin is the interface between the machine table and the workpiece or fixture. The exact positioning guarantees secure clamping. At the same time the resulting machining forces are transferred via the clamping pin to the pressure cup. The high-precision pressure cups of the EASYLOCK system ensure an absolutely secure hold of the workpiece or fixture. The high locking and holding forces make the system suitable for all kinds of use.



Machining with EASYLOCK?

EASYLOCK is ideally suited to all machining processes like grinding, milling, drilling and measuring.

What is meant by holding force?

Holding force is the force at which the pallet still rests securely on the clamping system. This force must not be exceeded during machining.

What is meant by repeat accuracy?

The repeat accuracy gives the tolerance range for the recorded workpiece references when the workpiece is removed and subsequently reclamped. The repeat accuracy of the EASYLOCK system is around < 0.005 mm.

REDUCED SET-UP TIMES BY UP TO 90%

Without palletising system



With EASYLOCK zero point clamping system

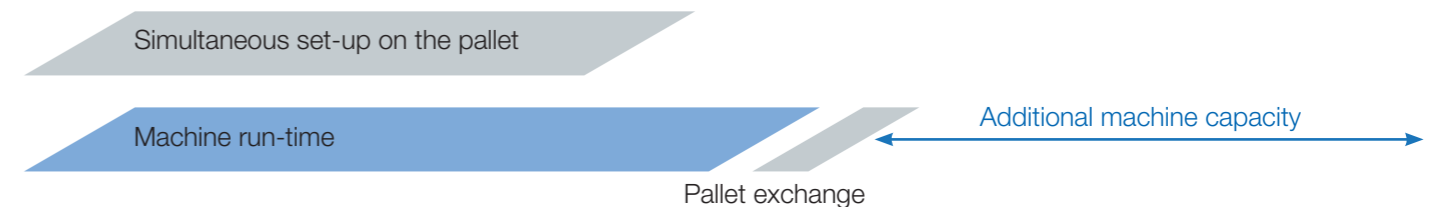

MZMF Hybrid chuck

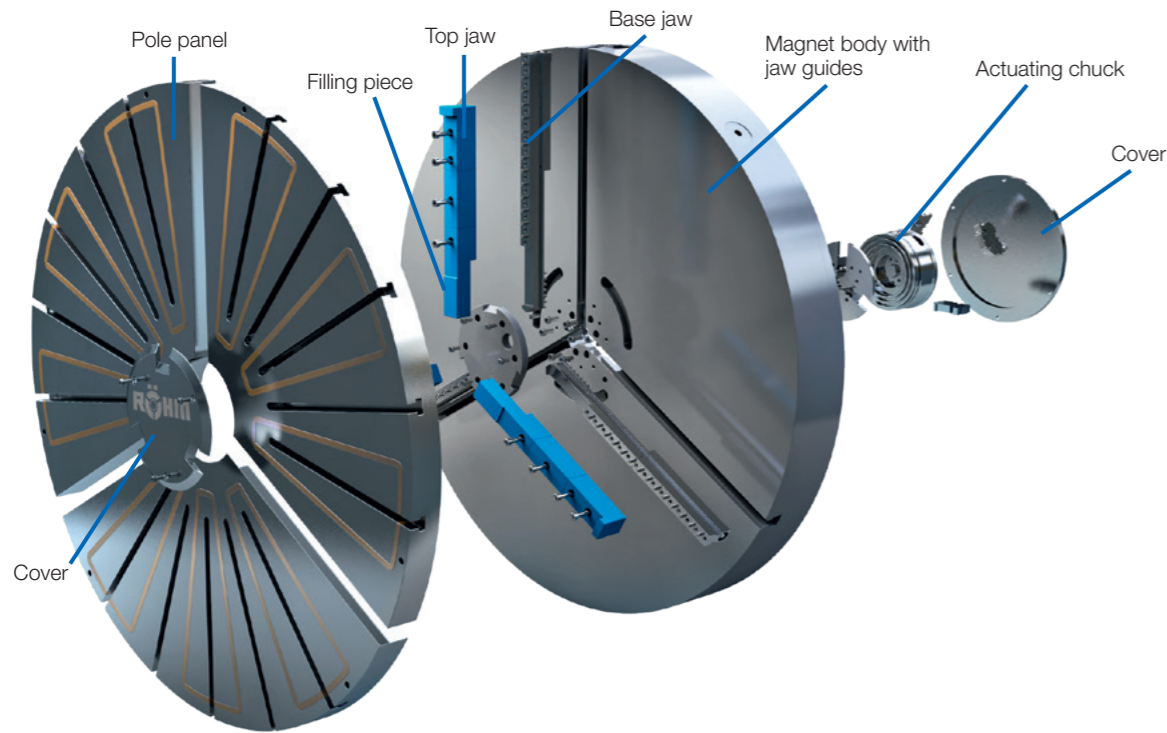

Combined 2-jaw centering chuck with magnetic clamping plate

A precisely centered and deformation-free setup is of utmost importance, especially for easily deformable workpieces which require turning machining from all three sides within one working operation. Thanks to the combination of magnetic clamping force and deformation-free centering, workpieces, such as rings or other hard-to-grip parts having a wide range of sizes and contours, can be precisely clamped within seconds with the hybrid chuck MZMF.

Technische Merkmale:

- ⊕ Set-up times reduced by up to 50%
- ⊕ Machine downtimes reduced to a minimum
- ⊕ 3-side machining for turning and grinding parts
- ⊕ 16 individually adjustable adhesion stages
- ⊕ Uniform and deformation-free setup
- ⊕ Combined magnetic and centering chuck clamping are possible
- ⊕ High process reliability for rational series production
- ⊕ Fast amortization

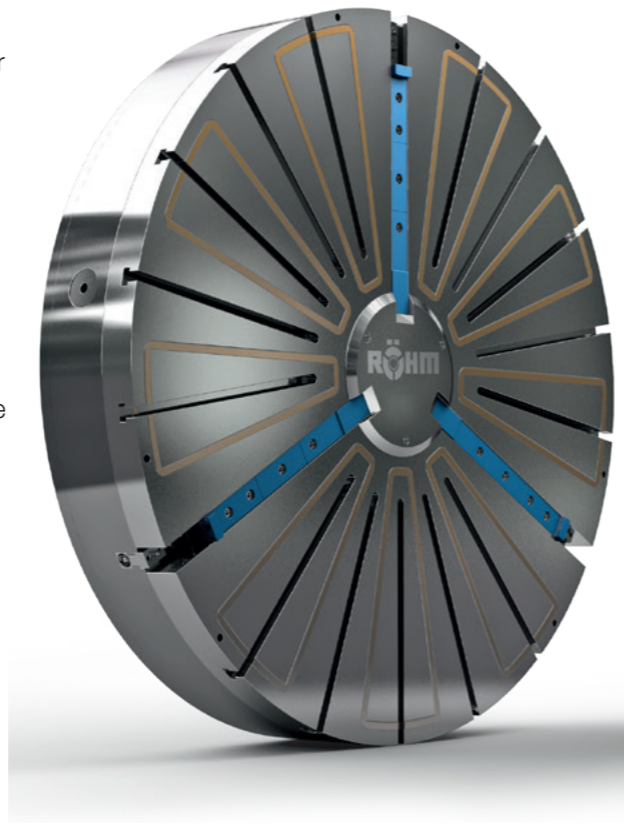

Other special solutions

For special customer demands, RÖHM offers an individual range of special solutions, which goes far beyond the standard product range. From the smallest „Micro Technology“ clamping chuck for watches and jewelry machining to impressive chucks with a diameter of over 5.5 meters and weight of 25 tons for rail vehicles or the energy sector.

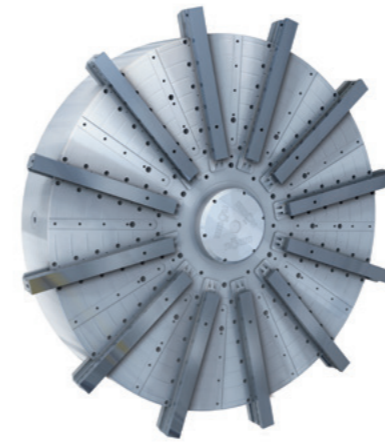

Machining of large bearings and rotary unions
Chuck for turning machining

- ⊕ Constant clamping force at high speeds by means of centrifugal force compensation
- ⊕ Integrated quick jaw change system for minimum setup times



Clamping chucks for rail traffic

- ⊕ Clamping diameters of up to 1.3 meters with flexible set-up for individually changing workpiece sizes
- ⊕ Automated jaw adjustment for inner and outer machining



Machining of large bearings and rotary unions
Chuck for drilling machining

- ⊕ Centrally clamping wedge hook chuck
- ⊕ Quickly adjustable clamping jaws and stops for minimum set-up times

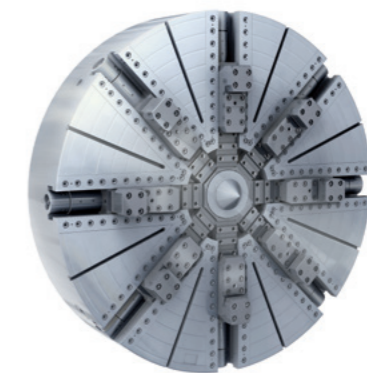

Independent chucks for power plants and steel mills

- ⊕ Clamping diameter of up to 5 meters
- ⊕ Safe clamping using power spindles allows up to 50 tons of clamping force per jaw

For further informations of our special solutions in any areas visit our homepage:
<http://www.roehm.biz/downloads/>

The headquarters: our main plant in Sontheim/Brenz

The RÖHM main plant is located in Sontheim/Brenz. In this ultra-modern production facility comprising 41,000 m² optimum conditions have been achieved in order to solve the extensive range of discerning construction and production tasks making the company even better, faster and more efficient in the future.



Sontheim/Brenz

Sontheim | All national and international activities are planned and coordinated at the administrative headquarters in Sontheim. Thanks to the excellent infrastructure and transport routes, this location is ideal for a company relying on perfect product quality as well as maximum flexibility. Furthermore, the region around Sontheim offers another key basis for the success of our company: it is rich in quality awareness and motivated employees with the result that we are ideally prepared for the challenges of the future. The main plant uniquely unites mass production, serial production and customised individual production under a single roof.

Key locations for the company: Dillingen and St. Georgen

Such strong growth on the part of the RÖHM Group is also obviously associated with higher requirements on development and production capacities. The demands of today and tomorrow can be complied with the two facilities in Dillingen and St. Georgen.



Dillingen/Danube

St. Georgen

Plant Dillingen/Danube | This branch plant in Dillingen was put into operation by the RÖHM Group as early as 1953. Thanks to extremely positive development, the plant is subject to constant expansion and modernisation. For this reason, new modern production facilities were built in 1982 and 1991. In 2007 RÖHM built a new production hall for two portal turning and milling machines. This enables machining of workpieces up to 4 metres in length which will secure a leading market position for RÖHM in the future. More than 300 employees are primarily involved in engineering and manufacturing lathechucks, machine vices and special clamping equipment for turning and milling machinery as well as for machining centres.

Engineering and sales department St. Georgen | Apart from standard mandrels, tailor-made solutions for a wide variety of requirements are also manufactured here in this small but accomplished high-tech forge. RÖHM retains mechanical or power-operated mandrels, sliding jaw mandrels and hydraulic mandrels for its customers for tensioning workpieces in drill holes or interior contours.

Always close to our customers.
With locations all around the world.



Customer orientation at RÖHM has less to do with marketing than with attitude. We consider customer proximity as an intensive dialogue with our partners as well as direct presence on key international markets.

Your contacts at RÖHM

Manufacturing and distribution bases

Germany:

RÖHM GmbH
Heinrich-Röhm-Straße 50
89567 Sontheim/Brenz
Tel 0049 73 25 – 16 0
Fax 0049 73 25 – 16 510
sales@roehm.biz
www.roehm.biz

RÖHM GmbH

Röhmstraße 6
89407 Dillingen
Tel 0049 90 71 – 5 08-0
Fax 0049 90 71 – 5 08-174
sales@roehm.biz
www.roehm.biz

RÖHM GmbH

Feldbergstr. 5
78112 St. Georgen
Tel 0049 – 77 24 – 94 68 12
Fax 0049 – 77 24 – 51 89
sales@roehm.biz
www.roehm.biz

China:

ROEHM China Co., Ltd.
Room 702, Building 24,
No. 518 Xinzhuan Road,
Songjiang District,
201612 Shanghai
Tel 0086 – 21 – 37 70 53 95
roehm.cn@roehm.biz
www.roehm.biz/zh

France:

RÖHM S.A.R.L.
325 rue Paul Langevin
BP 90204
F-60744 Saint Maximin cedex
Tel 0033 – 344 64 10 00
Fax 0033 – 344 64 00 68
fr.commercial@roehm.biz
www.roehm.biz/fr

Great Britain:

ROHM (Great Britain) LTD.
27 Webb Ellis Business Park,
Woodside Park, Rugby,
CV21 2NP
Tel +44 1788 228 469
rohmgb@roehm.biz
www.roehm.biz/en

Hungary:

RÖHM Hungaria Kft.
Gyár u. 2. (BITEP Ipari Park)
H-2040 Budaörs
Tel 0036 – 209 – 324 597
roehmhungary@roehm.biz
www.roehm.biz

Italy:

RÖHM Italia SRL
Via Reiss Romoli 17/19
20019 Settimo Milanese (MI)
Palazzo Rothenberger
Tel 0039 – 02 – 92 10 35 31
rohmitalia@roehm.biz
it.roehm.biz
www.roehm.biz/it

Mexico:

RÖHM Products México S. de R.L.
Emilio Garza Meléndez #6606
Col. Campestre Mederos
Monterrey, N.L., México, C.P. 64970
Tel 0052 81 – 9627 – 0686
info@rohm-products.com
www.roehm.biz/es

Poland:

ROEHM Polska Sp. z o.o.
ul. Sienna 73
00-833 Warszawa / Polska
Tel.: +48 605 665 663
roehmpolska@roehm.biz
www.roehm.biz

Spain:

RÖHM Iberica S.A.
C/Rejas, No. 9 Nave 11 D
28022 Madrid
Tel 0034 – 91 – 3 13 57 90
Fax 0034 – 91 – 3 13 57 93
rohmitterica@roehm.biz
www.rohmiberica.com
www.roehm.biz/es

Switzerland:

RÖHM Spanntechnik AG
Feldstraße 39, 3360 Herzogenbuchsee
Tel 0041 – 629 56 30 20
Fax 0041 – 629 56 30 29
roehm.ch@roehm.biz
www.roehm.biz

USA:

Roehm Products of America Inc.
2500 Northlake Drive,
Suwanee GA 30024
Tel +1-770-963-8440
Fax +1-770-963-8407
sales@rohm-products.com
www.rohm-products.com

Presence on all continents from A for Australia to V for Vietnam. You can receive the contact information of our worldwide representations easily through www.roehm.biz.

Sales Agents in Germany

Baden-Wuerttemberg:
Thomas Haas
Mobil 0152 / 22 88 71 20
thomas.haas@roehm.biz

Richard Sedlak
Mobil 0152 / 22 88 70 30
richard.sedlak@roehm.biz

Dirk Gaarz
Mobil 0152 / 22 88 71 16
dirk.gaarz@roehm.biz

Baden-Wuerttemberg / Rhineland-Palatinate / Saarland:
Michael Schmitz
Mobil 0152 / 22 88 70 18
michael.schmitz@roehm.biz

Bavaria North:
Steffen Blatz
Mobil 0152 / 22 88 70 16
steffen.blatz@roehm.biz

Bavaria South-West:
Gerhard Häutle
Mobil 0152 / 22 88 70 15
gerhard.haeutle@roehm.biz

Bavaria South-East:
Adolf Hausler
Mobil 0152 / 22 88 70 26
adolf.hausler@roehm.biz

North Rhine-Westphalia
Raif Schnichels
Mobil 0152 / 22 88 70 25
raif.schnichels@roehm.biz

Schleswig-Holstein, Hamburg, Bremen:
Friedhelm Schneider
Mobil 0152 / 22 88 70 17
friedhelm.schneider@roehm.biz

North Rhine-Westphalia / Lower Saxony
Thorsten Nolte
Mobil 0152 / 22 88 70 31
thorsten.nolte@roehm.biz

Berlin, Mecklenburg-Western Pomerania, Brandenburg, Saxony, Saxony-Anhalt, Thuringia:
Matthias Barth
Mobil 0152 / 22 88 71 46
matthias.barth@roehm.biz

Hesse:
Klaus Dieter Hofmann
Mobil 0152 / 22 88 70 29
k.d.hofmann@roehm.biz

Agents worldwide

Algeria:
RÖHM S.A.R.L.
325 rue Paul Langevin
BP 90204
F-60744 Saint Maximin cedex
Frankreich
Tel 0033 – 344 64 10 00
Fax 0033 – 344 64 00 68
fr.commercial@roehm.biz
www.roehm.biz/fr

Australia:
SECUREFIX
101 BRADMAN STREET
4110 ACACIA RIDGE QLD
Tel 61730633230
sales@securefix.com.au

Austria:
Martin Kremser
Untergreith 158
8443 Gleinstätten
Tel 00 43 / 66 49 23 77 10
martin.kremser@roehm.biz

Schachermayer GmbH
Schachermayer Str. 2
Postfach 3000, 4021 Linz
Tel 00 43 / 732 / 65 99-0
Fax 00 43 / 732 / 65 99 14 44
maschinenmetall@schachermayer.at

Lackner u. Urnitsch GmbH
Bahnhofgürtel 37, 8020 Graz
Tel 00 43 / 316 / 71 14 80-0
Fax 00 43 / 316 / 71 14 80 39
lackner@urnitsch.at

Metzler GmbH u. Co. KG
Oberer Paspelsweg 6-8, 6830 Rankweil
Tel. 00 43 / 55 22 / 7 79 63 - 0
Fax 00 43 / 55 22 / 7 79 63 - 6
office@metzler.at

Belgium:
RÖHM S.A.R.L.
325 rue Paul Langevin
BP 90204
F-60744 Saint Maximin cedex
Frankreich
Tel 0033 – 344 64 10 00
Fax 0033 – 344 64 00 68
fr.commercial@roehm.biz
www.roehm.biz/fr

BELTRACY
Bergenseseenweg 189
1600 Sint-Pieters-Leeuw
BELGIEN
Tel 00 32 / 25 43 68 90
Fax 00 32 / 25 38 59 10
info@beltracy.be
www.beltracy.be

Brazil:
O.V.D. Importadora e Distribuidora Ltda.
Rua João Bettega, 2876 – Portão –
CEP: 81.070-900
Curitiba, PR, Brazil
76.635.689/0001-92
(+41) 2101 2500

Canada:
Roehm Products of America Inc.
2500 Northlake Drive,
Suwanee GA 30024
Tel +1-770-963-8440
Fax +1-770-963-8407
sales@roh-products.com
www.rohm-products.com

Croatia:
PFEIFER - TTI D.O.O.
Spinciceva 2 a
40000 Cakovec, Kroatien
Tel 00 385-40391-123
Fax 00 385-40391-123
pfeifer-tti@pfeifer-tti.hr
www.pfeifer-tti.hr

Czech Republic:
RÖHM GmbH
Heinrich-Röhm-Straße 50
89567 Sontheim/Brenz
Tel 00421 914 122 932
peter.trnka@roehm.biz
www.roehm.biz

Denmark:
O. Ryttergaard Værktojs A/S
Falkevej 13
3400 Hillerød
Tel 00 45 36 70 65 55
info@ryttergaard.com
www.ryttergaard.com

Finland:
Teräskonttori Oy,
Muuntotie 3
1510 Vantaa
Tel 00 358 / 9615471
Fax 00 358 / 9674954
info@teraskonttori.fi
www.teraskonttori.fi

Oy Interfi Ltd.
Vähäheikkiläntie 56B, 2nd floor
20810 Turku
Tel 00 358 / 2 01 47 45 00
Fax 00 358 / 2 01 47 45 01
info@p-aro.com
www.interfi.com

Greece:
K.S.PAPADOPOULOS & CO.
ETHNIKIS ANTISTASEOS 7A,
55134 Thessaloniki
Tel 00 30 / 23 10-48 87 58
Fax 00 30 / 23 10-48 87 53
stefanos@agent.com.gr

Iceland:
Fossberg Ltd.
Dugguvogi 6, 104 Reykjavik
Tel. 00 354 / 57 57 600
fossberg@fossberg.is
www.fossberg.is

India:
R.H POWER UTILITIES PVT.LTD
KIADB 2ND PHASE
572106 TUMKUR KARNATAKA
Tel 0091 816 2970276
rhp.tmk@rajamane.com

OMKAR SUPRANATIONAL PVT LTD
SAHAKARNAGAR
411009 PUNE MAHARASHTRA
Tel 0091/2024223054
info@omkarsupra.com

Ireland:
ROHM (Great Britain) LTD.
27 Webb Ellis Business Park,
Woodside Park, Rugby,
CV21 2NP
Tel +44 1788 228 469
rohmb@roehm.biz
www.roehm.biz/en

Israel:
ETMOS ETM TOOLING LTD.
34 HAHOFER ST., 5885807 Holon
Tel. 00 972 - 3 / 55 81 933
Fax 00 972 - 3 / 55 81 934
etmos@etmos.co.il
www.etmos.co.il

Japan:
Takeda Trade Co., Ltd.
NAKANOSHIMA DAI-BUILDING 603, 3-3-23,
NAKANOSHIMA, KITA-KU
530-6106 OSAKA
Tel. 00 81 06-6441-1503
mail@takeda-trade.co.jp
www.takeda-trade.co.jp

Kazakhstan:
«Spanntech» LLP
Astana, st. Valikhanov 19, room 69
010000, Republic of Kazakhstan,
support@spanntech.kz

Letvia:
SIA „INSTRO“
LACPLESA STR. 87
1011 Riga
Tel 371/67288546
instrumentu.nodala@instro.lv

Luxemburg:
RÖHM S.A.R.L.
325 rue Paul Langevin
BP 90204
F-60744 Saint Maximin cedex
Frankreich
Tel 0033 – 344 64 10 00
Fax 0033 – 344 64 00 68
fr.commercial@roehm.biz
www.roehm.biz/fr

Macedonia:
DEMAX DOO
GROBLJANSKA NO.3, OSTRUZNICA
11251 Belgrade
Tel 00 381 / 1 1 26 52 999
Fax 00 381 / 1 1 26 52 562
office@demaxbg.com

Malaysia:
KS PRECISION TOOLS (M) SDN BHD
TAMAN SERDANG RAYA, SECTION 9
43300 SERI KAMBANGAN, SELANGO D.E.
Tel 60389417168
sales@ks-precision.com
www.ks-precision.com

Marocco:
RÖHM S.A.R.L.
325 rue Paul Langevin
BP 90204
F-60744 Saint Maximin cedex
Frankreich
Tel 0033 – 344 64 10 00
Fax 0033 – 344 64 00 68
fr.commercial@roehm.biz
www.roehm.biz/fr

Netherlands:
RÖHM S.A.R.L.
325 rue Paul Langevin
BP 90204
F-60744 Saint Maximin cedex
Frankreich
Tel 0033 – 344 64 10 00
Fax 0033 – 344 64 00 68
fr.commercial@roehm.biz
www.roehm.biz/fr

Boorwerk B.V.,
VELUWEZOOM 50
1327 AH, ALMERE
Tel 00 31 36 521 8080
Fax 00 31 36 521 4200
verkoop@boorwerk.nl
www.boorwerk.nl

Agents worldwide

Norway:
Ing. Yngve Ege A/S
Ryenstubben 5
0679 Oslo 11
Tel 00 47 / 23 24 10 00
Fax 00 47 / 23 24 1001
ege@ege.no
www.ege.no

KASPO MASKIN AS
Postboks 6282 Sluppen
7489 Trondheim
Tel 00 47 / 73 96 96 00
Fax 00 47 / 73 96 96 01
kaspo@kaspo.no

Portugal:
RÖHM Iberica S.A.
C/Rejas, No. 9 Nave 11 D
28022 Madrid
Tel 0034 – 91 – 3 13 57 90
Fax 0034 – 91 – 3 13 57 93
rohmliberica@roehm.biz
www.rohmliberica.com
www.roehm.biz/es

Paulo Fernandes
Tel 00351 926853881

Romania:
KSN Technik Srl
Str. Tabacarilor 15B/103
400139 CLUJ-NAPOCA, Rumänien
Tel 00 40 / 264 / 449 - 533
Fax 00 40 / 264 / 449 - 533
office@ksntechnik.ro
www.ksntechnik.ro

Singapore:
GP System Singapur PTE LTD
No. 51, Bukit Batok Crescent,
#04-04/05 Unity Centre,
Singapore 658077
Tel. 00 65 / 68 61 - 26 63
Fax 00 65 / 68 61 - 35 00
enquiry@gpsystem.com
www.gpsystem.com

Slovakia:
RÖHM GmbH
Heinrich-Röhm-Straße 50
89567 Sontheim/Brenz
Tel 00421 914 122 932
peter.trnka@roehm.biz
www.roehm.biz

Slovenia:
B T S COMPANY TRGOVINA
Bratislava 5
1000 Ljubljana
Tel 00 38 / 6 1 584 14 40
info@bts-company.si
www.bts-company.com

South Korea:
CHEONG-DO MACHINE TOOLS CO., LTD.
GURO-GO(GURO-DONG)
8212 Seoul
cdmt@chol.com

KMC CO.
DONGTANCHEOMDANSANEOP 1-RO
18469 HWASEONG-SI, GYEONGGI-DO
chelee@naver.com

Sweden:
Techpoint Systemteknik AB
Box 717
19127 Sollentuna
Tel 00 46 / 86 23 13 30
Fax 00 46 / 86 23 13 45
info@techpoint.se
www.techpoint.se

CHUCKTEKNIK NORDEN AB
Finjaryd 2519
28291 Tyringe
Tel 00 46 / 40 12 33 44
info@chuckteknik.com
www.chuckteknik.com

General Terms of Sale and Delivery

§ 1 Offer, conclusion of contract and contractual contents

- Our Terms of Sale shall apply exclusively; we do not recognise contradictory terms and conditions or terms and conditions which deviate from our Terms of Sale unless we had explicitly approved their validity in writing. Our Terms of Sale shall also apply if we carry out the delivery to the buyer without reservation in the knowledge of contradictory terms and conditions of the buyer or terms and conditions which deviate from our Terms of Sale.
- Our Terms of Sale shall only apply towards an entrepreneur within the meaning of Section 14 BGB [German Civil Code].
- Our General Service Terms shall apply with precedence over these Terms of Sale in the respective valid version in cases, which comprise the service offer of RÖHM GmbH.
- Our offers are always to be understood as invitatio ad offerendum and are therefore without obligation insofar as they have not explicitly been described as binding. The contract shall only be concluded with our written confirmation and in line with its contents and – if a written confirmation is missing – by the service/delivery. If a delivery/service is carried out immediately without a confirmation then the invoice shall at the same time be deemed as an order confirmation.
- Costs for the production of drawings for special constructions are to be borne by the orderer insofar as the offer does not lead to an order for reasons, for which we are not responsible.
- All details concerning weights, dimensions, services and technical data, which are contained in our printed material, catalogues, price lists or in other contractual documents, merely serve for purposes of information and are only binding insofar as they are explicitly described as binding.
- We reserve the right to make construction and form changes to the object of contract insofar as no changes are made hereto, which are deemed unreasonable for the orderer.
- The documentation consists of the compilation drawing, the BOM with marking of the parts subject to wear and tear and spare parts as well as assembly instructions upon request. Respectively in German and/or, upon request, in English. This free documentation will be supplied in a digital form. The PDF format shall apply to drawings, BOMs and texts. Any scope of documentation beyond this is liable to costs respectively requires a special agreement. The documents may not be reproduced in full or in part, not made accessible to third parties or used for any other purpose apart from that for which they were handed over to the customer without our prior written authorization.
- The corresponding measurement methods for tests, with which certain temperatures, times and other measured or control values should apply, must be stipulated before start of delivery and recognised by both parties. If no stipulation is made the measurement methods usually applied by RÖHM shall apply, we shall provide the details thereof upon request.
- Samples will only be supplied against payment and owing to a separately placed order.
- Assurances, collateral agreements and amendments to the contract require a written form in order to be valid. This requirement cannot be waived orally.
- Placed orders are irrevocable unless the supplier has approved the revocation in writing.
- In case of export business the delivery is carried out at the conditions agreed on the order confirmation, the international regulations for the interpretation of customary contractual forms shall apply in addition (incoterms 2010 of the International Chamber of Commerce, respective valid status).
- Our General Business Terms shall apply to the RÖHM online shop with the following supplementations:
 - The offer on the part of the customer is submitted binding as soon as the customer orders the products in the shopping basket by using the function „binding order“.
 - A purchase in the online shop is only possible if the customer actively agrees to our General Business Terms.
 - Mistakes and errors with regard to the goods availability, prices and other details and data excepted. Diagrams in the online shop are merely for the purpose of illustration respectively as visual aids; the description is binding.
 - We will inform the customer if the product ordered by the customer is temporarily or permanently not available.
- Our „product information“, technical information leaflets as well as other product-specific publications shall apply in addition to the General Business Terms. These are always to be complied with in their current version.
- When a contract is concluded between RöhM and the buyer, both parties undertake to observe and comply with the applicable laws and regulations as well as the current RÖHM code of conduct. You can find the code of conduct at: <https://www.roehm.biz/unternehmen/code-of-conduct/>

§ 2 Prices

- In the absence of special written agreements the prices in the Federal Republic of Germany shall apply „carriage paid“ recipient plus the statutory value added tax. With export business the object of delivery shall be deemed as sold „ex works“ if nothing is determined in the contract concerning the type of sale. A processing fee of EUR 15.00 will be charged for individual orders with a goods value of less than EUR 150.00 net, a processing fee of EUR 30.00 for orders with a goods value of less than EUR 50.00 net respectively plus the applicable rate of value added tax. This shall apply to deliveries within the domestic country and overseas. At the customer's request the goods can be delivered to an alternative shipping address against a logistics fee in the amount of EUR 10.00.
- We would like to point out that we will only carry out the shipment at the customer's request. This shall have no effect on the regulations according to Section 5.
- We shall charge the prices valid upon conclusion of the contract, which are based on the cost factors which are valid at this time. Should these cost factors (in particular material, wages, energy, etc.) change between conclusion of the contract and the agreed delivery time then we are entitled to make a corresponding change to the prices. In case of export business the supplier is entitled to terminate the contract extraordinarily with regard to the part of the order that has not yet been completed or to adjust the prices for this accordingly in the event of a substantial devaluation in the currency, in which the order is concluded.
- In case of conclusion ex works the goods will be conveyed at the costs and risk of the orderer. With all other consignments the provisions stipulated in the incoterms 2010, respective valid status, will apply with regard to insurance and the assumption of risks.
- We will inform the buyer of our production quantity for parts/products, which are produced especially according to the buyer's requests. The buyer undertakes to purchase

the quantities confirmed to him.

- Excess and shortfalls in deliveries of up to 5 %, with special tools up to 10 %, at least however 2 pieces, are permitted and do not substantiate any quality defects. The respective delivery will be charged.

§ 3 Terms of payment

- In the absence of a special agreement the payment is to be made without any deduction free paying agent within 10 days after the invoice date – also with partial deliveries.
- In case of default of payment interest will be charged in the amount of the credit costs charged by banks, at least however interest in the amount of 9 % above the respective base lending rate of the ECB.
- In case of export business the payments are to be made in line with the agreed terms of payment.
- Costs of the payment transactions, in particular bank charges for overseas transfers to us, shall principally be for the expense of the customer.

§ 4 Delivery time

- The start of the delivery deadline stated by us presumes the clarification of all technical questions. Delivery dates stated by us are – insofar as not explicitly agreed or described as binding – non-binding and shall merely represent an expected delivery date.
 - The compliance with our delivery obligation further presumes the timely and proper fulfillment of the buyer's obligations, in particular the compliance with the agreed terms of payment. The right is reserved to the plea of the unfulfilled contract. This right shall also consist of obligations from previous deliveries which have not been satisfied in full.
 - The delivery deadline shall begin with the sending of the order confirmation, however not before the provision of the documents, permit, releases, etc., which are to be procured by the orderer, as well as not before the receipt of the agreed down payment.
 - If a binding delivery date has been agreed then the supplier also has to deliver within the deadline. The delivery deadline shall have been adhered to if the object of delivery has left the plant by the time it expires or notification has been given that the object is ready for delivery, the right is reserved to the timely and correct self-delivery. If the orderer changes his order with regard to parts of the delivery then the delivery deadline shall only begin to apply new again with the confirmation of the change.
 - Force majeure, war, civil commotion, strike, lock-out or measures of authorities, no matter for what reason, which oppose a delivery, as well as deficiencies of raw materials, of transport means as well as theft – also at the sub-suppliers – shall release the supplier from the obligation to deliver within the agreed deadline. The orderer is to be notified immediately of the occurrence of the event and of the expected implications.
 - Deliveries before expiry of the delivery time and in reasonable parts are permitted.
 - The adherence to the delivery time presumes the fulfillment of the orderer's contractual obligations.
 - The regulations of Article 10 shall apply in the event of the delay in delivery or impossibility.
- ## § 5 Passing of risk and acceptance
- The risk shall pass to the orderer by no later than with the despatch of the delivered parts also if partial deliveries are made or we have taken over other services e.g. the shipping costs or delivery to the location and installation.
 - At the orderer's request the shipment shall be insured by us against theft, damages caused by breakage, transport, fire and water and other insurable risks at his costs.
 - If the shipment is delayed as a result of circumstances, for which the orderer is responsible, then the risk shall pass to the orderer from the day upon which the goods are ready for shipment; however we are obliged to procure the insurances, which he requests, at the request and costs of the orderer.
 - Delivered objects are, even if they feature insignificant features, to be accepted by the orderer irrespective of the rights from Section 8.

§ 6 Delay in acceptance, order on call

- If the orderer does not accept the object of contract within the deadline we are entitled to set him a reasonable final deadline, to dispose otherwise over the object after its expiry and to supply the orderer with a reasonably extended deadline. Our rights to cancel the contract under the pre-requisites of Section 326 BGB and to request damages owing to the non-fulfilment shall remain unaffected hereby. If we request damages owing to non-fulfilment we can request 40 % of the agreed price plus value added tax as compensation unless the orderer proves less damages. We reserve the right to assert higher actual damages.
- Orders, which are confirmed by us on call, must – insofar as nothing special has been agreed – be accepted by no later than within one year from the order date. The same shall apply in case of date reservations or sustainable „on call position“. Subclause 6.1 shall apply accordingly in case the goods are not called within the stated deadline.

§ 7 Reservation of title

- The objects of the deliveries (reserved goods) shall remain our property until the fulfilment of all claims to which we are entitled against the buyer from the business relationship. Insofar as the value of all security rights, to which we are entitled against the buyer, exceed the amount of all secured claims by more than 10 %, we will release a corresponding part of the security rights at the buyer's request.
- During the existence of the reservation of title the buyer is prohibited from a pledge or assignment as collateral and the resale only permitted for resellers in the customary course of business and only under the condition that the reseller receives a payment from his customer or stipulates the reservation that the property shall only pass to the customer when he has satisfied his payment obligations.
- In case of attachments, seizures or other disposals or interventions of third parties the buyer has to inform us immediately so that we can file an action according to Section 771 ZPO [German Code of Civil Procedure]. Insofar as the third party is not in the position to reimburse us the court and out-of-court costs of an action according to Section 771 ZPO, the buyer will be liable for the loss incurred to us.
- The buyer undertakes to treat the object of purchase with due care and attention; he is in particular obliged to sufficiently insure these at the value as new at his own costs against damages caused by fire, water and theft. Insofar as maintenance and inspection work is necessary the buyer must carry this out in time at his own costs.

General Terms of Sale and Delivery

- In case of breaches of duty by the buyer, in particular with default of payment we are entitled to cancellation and to take the goods back; the buyer is obliged to hand the goods over. The taking back of goods respectively the assertion of the reservation of title does not require any cancellation of the supplier; these acts or an attachment of the reserved goods by us shall not represent a cancellation of the contract unless we had explicitly declared this.
- If the buyer has resold the object of purchase in the ordinary course of business then he shall hereby now already assign all claims to us in the amount of the final invoice amount (including value added tax) of our claim, to which he is entitled from the resale against his buyers or third parties, irrespective of whether the object of purchase has been resold without or after processing. The buyer shall also remain authorized to collect this claim after the assignment. Our authorization to collect the claim ourselves shall remain unaffected hereby. However, we undertake not to collect the claim as long as the buyer satisfies his payment obligations from the collected proceedings, is not in default of payment and in particular no application has been filed for the opening of insolvency proceedings or payments have been suspended. If this is however the case we can request that the buyer announces the assigned claims and their debtors to us, provides us all details which are necessary for the collection, hands over the associated documents and informs the debtors (third parties) of the assignment.
- The processing or conversion of the object of purchase by the buyer is always carried out on our behalf. If the object of purchase is processed with other objects, which do not belong to us, then we shall acquire the co-ownership to the new object in the ratio of the value of the object of purchase (end invoice amount, including value added tax) to the other processed objects at the time of the processing. Incidentally, the same shall apply to the object produced by processing as to the object of purchase delivered under reservation.
- If the object of purchase is inseparably mixed with other objects that do not belong to us then we shall acquire the co-ownership to the new object in the ratio of the value of the object of purchase (end invoice amount, including value added tax) to the other mixed objects at the time of the mixing. If the mixing is carried out to the extent that the object of the buyer is to be seen as the main object then it shall be deemed as agreed that the buyer assigns us the pro rata co-ownership. The buyer shall store the thus produced sole ownership or co-ownership on our behalf.

§ 8 Quality defects

We shall be liable for quality defects as follows:

- All those parts or services are to be subsequently improved free of charge at our choice, delivered or provided new, which – irrespective of the operating duration – feature a quality defect if this cause existed already at the time when the risk was passed.
- Claims for quality defects shall become statute-barred in 12 months. The deadline will begin with the passing of the risk (Article 5).
- The buyer has to report quality defects to us immediately in writing.
- In case of reports of defects payments of the buyer may be withheld in a scope, which is in reasonable relation to the occurred quality defects. If the defect is unjustifiably reported we are entitled to request reimbursement of the expenses incurred to us by the buyer.
- We are first of all always to be granted the opportunity for the subsequent fulfilment within a reasonable period of time.
- If the subsequent fulfilment fails the buyer can – irrespective of possible claims for damages – cancel the contract or reduce the remuneration. The buyer can only request reimbursement for fruitless expenses if we are responsible for the defect owing to wilful intent or gross negligence.
- Defects shall not exist with an only insignificant deviation from the agreed conditions, with an only insignificant impairment to the usability, with natural wear and tear or damages, which are caused after the risk has passed as a result of faulty or negligent treatment, excessive use, unsuitable operating equipment or owing to special external influences, which are not presumed according to the contract, as well as with software faults that cannot be reproduced. If improper changes or repair work is carried out by the buyer or by third parties then this and the thus incurred consequences shall not substantiate any defects either. The same shall apply if our stipulations concerning the handling and other instructions are not complied with and a proper maintenance is not carried out.
- Claims of the buyer owing to the expenses, which are necessary for the purpose of the subsequent fulfilment, in particular transport, route, labour and material costs, are excluded if the expenses increase, because the object of the delivery has subsequently been taken to another location than the buyer's branch unless the transportation corresponds with its use as intended.
- Statutory claims for recourse of the buyer against us shall only exist to the extent that the buyer has not reached any agreements with its buyer that go beyond the statutory claims for defects.
- Article 10 shall apply to claims for damages. Further or other than claims regulated in this Article or in Article 10 owing to a quality defect are excluded.

§ 9 Industrial property rights and copyrights, defects of title

Insofar as not otherwise agreed, we are obliged to merely provide the delivery in the country of the place of delivery free of industrial property rights and copyrights of third parties (hereinafter property rights). Insofar as a third party asserts justified claims owing to the infringement of property rights due to deliveries provided by us and used as per contract against the buyer, we shall be liable towards the buyer as follows within the deadline determined in Subclause 8.2:

- We will, at our choice and at our costs, either obtain a right of use for the deliveries concerned, change these so that the property right is not infringed, or exchange these. If this is not possible for us at reasonable conditions, the buyer shall be entitled to the statutory rights to cancellation or reduction. The buyer can only request reimbursement for fruitless expenses if we are responsible for wilful intent or gross negligence. Our obligation to pay compensation is oriented to Article 10.
- The afore-mentioned obligations shall only exist if the buyer informs us immediately in writing about the claims asserted by third parties, does not recognise an infringement and we reserve the right to all defence measures and settlement negotiations. If the buyer discontinues the use of the delivery for reasons to minimise damages or for other important reasons he undertakes to inform the third party that the discontinuation of the use is not associated with a recognition of an infringement of a property right.
- Claims of the buyer are excluded insofar as he is responsible for the infringement of property right.

- Claims of the buyer are further excluded insofar as the infringement of property right is caused by special stipulations of the buyer, due to an application that is not foreseeable for us or by the fact that the delivery is changed by the buyer or is used together with products not delivered by us.
- In the event of infringements of property rights the provisions of Subclauses 8.4, 8.5 and 8.9 shall apply accordingly to the claims of the buyer regulated in Article 10.
- Further or other claims of the buyer against us or our vicarious agents owing to a defect of title than those regulated in this Article 9 are excluded.

§ 10 Joint and several liability

- Claims of the buyer for damages – irrespective of the legal nature of the asserted claim – are excluded.
- Excluded from this are:
 - Damages owing to the breach of essential contractual obligations. Deemed as essential are such contractual obligations, the fulfilment of which makes the proper execution of the contract possible at all and on the compliance with which the contractual partner may as a rule rely and depend on.
 - Damages from the injury to life, the body or the health if we are responsible for the breach of obligation.
 - For other damages, which are due to a wilful or grossly negligent breach of duty, whereby our breach of duty is deemed equivalent to that of our legal representatives or vicarious agents.
 - Liability according to the ProdHaftG [German Product Liability Act]
- A change to the burden of proof for the disadvantage of the buyer is not associated with the afore-mentioned regulations.
- Insofar as the liability for damages is excluded or limited against us, this shall also apply with regard to the personal liability for damages of our employees, our commercial agents and our vicarious agents.

§ 11 Obligations of the buyer to provide assistance

- Assistance services of the buyer, which are explicitly or tacitly agreed within the framework of the contract, shall be carried out without a special remuneration unless explicitly otherwise agreed.
- The buyer is obliged to inform us about all facts in time, from which it can be derived that goods and products in stock in our company, which we have made available with regard to the production capacities reported to us, cannot be used or not used in full. If residual stocks remain the buyer shall take over the stocks and the, if applicable incurred destruction costs in the event of a premature change to its material scheduling. This shall also apply to products, with which we had to order minimum quantities on the part of our suppliers if we have informed the customer hereof in advance.
- The buyer guarantees that the products supplied by him for processing are suitable for this purpose. We are not obliged to examine the products supplied by the buyer for the condition and the suitability for the further processing. Within the framework of ongoing business relationships as well as if an object for processing has initially been inspected, tested and released, the buyer undertakes to inform us of each product change without request in writing. In the case of regular processing of objects the buyer is further obliged to examine the object that is to be processed by us for deviations and changes for each change to the production conditions and in his company, in particular with the exchange of tools, machines or with the introduction of new production processes and to notify us of such changes and modifications in writing.
- We do not have to examine the instructions of our buyers, the material selection or other regulations, which are made by our buyer, for their accuracy.
- Therefore, the buyer has to examine all instructions, which he issues as well as the quality of the materials stipulated or made available to us for the compliance with the statutory and technical regulations.
- If the buyer is in default with regard to his obligation for provision or to provide assistance after a written warning we are entitled to the statutory rights.
- Goods may only be returned with the supplier's express permission. Any returned goods must be delivered free in their original packaging and must be accompanied by the return receipt provided by the supplier. The goods must be in their original state, i.e. undamaged and fully functional. Returned goods will no longer be accepted when six months have lapsed from the date of delivery. Returns of specially designed or custom-made items, as well as used goods will not be accepted. We will charge a handling fee of 20 % - 40 % of the value of the goods, however, at least EUR 100 per item plus statutory VAT. Following presentation of appropriate evidence, the supplier reserves the right to charge a higher amount to the purchaser in individual cases; the purchaser is free to prove that the damage was lower.

§ 12 Place of performance, Choice of Law and Place of Jurisdiction

- The place of performance and place of payment is the registered seat of our company in Sontheim/Brenz.
- The law of the Federal Republic of Germany is to be exclusively applied to the contractual relationship. The application of the Convention of the United Nations of 11 April 1980 concerning Contracts for the International Sale of Goods (CISG „Law governing the sale of goods of Vienna“) is excluded.
- With all disputes ensuing from the contractual relationship, if the orderer is a merchant, a legal entity under public law or a special fund under public law, the action is to be filed at the court that has jurisdiction for our headquarters. We are also entitled to file action at the headquarters of the orderer.

§ 13 Data protection

We process personal data in accordance with the General Data Protection Regulation (GDPR) and the Federal Data Protection Act (BDSG).

RÖHM GmbH
89565 Sontheim (Germany)

Status: July 2024

General Service Terms (ASB) of RÖHM GmbH, Sontheim

1. Validity

1.1 These ASB form the basis for all business transactions with our customers, which refer to the repair or maintenance of the products manufactured or delivered by us insofar as these customers concern entrepreneurs within the meaning of Section 14 BGB [German Civil Code].

1.2 Contradictory, supplementary contractual terms and conditions of the customer or those which deviate from these ASB will not be recognised.

1.3 Within the framework of a regular business relationship these ASB will also be valid after the effective inclusion for the first time if we do not explicitly refer hereto in follow-up transactions.

1.4 Insofar as the ASB do not include any regulations, the General Terms of Sale and Delivery of RÖHM GmbH shall apply.

2. Offer and conclusion of the contract

2.1 Our offers are – insofar as not explicitly marked as binding – without obligation and merely to be understood as *invitatio ad offerendum*. The right is reserved to an interim sale.

2.2 Contracts with us will only be concluded with our written acceptance declaration or – if such is not carried out – by our delivery and service. Changes and supplementations to the contracts concluded with us require a written form.

2.3 If the object of maintenance or repair was not delivered by us then the customer has to point out existing industrial property rights with regard to the object if we are not responsible for any fault the customer shall indemnify us from possible claims of third parties from industrial property rights.

2.4 Insofar as we are responsible for negligence Par. 2.3 shall apply accordingly.

3. Contractual parts

The offer and the product list respectively available to us and the customer are a part of the contract.

4. Technical documents and plans

4.1 All rights to our offer documents as well as documents, which have been handed over, shall remain reserved.

4.2 The customer shall recognise our rights and will not reproduce the documents in full or in part, not make these accessible to third parties or use these for any other purpose than that for which they were handed over to him without our prior written authorization.

5. Scope of services, maintenance, condition of device, repair

5.1 Decisive for the scope of our delivery and service is our binding offer or – if such is not available – our written declaration of acceptance. Both individual services can be agreed, which are principally to be remunerated according to Subclause 12.1, as well as the service packages described under Subclause 5.2, which are to be remunerated according to 12.2 respectively 12.3.

5.2 The following activities are a part of our service obligation with the processing of service packages:

5.2.1 Commissioning of service

- skilled execution of the necessary commissioning of the clamping device and control at the place of installation in line with the regulations of the manufacturer.
- assembly work over the course of the commissioning together with the machine manufacturer
- first instructions and operator training
- we will invoice separate requests for the training with regard to the maintenance and use as separate work.

5.2.2 Inspection service

Skilled execution of the necessary inspection of the clamping device and control at the place of installation in line with the regulations of the manufacturer. Insofar as additional maintenance or repairs become necessary at the customer's request or owing to special loads, these are to be remunerated separately by the customer.

5.2.3 Maintenance service

Skilled execution of the necessary maintenance of the clamping device and control at the place of installation in line with the regulations of the manufacturer. Insofar as additional repairs become necessary at the customer's request or owing to special loads, these are to be remunerated separately by the customer.

5.3 The service obligation shall begin with the purchase or conclusion of a service package. With the purchase or conclusion of a service package after the expiry of the warranty period the service obligation of RÖHM shall only refer to such products, which are capable of use and free of defects at the time of the conclusion or purchase of the service package. This is to be ensured by an inspection of the products; if defects are determined these are to be remedied before the start of validity of the service package by a necessary repair liable to costs; this repair is not part of the service package.

5.4 Our service obligation shall not include carrying out work on products and accessories, which was(were) not delivered by us.

5.5 Our service obligation shall lapse if the product was not subjected to the function and safety tests according to the details in the operating instructions or third parties have carried out work on the products concerned without our prior written consent unless this work has no disadvantageous influence on the provision of our service. The same shall apply if the products have been damaged due to causes for which we are not responsible, for example by water, fire, stroke of lightning or other implications of force majeure as well as with improper treatment by the customer or third parties.

5.6 Depending on the use and type of the product an overhaul may be necessary after longer use. This is the case if the costs of a repair exceed the current value of the product. Overhaul within this meaning is also the necessary new acquisition of a product in the absence of available spare parts. Overhauls are not part of the service obligation within the service packages. If we are of the opinion that a products that is to be maintained by us under a service package requires an overhaul, we will inform the customer hereof by stating the current value estimated by us and submit an offer for the overhaul to the customer with a remuneration calculated according to 12.1.

6. Repair/service that cannot be carried out

6.1 The services provided concerning the details of a cost estimate as well as the further incurred and to be proven work (fault search time equal to working hours) will be invoiced to the customer if the repair cannot be carried out due to reasons for which RÖHM GmbH is not responsible, in particular because the fault for which a complaint will be made did not occur during the inspection, spare parts cannot be procured, the customer culpably missed the agreed date or the contract was terminated during the execution.

6.2 The object of repair only needs to be restored to the original condition again at the explicit request of the customer against reimbursement of the costs unless the undertaken work was not necessary.

6.3 In case of a repair that cannot be carried out RÖHM GmbH shall not be liable subject to sentence 2 for damages to the object of repair, the breach of contractual secondary obligations and for damages, which were not suffered to the object of repair itself, no matter to which legal grounds the customer refers. RÖHM, on the other hand, will be liable in case of wilful intent, with gross negligence of the owner / the executive bodies or executives as well as with the culpable breach of essential contractual duties. Such contractual obligations are deemed essential, the fulfilment of which makes the proper execution of the contract possible at all and the compliance with which the contractual partner may as a rule rely and depend upon.

7. Duration of the service

7.1 The details with regard to the duration of repairs and services are based upon estimates and merely serve as information and a first estimate by the customer. They are therefore not binding if they have not been explicitly marked as binding.

7.2 In case of subsequently placed additional and extension orders or with necessary additional repair work the agreed repair deadline shall be extended accordingly.

8. Obligations to provide assistance of the customer

8.1 The customer has to draw our attention to the statutory, official and company safety and other regulations applicable at the place of destination of our delivery and service, which refer to the delivery, the assembly and the operation.

8.2 The customer will inform us with or immediately after his order about possible special features of the place of installation, which may have an implication on the proper function of the products, in particular about the structural condition and the concrete operating environment.

8.3 The customer shall ensure – also during the warranty period according to Subclause 17.5 – a regular and skilled maintenance of the products delivered by us insofar as this was not taken over by us as per contract.

8.4 The customer shall dispose of the goods delivered by us at his own responsibility and at his own costs according to the respective valid regulations. We are not obliged to create a possibility for the return unless this would have been stipulated by law.

8.5 The customer has to support the repair / maintenance personnel with the execution of the repair at his own costs.

8.6 The customer has to take the special measures, which are necessary for the protection of persons and objects at the workplace. He also has to inform the repair managers about existing special safety regulations insofar as these are of significance for the repair personnel. He shall inform us in case of breaches of the repair personnel of such safety regulations. In case of serious breaches he can refuse the infringing party access to the repair location by mutual agreement with the repair manager.

8.7 The customer shall bear a supervisory and assistance obligation for the compliance with the statutory working time limits. Breaches are to be reported to RÖHM GmbH.

8.8 The customer is obliged to provide the reasonable and necessary technical assistance at his costs, in particular to:

- Provision of the necessary, suitable assistants in the number that is necessary for the repair and for the necessary time; the assistants have to follow the instructions of the repair manager. We do not assume any liability for the assistants. If a defect or damages were caused by the assistants owing to instructions of the repair manager, then the regulations of Sections 17 and 18 shall apply accordingly.
- Undertaking of all construction, bedding and scaffolding work including the procurement of the necessary building materials.
- Provision of the necessary devices and heavy tools as well as the necessary commodities and required materials.
- Provision of heating, lighting, operating power, water, including the necessary connections.
- Provision of necessary, dry rooms, which can be locked for the storage of the tool for the repair personnel.
- Protection of the repair place and materials against harmful influences of all kinds, cleaning of the repair place.
- Provision of suitable, theft-proof recreation rooms and work rooms (with heating, lighting, washing possibility, sanitary facilities) and First Aid for the repair personnel.
- Provision of the materials and undertaking of all other acts, which are necessary for the adjustment of the object of repair and for carrying out a testing that is envisaged as per contract.

8.9 The technical assistance of the orderer must guarantee that the service can be started immediately after the arrival of our personnel and carried out without delay until the acceptance by the orderer. Insofar as special plans or instructions of RÖHM are necessary, RÖHM shall make these available to the orderer in time.

9. Obligations of the customer to provide assistance in case of maintenance

9.1 The products are to be used as intended and according to their protection type and in line with the operating instructions together with their annexes.

9.2 In case of an agreement of one of the service packages described in Subclause 5, the customer will place the products that are to be installed, maintained or repaired into a faultless condition, capable of use before conclusion of the contract at his own costs if the products are not already in such a condition. If the customer does not properly satisfy this obligation either after a warning on our part and within the deadline we are entitled to accordingly cancel the contract or the delivery. Further claims for damages on our part shall remain unaffected.

9.3 If the customer uses the maintenance service interferences are to be reported to us immediately in writing, in detail and in an understandable manner.

9.4 Our employees and vicarious agents are to be granted the unimpeded and safe access to the products. In case of delays for which the customer is responsible he is obliged to remunerate the waiting times of our employees and vicarious agents resulting from the delay separately.

9.5 The customer shall refrain from commission third parties with the services during the term of a service agreement, which we have to provide according to the agreement or from performing this work himself.

9.6 The customer has to draw our attention to the statutory, official and company safety regulations and other regulations applicable at the place of destination of our delivery and service, which refer to the delivery, the assembly and the operation.

10. Inspection and acceptance

10.1 Services will be provided by us according to the guidelines of our quality control and deliveries inspected accordingly. If the customer requests further inspections then these are to be agreed in writing and paid by the customer. This shall relate e.g. to special tests for the acceptance.

General Service Terms (ASB) of RÖHM GmbH, Sontheim

10.2 The customer undertakes to accept our services under this contract immediately after the report that they have been completed. Upon request he has to declare their acceptance in writing towards our employees or vicarious agents insofar as there is no essential defect. This is carried out by the signing of the service report.

10.3 Our services shall be deemed as accepted free of defects with the re-commencement of the operational use of the maintained or repaired product, in particular for production purposes, if no defects have been previously reported by the customer.

11. Cost details and cost estimate

11.1 The creation of the cost estimates is liable to costs if the execution of the repair is not approved.

11.2. The costs for a cost estimate amount to the flat rates fixed in the current price list.

11.3 If the repair cannot be carried out at these costs or if our employees or vicarious agents consider the execution of additional work to be necessary during the repair the customer's consent is to be obtained if the stated costs are exceeded by more than 15%.

12. Remuneration, maturity and terms of payment

12.1 Insofar as not otherwise agreed and there is no warranty case our services are to be remunerated according to the actual work requirement pursuant to our respectively valid general price lists. The time required by our employees will be settled in time sections of 15 min. In addition to the time required for the work that is to be performed in these cases the customer will pay the travelling and waiting times, overtime surcharges, expenses, travelling and accommodation costs as well as the costs of spare parts, materials subject to wear and tear and consumables and replacement part sets according to our prices lists or in line with the offer.

12.2 Insofar as a flat rate remuneration was agreed for a service package, our work and travelling costs and expenses are thus covered, not however the costs for waiting times, overtime at the customer's request, spare parts, materials subject to wear and tear and consumables, replacement parts sets as well as other accessories. Our work for if applicable necessary repairs is to be remunerated separately by the customer according to Subclause 12.1.

12.3 The prices for our services can be derived from the respective price list valid upon conclusion of the contract and are deemed ex works plus value added tax. The calculation basis for the remuneration is the one-shift operation, i.e. a use of the products up to 160 hours in a calendar month. A surcharge to the list price of 50% is charged for the two-shift operation, a surcharge of 100% for the three-shift operation. The above two rates shall only apply to the service packages described under Subclause 5.. If the customer requests assignments outside of our normal working hours (Mo - Fr, 6:30 am - 6:30 pm, a max. of 7 h per day) surcharges will be calculated according to the respective valid price list.

12.4 If our personnel and material costs are increased then we are entitled to adjust the contractual prices after the expiry of the first year up to a maximum of 5% above the price of the previous year. Price changes will be announced to the customer at least one month before the new contractual prices come into force. The customer is entitled to terminate the contract effective as of the time at which the new price would become valid for him for the first time.

13. Transport and insurance with the repair in the plant of RÖHM GmbH

13.1 The object for repair will be delivered by the customer to us at his costs together with the repair and service form and after execution of the repair collected by the customer again or return to him at the customer's costs.

13.2 The customer shall bear the risk of transport.

13.3 At the customer's request a shipment carried out by us will be insured at the customer's costs against the insurable transport risks, e.g. theft, breakage and fire.

13.4 No insurance cover exists during the repair time in our plant. The customer has to ensure the maintenance of the existing insurance cover for the object of repair e.g. with regard to fire, pipe water, storm and machine breakage insurance. Insurance cover can only be procured for these risks at the explicit wish and costs of the customer.

13.5 In case of delay of the customer with the take-over we can charge a storage fee for the storage in our plant. The object of repair can also be stored otherwise at our discretion. The costs and risk of the storage during the delay shall be for the expense of the customer.

14. Repair deadline

14.1. The details concerning the repair deadlines are based on estimates and merely serve for the purpose of information and first orientation. They are therefore not binding unless this is explicitly agreed.

14.2. The agreement of a binding repair deadline, which must be described as binding, can only be requested by the customer if the scope of the work has been precisely determined.

14.3. The binding repair deadline will have been adhered to if by the time that it expires the object of repair is ready for take-over by the customer, in the event of a contractually envisaged testing ready for its execution.

14.4. In case of subsequently placed additional and extension orders or with necessary additional repair work the agreed repair deadline will be extended accordingly.

14.5. If the repair is delayed due to measures within the scope of industrial disputes, in particular strike and lock-out as well as the occurrence of circumstances, which were not caused by us, a reasonable extension to the repair deadline will occur insofar as such impediments have as proven a substantial influence on the completion of the repair; this shall also apply if such circumstances occur after we are in default.

15. Ban on offsetting and assignment; subcontractors

15.1 The customer is only entitled to offsetting in the event of undisputed claims or claims which have been declared final and binding. This shall not apply if the customer asserts claims in the reciprocal relationship, in particular claims for defects.

15.2 The assignment of rights of the customer from contractual relationships with us presumes our prior consent in order to be valid. This shall not apply insofar as Section 354 a HGB [German Commercial Code] applies.

15.3 We are entitled to use third parties in order to fulfil our contractual obligations.

16. Reservation of title

16.1 The goods delivered by us shall remain our property until the payment of all of our claims against the customer, no matter for what legal grounds, also future ones. In case of current account the afore-mentioned property shall be deemed as security for our balance claim.

16.2 The customer may only sell within the framework of his customary business transactions and neither pledge, nor assign the goods as collateral. The customer hereby

assigns us for security of our payment claims against him, in the amount of the value of our delivery and service, all claims with all secondary rights, which he acquires against his buyer owing to such a sale.

16.3 As long as the property has not yet been assigned, the customer has to inform us immediately in writing if the delivered object is attached or is exposed to other interventions of third parties. Insofar as the third party is not in the position to reimburse us the court and out-of-court costs of an action according to Section 771 ZPO [German Code of Civil Procedure] the customer shall be liable for the loss incurred to us.

16.4. We undertake to release the securities to which we are entitled at the customer's request insofar as their value exceeds the claims which are to be secured by more than 20 %."

17. Warranty

17.1 Insofar as the creation of a work has been agreed and thus the law governing contracts for work and services applies the following shall apply: If our services are faulty then we are first of all entitled and obliged to subsequent satisfaction according to Section 634 No. 1 BGB. If the subsequent satisfaction finally fails the customer can according to Section 634 No. 3 cancel the contract or reduce the remuneration and according to Section 634 No. 4 BGB request damages. Claims of the customer for reimbursement of expenses according to Section 634 No. 2 BGB (self-execution) are excluded. Subclause 18 shall apply to claims for damages.

17.2 Insofar as we provide planning services without executing these and thus the law governing service contracts applies (e.g. in the event of a breach of our duties under Subclauses 5.2.1, 5.2.2 and 5.2.3) the following applies: If our services are faulty then we are first of all entitled and obliged to subsequent improvement. If the subsequent improvement finally fails the customer is entitled to damages according to Subclause 18.

17.3 Excluded from the warranty are damages as a result of natural wear and tear, faulty maintenance – insofar as we have not carried out this maintenance as per contract, failure to comply with operating equipment regulations, excessive use, unsuitable operating equipment, chemical or electrolytic influences, faulty construction and assembly work of third parties as well as other causes, for which we are not responsible.

17.4 The warranty shall lapse if the customer or third party makes changes or repairs to our services /products without our prior written consent unless the defect is not a result thereof.

17.5 Claims of the customer owing to defects of quality and title shall become statute-barred with the expiry of 12 months after the acceptance of the work or the knowledge of defects with the provision of planning services.

18. Liability

18.1 We shall be liable to an unlimited extent in case of wilful intent and gross negligence as well as with the injury to life, the body and the health as well as with the culpable breach of essential contractual obligations. Deemed as essential are such contractual obligations, the fulfilment of which makes the proper execution of the contract possible at all and the compliance with which the contractual partner may as a rule rely and depend on.

18.3 Incidentally our liability is excluded.

18.4 A liability according to the Product Liability Act remains unaffected.

18.5 The personal liability of our legal representatives and vicarious agents is limited as our own liability according to the afore-mentioned provisions.

19. Term of the contract; termination

19.1 Service agreements according to Subclause 5. shall come into force when signed by both parties and shall initially apply until the end of the calendar year, that follows the year in which the contract was concluded. The contractual relationship will subsequently be extended respectively by one further year unless it is terminated by one of the parties with a period of notice of 3 months to the end of the second or a following year. Contractual relationships can be terminated on the whole or only with regard to individual products.

19.2 The right to the extraordinary termination for an important reason remains unaffected.

20. Place of jurisdiction; applicable law

20.1 With all disputes ensuing from the contractual relationship if the orderer is a merchant, a legal entity under public law or a special fund under public law, the action is to be filed at the court that has jurisdiction for our headquarters. We are also entitled to file an action at the headquarters of the orderer.

20.2 The legal relationship is subject to the law of the Federal Republic of Germany. German international private law and the Viennese Convention of the United Nations concerning Contracts for the International Sale of Goods (CISG) will not apply.

RÖHM GmbH

89565 Sontheim (Germany)

Status: July 2024



Notes

Notes



Notes

Notes

RÖHM GmbH

Heinrich-Röhm-Straße 50

89567 Sontheim/Brenz

Germany

Tel +49 7325 16 0

Fax +49 7325 16 510

info@roehm.biz

www.roehm.biz



Id.-Nr. 1178263 / 0823