

1969-2024

Al ruim 55 jaar partner
in efficiënt produceren

NAJAARSPROMOTIE

Geldig t/m 31 december 2024

Alle prijzen exclusief 21% BTW en verzendkosten

HAGRO

www.hagro.nl

| precisie bv

UltraMini Performance Line P50

Uitdraaien en kopiëren

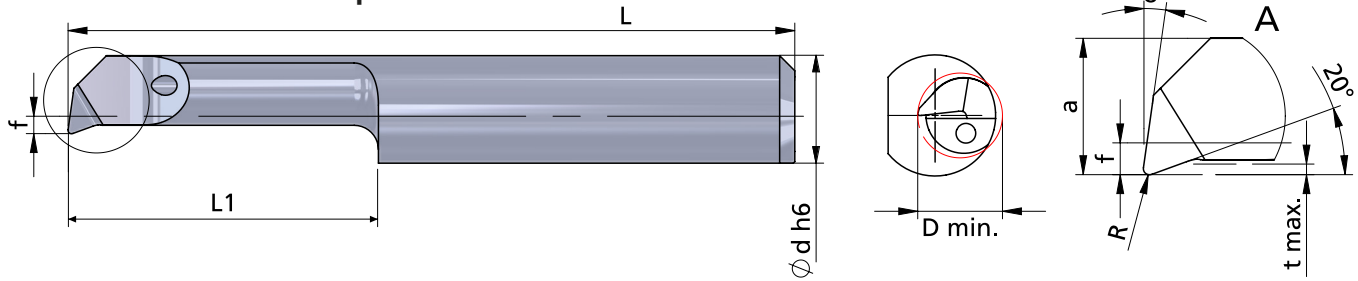

Ø	Dmin	Radius	f	a	L	L1	Tmax	Artikel rechts	Bruto	Actie
4	4,0	R = 0,10	1,5	3,5	34	20	0,3	RP50.4-20/P04C	€ 25,11	€ 21,10
5	5,0	R = 0,15	1,9	4,4	40	25	0,5	RP50.5-25/P04C	€ 27,18	€ 22,90
6	6,0	R = 0,15	2,3	5,3	45	30	0,5	RP50.6-30/P04C	€ 30,51	€ 25,70
7	6,8	R = 0,15	2,8	6,3	50	35	0,6	RP50.7-35/P04C	€ 35,33	€ 29,70

UltraMini Performance Line P60

Uitdraaien en aanschuiven

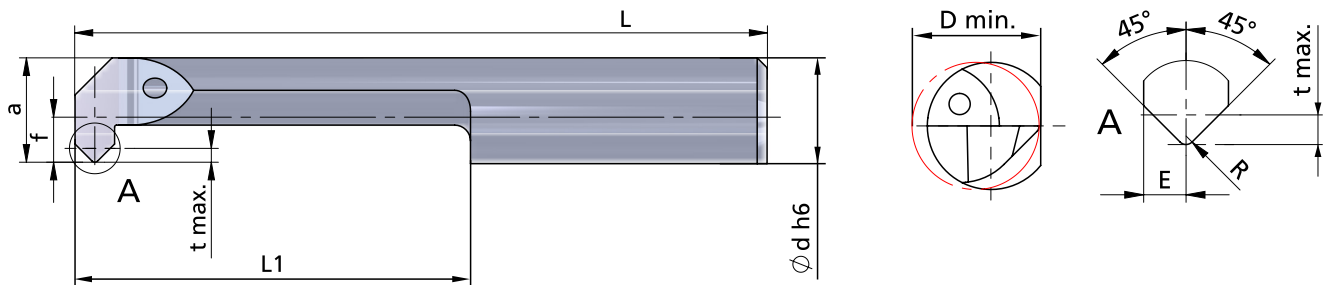

Ø	Dmin	E	R	f	a	L	L1	Tmax	Artikel rechts	Bruto	Actie
4	3,0	0,60	0,2	0,7	2,7	24	10	0,4	RP60.3-10/P04C	€ 24,53	€ 20,70
4	4,0	0,75	0,2	1,5	3,5	30	16	0,5	RP60.4-16/P04C	€ 25,88	€ 21,80
5	5,0	1,00	0,2	1,9	4,4	30	15	0,7	RP60.5-15/P04C	€ 24,53	€ 20,70
5	5,0	1,00	0,2	1,9	4,4	35	20	0,7	RP60.5-20/P04C	€ 25,16	€ 21,20
6	6,0	1,00	0,2	2,3	5,3	35	20	0,7	RP60.6-20/P04C	€ 25,47	€ 21,40
6	6,0	1,00	0,2	2,3	5,3	40	25	0,7	RP60.6-25/P04C	€ 28,98	€ 24,40
7	6,8	1,00	0,2	2,8	6,3	35	20	0,7	RP60.7-20/P04C	€ 28,58	€ 24,10
7	6,8	1,00	0,2	2,8	6,3	55	40	0,7	RP60.7-40/P04C	€ 44,73	€ 37,60

UltraMini Performance Line 1P

Draadsnijden, volprofiel

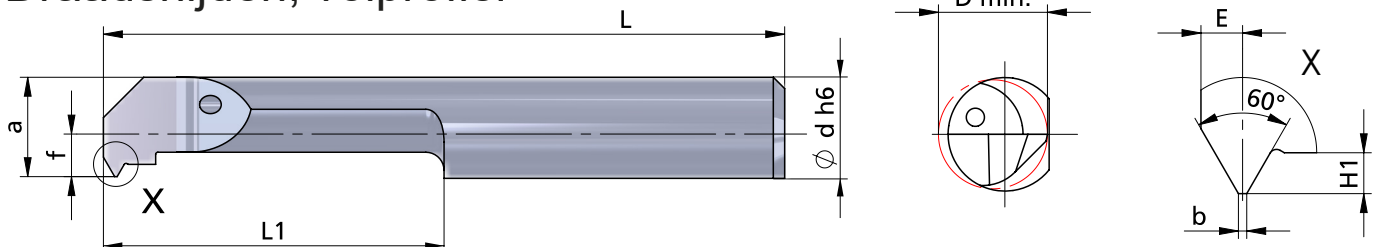

Ø	Dmin	Spood	Draad	H1	E	b	f	a	L	L1	Artikel rechts	Bruto	Actie
4	4,0	0,80	M5	0,43	0,50	0,10	1,5	3,5	30	15	R1P4.0408-15/P04C	€ 27,54	€ 23,20
5	4,8	1,00	M6	0,54	0,55	0,12	1,9	4,4	30	15	R1P5.0510-15/P04C	€ 26,10	€ 22,00
6	6,0	1,25	M8	0,67	0,65	0,15	2,3	5,3	30	15	R1P6.0612-15/P04C	€ 26,10	€ 22,00
6	6,0	1,50	M10	0,81	0,75	0,18	2,3	5,3	30	15	R1P6.0815-15/P04C	€ 26,10	€ 22,00
7	7,0	1,50	M10	0,81	0,75	0,18	2,8	6,3	30	15	R1P7.0815-15/P04C	€ 26,55	€ 22,30

Draaibeitels type D voor uitwendig gebruik

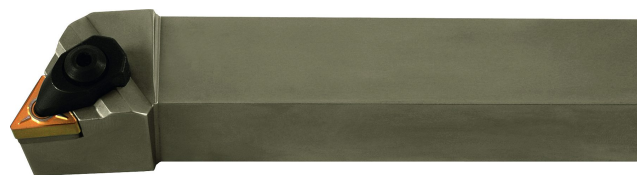
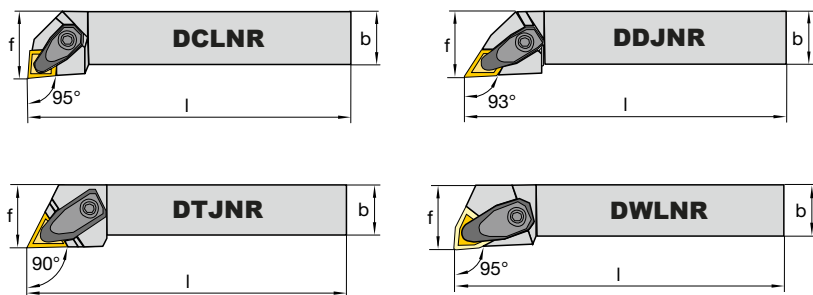

Combinatiekorting !

Draaibeitel GRATIS bij aanschaf van 40 wisselplaten met BC geometrie !

Aantal wisselplaten (BC)

Draaibeitel	Plaatzitting	H	B	F	L	Artikel	Bruto	10x	20x	30x	40x
DCLNR 2020 K12	CN...1204..	20	20	25	125	5009529	€ 98,43	-25%	-50%	-75%	gratis
DCLNR 2525 M12	CN...1204..	25	25	32	150	5009454	€ 107,97	-25%	-50%	-75%	gratis
DDJNR 2020 K15	DN...1506..	20	20	25	125	5009527	€ 98,43	-25%	-50%	-75%	gratis
DDJNR 2525 M15	DN...1506..	25	25	32	150	5009452	€ 107,97	-25%	-50%	-75%	gratis
DTJNR 2020 K16	TN...1604..	20	20	25	125	5009460	€ 98,43	-25%	-50%	-75%	gratis
DTJNR 2525 M16	TN...1604..	25	25	32	150	5009285	€ 107,97	-25%	-50%	-75%	gratis
DWLNR 2020 K08	WN...0804..	20	20	25	125	5009459	€ 98,43	-25%	-50%	-75%	gratis
DWLNR 2525 M08	WN...0804..	25	25	32	150	5009284	€ 107,97	-25%	-50%	-75%	gratis

Wisselplaten kopieerdraaien BC = Boehlerit Copy CNMG 1204.. wisselplaten ER-BC



Wisselplaat	Kwaliteit	L	D	S	R	Artikel	Netto	Illustratie
CNMG 120404 ER-BC	LC435D	12,9	12,7	4,76	0,4	6410871	€ 8,05	
CNMG 120404 ER-BC	LCP25T	12,9	12,7	4,76	0,4	5055854	€ 8,43	
CNMG 120408 ER-BC	LC435D	12,9	12,7	4,76	0,8	6410879	€ 8,05	
CNMG 120408 ER-BC	LCP25T	12,9	12,7	4,76	0,8	5055858	€ 8,43	

DNMG 1506.. wisselplaten ER-BC

Wisselplaat	Kwaliteit	L	D	S	R	Artikel	Netto	Illustratie
DNMG 150604 ER-BC	LC435D	15,5	12,7	6,35	0,4	6400786	€ 11,90	
DNMG 150604 ER-BC	LCP25T	15,5	12,7	6,35	0,4	5055924	€ 12,22	
DNMG 150608 ER-BC	LC435D	15,5	12,7	6,35	0,8	6400788	€ 11,90	
DNMG 150608 ER-BC	LCP25T	15,5	12,7	6,35	0,8	5055928	€ 12,22	

TNMG 1604.. wisselplaten ER-BC

Wisselplaat	Kwaliteit	L	D	S	R	Artikel	Netto	Illustratie
TNMG 160404 ER-BC	LC435D	16,5	9,52	4,76	0,4	6411838	€ 7,39	
TNMG 160404 ER-BC	LCP25T	16,5	9,52	4,76	0,4	5056014	€ 7,78	
TNMG 160408 ER-BC	LC435D	16,5	9,52	4,76	0,8	6410961	€ 7,39	
TNMG 160408 ER-BC	LCP25T	16,5	9,52	4,76	0,8	5056018	€ 7,78	

WNMG 0804.. wisselplaten ER-BC

Wisselplaat	Kwaliteit	L	D	S	R	Artikel	Netto	Illustratie
WNMG 080404 ER-BC	LC435D	8,6	12,7	4,76	0,4	6410972	€ 9,71	
WNMG 080404 ER-BC	LCP25T	8,6	12,7	4,76	0,4	5056067	€ 10,10	
WNMG 080408 ER-BC	LC435D	8,6	12,7	4,76	0,8	6410980	€ 9,71	
WNMG 080408 ER-BC	LCP25T	8,6	12,7	4,76	0,8	5056070	€ 10,10	
WNMG 080412 ER-BC	LC435D	8,6	12,7	4,76	1,2	6411654	€ 9,71	
WNMG 080412 ER-BC	LCP25T	8,6	12,7	4,76	1,2	5056076	€ 10,10	

Volhardmetaal 4-snijder frees 35°/38° AlCrN



Basic Line Plus



Dc	Ds	Lc	Ln	Dn	Lt	c	z	Artikel HB	Bruto	Actie
3,0	6	8	14	2,8	57	0,05	4	BLW4L03038VN	€ 21,81	€ 16,-
3,5	6	10	16	3,3	57	0,05	4	BLW4L03538VN	€ 21,81	€ 16,-
4,0	6	11	16	3,8	57	0,05	4	BLW4L04038VN	€ 21,81	€ 16,-
4,5	6	11	18	4,3	57	0,07	4	BLW4L04538VN	€ 21,81	€ 16,-
5,0	6	13	18	4,8	57	0,10	4	BLW4L05038VN	€ 21,81	€ 16,-
6,0	6	13	19	5,7	57	0,10	4	BLW4L06038VN	€ 21,81	€ 16,-
8,0	8	19	25	7,6	63	0,20	4	BLW4L08038VN	€ 27,45	€ 21,-
10,0	10	22	30	9,5	72	0,25	4	BLW4L10038VN	€ 42,80	€ 32,-
12,0	12	26	36	11,5	83	0,30	4	BLW4L12038VN	€ 53,43	€ 40,-
14,0	14	26	36	13,5	83	0,35	4	BLW4L14038VN	€ 73,95	€ 56,-
16,0	16	32	42	15,5	92	0,40	4	BLW4L16038VN	€ 87,47	€ 66,-
18,0	18	32	42	17,5	92	0,45	4	BLW4L18038VN	€ 114,69	€ 85,-
20,0	20	38	52	19,5	104	0,50	4	BLW4L20038VN	€ 133,26	€ 99,-

Volhardmetaal ruwfrees 45° AlCrN



Basic Line Plus



Dc	Ds	Lc	Ln	Dn	Lt	c	z	Artikel HB	Bruto	Actie
4	6	11	16	3,8	57	0,15	3	BLW3L04045RN	€ 25,88	€ 20,-
5	6	13	18	4,8	57	0,20	4	BLW4L05045RN	€ 25,88	€ 20,-
6	6	13	19	5,7	57	0,30	4	BLW4L06045RN	€ 25,88	€ 20,-
8	8	19	25	7,6	63	0,30	4	BLW4L08045RN	€ 34,38	€ 26,-
10	10	22	30	9,5	72	0,30	4	BLW4L10045RN	€ 46,43	€ 35,-
12	12	26	36	11,5	83	0,30	4	BLW4L12045RN	€ 62,76	€ 47,-
14	14	26	36	13,5	83	0,35	4	BLW4L14045RN	€ 76,26	€ 57,-
16	16	32	42	15,5	92	0,40	4	BLW4L16045RN	€ 102,93	€ 77,-
16	16	32	42	15,5	92	0,40	5	BLW5L16045RN	€ 102,93	€ 77,-
18	18	32	42	17,5	92	0,45	5	BLW5L18045RN	€ 119,97	€ 90,-
20	20	38	52	19,5	104	0,50	5	BLW5L20045RN	€ 157,37	€ 118,-
20	20	38	52	19,5	104	0,50	6	BLW6L20045RN	€ 157,37	€ 118,-

Weldon houder met radiale koelkanalen

SK40

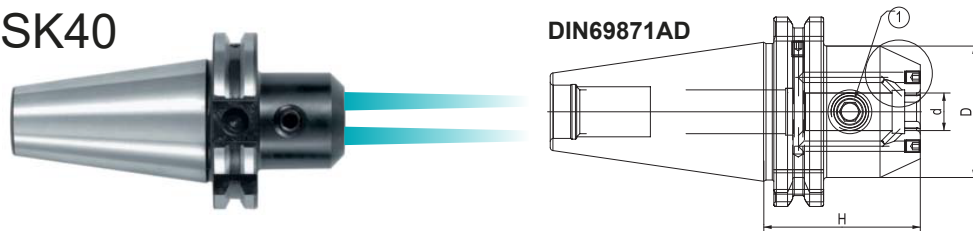

DIN69871AD



Opname	d	H	D	Type	Artikel	Bruto	Actie
SK40	6	50	25	TC40H50WE06-IK	213-61325	€ 85,00	€ 68,-
SK40	8	50	28	TC40H50WE08-IK	213-61326	€ 80,00	€ 64,-
SK40	10	50	35	TC40H50WE10-IK	213-61327	€ 80,00	€ 64,-
SK40	12	50	42	TC40H50WE12-IK	213-61328	€ 80,00	€ 64,-
SK40	14	50	44	TC40H50WE14-IK	213-61329	€ 80,00	€ 64,-
SK40	16	63	48	TC40H63WE16-IK	213-61330	€ 80,00	€ 64,-
SK40	18	63	50	TC40H63WE18-IK	213-61331	€ 80,00	€ 64,-
SK40	20	63	52	TC40H63WE20-IK	213-61332	€ 80,00	€ 64,-
SK40	25	100	63	TC40H100WE25-IK	213-61333	€ 95,00	€ 76,-

Dc = Diameter | Ds = Diameter schacht | Lc = Snijlengte | Ln = Lengte nek | Dn = Diameter nek | Lt = Lengte totaal | c = Fase | Z = Aantal snijkanten

Volhardmetaal 5-snijder frees 37°/38° AlCrN

SLT
TOOLS

Basic Line Plus 2xD

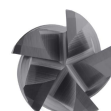

P H K

Dc	Ds	Lc	Ln	Dn	Lt	c	z	Artikel HB	Bruto	Actie
3	6	6	14	2,8	57	0,06	5	BLW5L03038VN	€ 22,20	€ 17,-
4	6	8	16	3,8	57	0,08	5	BLW5L04038VN	€ 22,20	€ 17,-
5	6	10	18	4,8	57	0,10	5	BLW5L05038VN	€ 22,20	€ 17,-
6	6	12	19	5,7	57	0,12	5	BLW5L06038VN	€ 22,20	€ 17,-
8	8	16	25	7,6	63	0,16	5	BLW5L08038VN	€ 28,77	€ 22,-
10	10	20	30	9,5	72	0,20	5	BLW5L10038VN	€ 42,38	€ 33,-
12	12	24	36	11,5	83	0,24	5	BLW5L12038VN	€ 56,07	€ 42,-
14	14	28	36	13,5	83	0,28	5	BLW5L14038VN	€ 76,34	€ 58,-
16	16	32	42	15,5	92	0,32	5	BLW5L16038VN	€ 99,77	€ 75,-
18	18	36	42	17,5	92	0,36	5	BLW5L18038VN	€ 126,78	€ 95,-
20	20	40	52	19,5	104	0,40	5	BLW5L20038VN	€ 153,66	€ 115,-
25	25	50	62	24,0	120	0,50	5	BLW5L25038VN	€ 276,05	€ 209,-

Volhardmetaal 5-snijder frees 41°/42° AlCr

SLT
TOOLS

Basic Line Plus 2xD



M S

Dc	Ds	Lc	Ln	Dn	Lt	c	z	Artikel HB	Bruto	Actie
3	6	6	14	2,8	57	0,06	5	BLW5L03042VN	€ 24,84	€ 19,-
4	6	8	16	3,8	57	0,08	5	BLW5L04042VN	€ 24,84	€ 19,-
5	6	10	18	4,8	57	0,10	5	BLW5L05042VN	€ 24,84	€ 19,-
6	6	12	19	5,7	57	0,12	5	BLW5L06042VN	€ 24,84	€ 19,-
8	8	16	25	7,6	63	0,16	5	BLW5L08042VN	€ 29,88	€ 23,-
10	10	20	30	9,5	72	0,20	5	BLW5L10042VN	€ 43,68	€ 33,-
12	12	24	36	11,5	83	0,24	5	BLW5L12042VN	€ 59,10	€ 44,-
14	14	28	36	13,5	83	0,28	5	BLW5L14042VN	€ 80,03	€ 60,-
16	16	32	42	15,5	92	0,32	5	BLW5L16042VN	€ 107,33	€ 80,-
18	18	36	42	17,5	92	0,36	5	BLW5L18042VN	€ 138,11	€ 99,-
20	20	40	52	19,5	104	0,40	5	BLW5L20042VN	€ 163,58	€ 122,-
25	25	50	62	24,0	120	0,50	5	BLW5L25042VN	€ 292,47	€ 219,-

Weldon houder met radiale koelkanalen

BT40

MAS 403

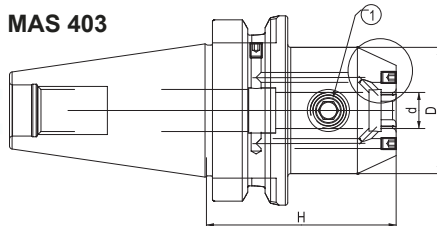

KINTEK
READY, ALWAYS.

Opname	d	H	D	Type	Artikel	Bruto	Actie
BT40	6	50	25	BT40H50WE06-IK	213-61423	€ 85,00	€ 68,-
BT40	8	50	28	BT40H50WE08-IK	213-61424	€ 80,00	€ 64,-
BT40	10	63	35	BT40H63WE10-IK	213-61425	€ 80,00	€ 64,-
BT40	12	63	42	BT40H63WE12-IK	213-61426	€ 80,00	€ 64,-
BT40	14	63	44	BT40H63WE14-IK	213-61427	€ 80,00	€ 64,-
BT40	16	63	48	BT40H63WE16-IK	213-61428	€ 80,00	€ 64,-
BT40	18	63	50	BT40H63WE18-IK	213-61429	€ 80,00	€ 64,-
BT40	20	63	52	BT40H63WE20-IK	213-61430	€ 80,00	€ 64,-
BT40	25	90	63	BT40H90WE25-IK	213-61431	€ 95,00	€ 76,-

Dc = Diameter | Ds = Diameter schacht | Lc = Snijlengte | Ln = Lengte nek | Dn = Diameter nek | Lt = Lengte totaal | c = Fase | Z = Aantal snijkanten

MultiEdge T90 Pro4 tangentialfrees 90°

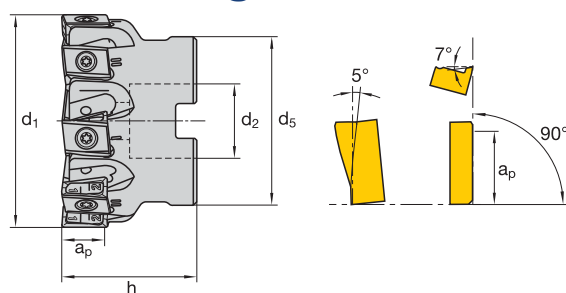

LCP40M	LCKP30M	LCK20M	<div style="border: 1px solid black; padding: 2px; display: inline-block;">P</div> <div style="border: 1px solid black; padding: 2px; display: inline-block;">K</div>
✓	✓	✓	

Combinatiekorting !

U krijgt een flinke korting op deze freesbody, bij aanschaf van LNMU wisselplaten !

Aantal wisselplaten (LNMU)

d1	h	d2	d5	ap	z	Type	Artikel	Bruto	10x	20x	30x	40x
50	40	22	40	11,5	4	FMP90T L13.050AN-I	7167586	€ 372,00	30%	60%	90%	gratis
50	40	22	40	11,5	6	FMP90T L13.050AN-IF	7167587	€ 428,00	25%	50%	75%	gratis
63	40	22	50	11,5	6	FMP90T L13.063AN-I	7167588	€ 484,00	20%	45%	65%	90%
63	40	22	50	11,5	8	FMP90T L13.063AN-IF	7167589	€ 540,00	20%	40%	60%	80%
80	50	27	60	11,5	8	FMP90T L13.080AN-I	7167590	€ 596,00	15%	35%	55%	70%
80	50	27	60	11,5	10	FMP90T L13.080AN-IF	7167591	€ 652,80	15%	30%	50%	65%
100	50	32	65	11,5	10	FMP90T L13.100AN-I	7167592	€ 708,80	15%	30%	45%	60%
100	50	32	65	11,5	12	FMP90T L13.100AN-IF	7167593	€ 764,80	10%	25%	40%	55%
125	63	40	90	11,5	12	FMP90T L13.125AN-I	7167594	€ 824,00	10%	25%	40%	50%
125	63	40	90	11,5	16	FMP90T L13.125AN-IF	7167595	€ 936,00	10%	20%	35%	45%
160	63	40	130	11,5	14	FMP90T L13.160AN	7167596	€ 1048,00	10%	20%	30%	40%
160	63	40	130	11,5	20	FMP90T L13.160AN-F	7167597	€ 1272,00	5%	15%	25%	35%

LNMU 130608 wisselplaten voor MultiEdge T90 Pro4

Wisselplaat	l	d	s	d1	r	Kwaliteit	Artikel	Netto	Illustratie
LNMU 130608 SR	13,5	12,4	6	4,4	0,8	LCP40M	7167537	€ 18,61	
LNMU 130608 SR	13,5	12,4	6	4,4	0,8	LCKP30M	7167538	€ 18,61	
LNMU 130608 SR	13,5	12,4	6	4,4	0,8	LCK20M	7189147	€ 18,61	

Dwarsspie freesopname WSMH met inwendige koelkanalen



SK50
DIN69871AD

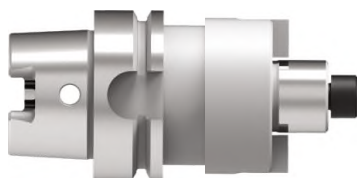

HSK-A100
DIN69893A

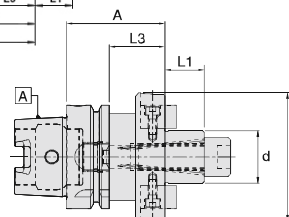
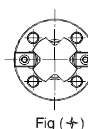
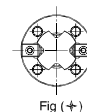
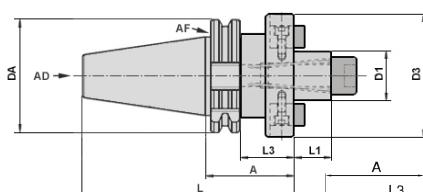

d	D	A	L1	L3	DIN	kg	Type	Artikel	Bruto	Actie
22	48	44	19	24,9	AD/B	3,10	WSMH/22-44/SK50	4601356	€ 114,70	€ 92,-
27	58	44	21	24,9	AD/B	3,35	WSMH/27-44/SK50	4601357	€ 118,40	€ 95,-
32	78	40	24	20,9	AD/B	3,65	WSMH/32-40/SK50	4601358	€ 124,00	€ 99,-
40	88	50	27	30,9	AD/B	5,70	WSMH/40-50/SK50	4601359	€ 138,90	€ 112,-
60	129	70	40	50,9	AD/B	7,80	WSMH/60-70/SK50	4601360	€ 245,50	€ 195,-
d	D	A	L1	L3	DIN	kg	Type	Artikel	Bruto	Actie
22	48	50	19	21	AD	2,50	WSMH/22-50/HSK-A100	4601663	€ 193,45	€ 153,-
27	58	50	21	21	AD	2,80	WSMH/27-50/HSK-A100	4601664	€ 195,90	€ 155,-
32	78	50	24	21	AD	3,10	WSMH/32-50/HSK-A100	4601665	€ 212,05	€ 170,-
40	88	60	27	31	AD	4,00	WSMH/40-60/HSK-A100	4601666	€ 226,90	€ 180,-
60	29	70	40	41	AD	6,15	WSMH/60-70/HSK-A100	5056122	€ 261,65	€ 210,-

THETatec 45N vlakfrees 45° universeel inzetbaar

boehlerit

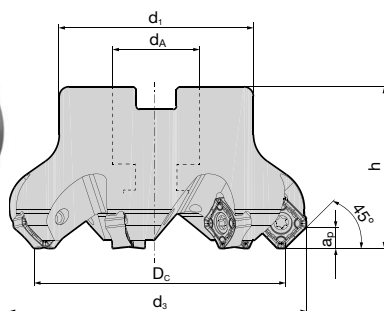
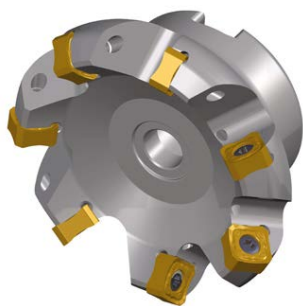

Insert met 8 snijkanten voor hoge snedediepte en productiviteit
 Body met negatieve basisgeometrie, daardoor extreem stabiel
 Effectief positieve snijkantgeometrie voor lichtsnijdend gedrag
 Snijkanten zijn gemarkeerd voor hoge rondloopnauwkeurigheid
 Optionele WIPER geometrie voor hoogste oppervlaktekwaliteit
 Hoog verspanend volume dankzij (zeer) nauwe tandverdeling
 Ongelijke tandsteek voor minder vibratie en rustig freesproces
 Ruime keuze aan snijstoffen, voor diverse materialen optimaal

DC	d3	dA	d1	h	ap	Z	Type	Artikel	Bruto	Actie
50	63,4	22	50	40	6,5	4	BF45 SN12.050 Z04	5079179	€ 287,45	€ 199,-
50	63,4	22	50	40	6,5	6	BF45 SN12.050 Z06	5079186	€ 321,16	€ 225,-
63	76,4	22	50	40	6,5	5	BF45 SN12.063 Z05	5131664	€ 349,10	€ 245,-
63	76,4	22	50	40	6,5	6	BF45 SN12.063 Z06	5079187	€ 363,46	€ 255,-
63	76,4	22	50	40	6,5	8	BF45 SN12.063 Z08	5079188	€ 405,69	€ 285,-
80	93,4	27	60	50	6,5	6	BF45 SN12.080 Z06	5103109	€ 414,11	€ 290,-
80	93,4	27	60	50	6,5	7	BF45 SN12.080 Z07	5079189	€ 422,56	€ 299,-
80	93,4	27	60	50	6,5	10	BF45 SN12.080 Z10	5079190	€ 490,26	€ 345,-
100	113,4	32	80	50	6,5	8	BF45 SN12.100 Z08	5079191	€ 490,26	€ 345,-
100	113,4	32	80	50	6,5	12	BF45 SN12.100 Z12	5079192	€ 574,68	€ 399,-
125	138,4	40	95	63	6,5	8	BF45 SN12.125 Z08	5131666	€ 636,58	€ 450,-
125	138,4	40	95	63	6,5	10	BF45 SN12.125 Z10	5079193	€ 659,29	€ 465,-
125	138,4	40	95	63	6,5	16	BF45 SN12.125 Z16	5079194	€ 819,90	€ 575,-

Diameters DC = 160 / 200 / 250 mm zijn ook leverbaar.

SNMX en SNHX 1206.. wisselplaten voor THETatec 45N

Wisselplaat	Kwaliteit	L	D	S	D1	Artikel	Netto	ISO	Illustratie
SNMX 1206 ANSN-MP	BCP20M	12,7	12,7	5,8	5,2	5092061	€ 11,30	P	
SNMX 1206 ANSN-MP	BCP25M	12,7	12,7	5,8	5,2	5081869	€ 11,30		
SNMX 1206 ANSN-MP	BCP30M	12,7	12,7	5,8	5,2	5081870	€ 11,30		
SNMX 1206 ANSN-MP	BCP35M	12,7	12,7	5,8	5,2	5081011	€ 11,30		
SNMX 1206 ANSN-MM	BCM35M	12,7	12,7	6,2	5,2	5090093	€ 11,30	M	
SNMX 1206 ANSN-MM	BCM40M	12,7	12,7	6,2	5,2	5081872	€ 11,30	M	
SNMX 1206 ANSN-MK	BCK15M	12,7	12,7	5,8	5,2	5081013	€ 11,30	K	
SNMX 1206 ANSN-MK	BCK20M	12,7	12,7	5,8	5,2	5081012	€ 11,30	K	
SNHX 1206 ANFN-MN	BCN10M	12,7	12,7	6,2	5,2	5141461	€ 22,13	N	
SNHX 1206 ANFN-MN	BWN10M	12,7	12,7	6,2	5,2	5141458	€ 19,18	N	
SNMX 1206 ANSN-MS	BCS35M	12,7	12,7	6,2	5,2	5162141	€ 17,94	S	
SNMX 1206 ANSN-MS	BCS40M	12,7	12,7	6,2	5,2	5168101	€ 17,94		

Dwarsspie freesopname MAS BT40 Dubbel Kontakt (BBT)

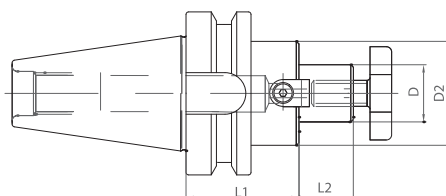

KINTEK
 READY, ALWAYS.

Opname	D	L1	L2	D2	Type	Artikel	Bruto	Actie
BT40 DK	16	45	17	38	BT40H45D16F AD	216-77208	€ 116,00	€ 95,-
BT40 DK	22	45	19	48	BT40H45D22F AD	216-77203	€ 116,00	€ 95,-
BT40 DK	22	60	19	48	BT40H60D22F AD	216-77204	€ 116,00	€ 95,-
BT40 DK	27	45	21	60	BT40H45D27F AD	216-77205	€ 116,00	€ 95,-
BT40 DK	27	60	21	60	BT40H60D27F AD	216-77206	€ 116,00	€ 95,-

Volhardmetaal draadfrees 3xD AlTiZrN



Metrische schroefdraad 60°

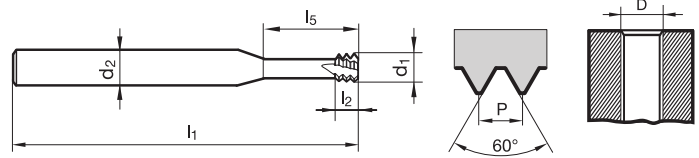

D	P	D1	D2	Dk	L1	L2	L5	Z	Artikel	Bruto	Actie
M1,6	0,35	1,20	3	1,25	39	1,1	4,8	3	5384001600	€ 75,76	€ 60,-
M1,8	0,35	1,40	3	1,45	39	1,1	5,4	3	5384001800	€ 75,76	€ 60,-
M2	0,40	1,55	3	1,60	39	1,2	6,0	4	5384002000	€ 75,76	€ 60,-
M2,5	0,45	1,95	3	2,05	39	1,4	7,5	4	5384002500	€ 75,76	€ 60,-
M3	0,50	2,40	6	2,50	58	1,5	9,5	4	5384003000	€ 78,72	€ 63,-
M3,5	0,60	2,80	6	2,90	58	1,8	11,0	4	5384003500	€ 78,72	€ 63,-
M4	0,70	3,20	6	3,30	58	2,1	12,5	4	5384004000	€ 78,72	€ 63,-
M5	0,80	4,00	6	4,20	58	2,4	16,0	4	5384005000	€ 78,72	€ 63,-
M6	1,00	4,80	6	5,00	58	3,0	20,0	4	5384006000	€ 78,72	€ 63,-
M8	1,25	5,95	6	6,80	58	3,8	24,0	4	5384008000	€ 78,72	€ 63,-
M10	1,50	7,80	8	8,50	73	4,5	33,0	4	5384010000	€ 92,13	€ 74,-
M12	1,75	9,00	10	10,20	84	5,3	38,0	4	5384012000	€ 118,27	€ 96,-
M16	2,00	11,80	12	14,00	84	6,0	35,0	5	5384016000	€ 141,17	€ 112,-

HPH HydroDehn opname HSK-A63 zeer slank 3°



High Performance Holder

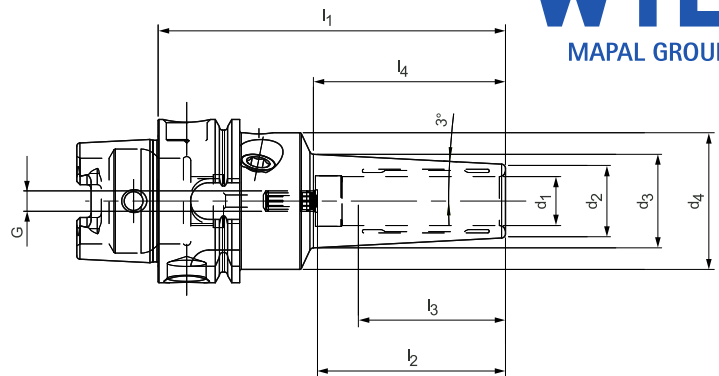

Met axiale instelmogelijkheid m.b.t. gereedschaplenkte

Opname	D1	D2	D3	D4	L1	L2	L3	L4	G	Type	Artikel	Bruto	Actie
HSK-A63	3	9	16,7	50	120	28	16	73	M2,5	16.404.63.03.Z/120	30727351	€ 399,90	€ 333,-
HSK-A63	4	10	17,7	50	120	28	12	73	M2,5	16.404.63.04.Z/120	30727356	€ 399,90	€ 333,-
HSK-A63	5	11	18,7	50	120	28	8	73	M2,5	16.404.63.05.Z/120	30727359	€ 399,90	€ 333,-
HSK-A63	6	12	19,8	50	120	37	10	74	M5	16.404.63.06.Z/120	30655463	€ 399,90	€ 333,-
HSK-A63	7	13	20,8	50	120	37	10	74	M5	16.404.63.07.Z/120	30856764	€ 399,90	€ 333,-
HSK-A63	8	14	21,8	50	120	37	10	74	M6	16.404.63.08.Z/120	30655465	€ 399,90	€ 333,-
HSK-A63	9	15	22,8	50	120	37	10	74	M6	16.404.63.09.Z/120	30856766	€ 399,90	€ 333,-
HSK-A63	10	16	23,8	50	120	41	10	74	M8x1	16.404.63.10.Z/120	30655466	€ 399,90	€ 333,-
HSK-A63	11	17	24,8	50	120	41	10	74	M8x1	16.404.63.11.Z/120	30856768	€ 399,90	€ 333,-
HSK-A63	12	18	25,9	50	120	46	10	75	M10x1	16.404.63.12.Z/120	30655467	€ 399,90	€ 333,-
HSK-A63	13	20	27,9	50	120	46	10	75	M10x1	16.404.63.13.Z/120	30856770	€ 399,90	€ 333,-
HSK-A63	14	22	29,5	50	120	46	10	71	M10x1	16.404.63.14.Z/120	30782387	€ 399,90	€ 333,-
HSK-A63	16	24	31,5	50	120	49	10	71,5	M12x1	16.404.63.16.Z/120	30696274	€ 399,90	€ 333,-
HSK-A63	18	26	33,6	50	120	49	10	72	M12x1	16.404.63.18.Z/120	30696276	€ 399,90	€ 333,-
HSK-A63	20	28	35,6	50	120	51	10	72	M16x1	16.404.63.20.Z/120	30696278	€ 399,90	€ 333,-

Volhardmetaal microfrees TiSiN+ SuperF-UT NX Micro met IK radiaal

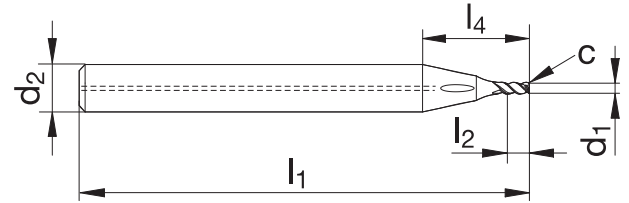
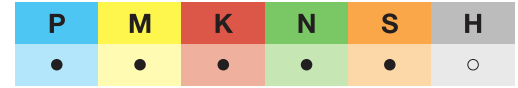

d1	d2	l1	l2	l4	c	Z	Artikel	Bruto	Actie
0,50	4	38	1,250	9,3	0,010	3	5459400500	€ 45,82	€ 37,-
0,75	4	38	1,875	9,3	0,015	3	5459400750	€ 45,82	€ 37,-
0,80	4	38	2,000	9,3	0,016	3	5459400800	€ 45,82	€ 37,-
1,00	4	38	2,500	9,3	0,020	3	5459401000	€ 45,82	€ 37,-
1,20	4	38	3,000	9,4	0,024	3	5459401200	€ 45,82	€ 37,-
1,50	4	45	3,750	9,8	0,030	3	5459401500	€ 45,82	€ 37,-
1,80	4	45	4,500	10,3	0,036	3	5459401800	€ 45,82	€ 37,-
2,00	6	50	5,000	14,7	0,040	3	5459402000	€ 47,38	€ 38,-
2,20	6	50	5,500	14,9	0,044	3	5459402200	€ 47,38	€ 38,-
2,50	6	50	6,250	15,3	0,050	3	5459402500	€ 47,38	€ 38,-
2,80	6	50	7,000	15,9	0,056	3	5459402800	€ 47,38	€ 38,-
3,00	6	50	7,500	16,2	0,060	3	5459403000	€ 47,38	€ 38,-

Afdichtingsprofielen voor uw T-gleuven



Uit ervaring blijkt dat het oppervlak van een machinebed gemiddeld slechts 20% benut wordt. Dat betekent dat 80% ongebruikt blijft, maar wel steeds gereinigd moet worden. Door de T-gleuven daar met een kunststof profiel dicht te maken, kunnen er geen spanen meer in komen. Uw machinebed reinigen gaat zo veel sneller, dus bespaart u structureel tijd in uw proces.

AVM Profi(L)
technologies for tomorrow



Omschrijving	A	L	Artikel	Netto
T-gleuf profiel breedte T14 lengte 1000mm	14	1000	T14/1000	€ 24,40
T-gleuf profiel breedte T18 lengte 1000mm	18	1000	T18/1000	€ 25,18
T-gleuf profiel breedte T22 lengte 1000mm	22	1000	T22/1000	€ 30,30

Afgedichte ER spantangen, compacte set Voor gereedschap met interne koelkanalen

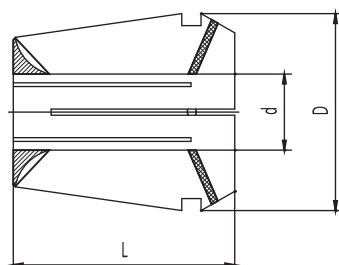

Norm:
DIN 6499 / ISO 15488

Rondloop:
≤ 0,010 mm

Er is ook een uitvoering HP met rondloop: ≤ 0,005 mm
Vraag naar de mogelijkheden !



Type	Afmetingen in set	Stuks	Artikel set	Bruto	Actie
ER16	4-6-8-10	4	SERIE-ER16VG	€ 113,10	€ 90,-
ER20	4-6-8-10-12	5	SERIE-ER20VG	€ 139,90	€ 109,-
ER25	4-6-8-10-12-16	6	SERIE-ER25VG	€ 167,90	€ 129,-
ER32	4-6-8-10-12-16-20	7	SERIE-ER32VG	€ 199,20	€ 159,-
ER40	4-6-8-10-12-16-20-25	8	SERIE-ER40VG	€ 257,40	€ 199,-

Wilt u liever afzonderlijke spantangen bestellen? Op de volgende pagina vindt u al onze ER16-ER40 spantangen van type VG.

Afgedichte ER spantangen

Kintek VG type ≤ 0,010 mm

Specificaties: zie vorige pagina. Ook als set verkrijgbaar!



KINTEK

READY, ALWAYS.

d	D	L	Artikel	Bruto	Actie
3,0	11,35	18	ER11VGD03	€ 36,90	€ 30,-
3,5	11,35	18	ER11VGD03.5	€ 36,90	€ 30,-
4,0	11,35	18	ER11VGD04	€ 36,90	€ 30,-
4,5	11,35	18	ER11VGD04.5	€ 36,90	€ 30,-
5,0	11,35	18	ER11VGD05	€ 36,90	€ 30,-
5,5	11,35	18	ER11VGD05.5	€ 36,90	€ 30,-
6,0	11,35	18	ER11VGD06	€ 36,90	€ 30,-
6,5	11,35	18	ER11VGD06.5	€ 36,90	€ 30,-
7,0	11,35	18	ER11VGD07	€ 36,90	€ 30,-
d	D	L	Artikel	Bruto	Actie
3,0	20,65	31,5	ER20VGD03	€ 26,30	€ 22,-
4,0	20,65	31,5	ER20VGD04	€ 26,30	€ 22,-
5,0	20,65	31,5	ER20VGD05	€ 26,30	€ 22,-
6,0	20,65	31,5	ER20VGD06	€ 26,30	€ 22,-
7,0	20,65	31,5	ER20VGD07	€ 26,30	€ 22,-
8,0	20,65	31,5	ER20VGD08	€ 26,30	€ 22,-
9,0	20,65	31,5	ER20VGD09	€ 26,30	€ 22,-
10,0	20,65	31,5	ER20VGD10	€ 26,30	€ 22,-
11,0	20,65	31,5	ER20VGD11	€ 26,30	€ 22,-
12,0	20,65	31,5	ER20VGD12	€ 26,30	€ 22,-
13,0	20,65	31,5	ER20VGD13	€ 26,30	€ 22,-
d	D	L	Artikel	Bruto	Actie
3,0	32,74	40	ER32VGD03	€ 26,90	€ 22,-
3,5	32,74	40	ER32VGD03.5	€ 28,50	€ 23,-
4,0	32,74	40	ER32VGD04	€ 26,90	€ 22,-
4,5	32,74	40	ER32VGD04.5	€ 28,50	€ 23,-
5,0	32,74	40	ER32VGD05	€ 26,90	€ 22,-
5,5	32,74	40	ER32VGD05.5	€ 28,50	€ 23,-
6,0	32,74	40	ER32VGD06	€ 26,90	€ 22,-
6,5	32,74	40	ER32VGD06.5	€ 28,50	€ 23,-
7,0	32,74	40	ER32VGD07	€ 26,90	€ 22,-
8,0	32,74	40	ER32VGD08	€ 26,90	€ 22,-
8,5	32,74	40	ER32VGD08.5	€ 28,50	€ 23,-
9,0	32,74	40	ER32VGD09	€ 26,90	€ 22,-
9,5	32,74	40	ER32VGD09.5	€ 28,50	€ 23,-
10,0	32,74	40	ER32VGD10	€ 26,90	€ 22,-
10,5	32,74	40	ER32VGD10.5	€ 28,50	€ 23,-
11,0	32,74	40	ER32VGD11	€ 26,90	€ 22,-
11,5	32,74	40	ER32VGD11.5	€ 28,50	€ 23,-
12,0	32,74	40	ER32VGD12	€ 26,90	€ 22,-
12,5	32,74	40	ER32VGD12.5	€ 28,50	€ 23,-
13,0	32,74	40	ER32VGD13	€ 26,90	€ 22,-
14,0	32,74	40	ER32VGD14	€ 26,90	€ 22,-
15,0	32,74	40	ER32VGD15	€ 26,90	€ 22,-
16,0	32,74	40	ER32VGD16	€ 26,90	€ 22,-
17,0	32,74	40	ER32VGD17	€ 26,90	€ 22,-
17,5	32,74	40	ER32VGD17.5	€ 28,50	€ 23,-
18,0	32,74	40	ER32VGD18	€ 26,90	€ 22,-
19,0	32,74	40	ER32VGD19	€ 26,90	€ 22,-
20,0	32,74	40	ER32VGD20	€ 26,90	€ 22,-

d	D	L	Artikel	Bruto	Actie
3,0	16,75	27,5	ER16VGD03	€ 26,30	€ 22,-
4,0	16,75	27,5	ER16VGD04	€ 26,30	€ 22,-
5,0	16,75	27,5	ER16VGD05	€ 26,30	€ 22,-
5,5	16,75	27,5	ER16VGD05.5	€ 26,30	€ 22,-
6,0	16,75	27,5	ER16VGD06	€ 26,30	€ 22,-
7,0	16,75	27,5	ER16VGD07	€ 26,30	€ 22,-
8,0	16,75	27,5	ER16VGD08	€ 26,30	€ 22,-
9,0	16,75	27,5	ER16VGD09	€ 26,30	€ 22,-
10,0	16,75	27,5	ER16VGD10	€ 26,30	€ 22,-
d	D	L	Artikel	Bruto	Actie
3,0	25,6	34	ER25VGD03	€ 26,30	€ 22,-
4,0	25,6	34	ER25VGD04	€ 26,30	€ 22,-
5,0	25,6	34	ER25VGD05	€ 26,30	€ 22,-
6,0	25,6	34	ER25VGD06	€ 26,30	€ 22,-
7,0	25,6	34	ER25VGD07	€ 26,30	€ 22,-
7,5	25,6	34	ER25VGD07.5	€ 26,30	€ 22,-
8,0	25,6	34	ER25VGD08	€ 26,30	€ 22,-
9,0	25,6	34	ER25VGD09	€ 26,30	€ 22,-
10,0	25,6	34	ER25VGD10	€ 26,30	€ 22,-
11,0	25,6	34	ER25VGD11	€ 26,30	€ 22,-
12,0	25,6	34	ER25VGD12	€ 26,30	€ 22,-
13,0	25,6	34	ER25VGD13	€ 26,30	€ 22,-
14,0	25,6	34	ER25VGD14	€ 26,30	€ 22,-
15,0	25,6	34	ER25VGD15	€ 26,30	€ 22,-
16,0	25,6	34	ER25VGD16	€ 26,30	€ 22,-

d	D	L	Artikel	Bruto	Actie
4,0	40,6	46	ER40VGD04	€ 31,30	€ 26,-
5,0	40,6	46	ER40VGD05	€ 31,30	€ 26,-
6,0	40,6	46	ER40VGD06	€ 31,30	€ 26,-
7,0	40,6	46	ER40VGD07	€ 31,30	€ 26,-
8,0	40,6	46	ER40VGD08	€ 31,30	€ 26,-
9,0	40,6	46	ER40VGD09	€ 31,30	€ 26,-
10,0	40,6	46	ER40VGD10	€ 31,30	€ 26,-
11,0	40,6	46	ER40VGD11	€ 31,30	€ 26,-
12,0	40,6	46	ER40VGD12	€ 31,30	€ 26,-
13,0	40,6	46	ER40VGD13	€ 31,30	€ 26,-
14,0	40,6	46	ER40VGD14	€ 31,30	€ 26,-
15,0	40,6	46	ER40VGD15	€ 31,30	€ 26,-
16,0	40,6	46	ER40VGD16	€ 31,30	€ 26,-
17,0	40,6	46	ER40VGD17	€ 31,30	€ 26,-
18,0	40,6	46	ER40VGD18	€ 31,30	€ 26,-
19,0	40,6	46	ER40VGD19	€ 31,30	€ 26,-
20,0	40,6	46	ER40VGD20	€ 31,30	€ 26,-
21,0	40,6	46	ER40VGD21	€ 31,30	€ 26,-
22,0	40,6	46	ER40VGD22	€ 31,30	€ 26,-
23,0	40,6	46	ER40VGD23	€ 31,30	€ 26,-
24,0	40,6	46	ER40VGD24	€ 31,30	€ 26,-
25,0	40,6	46	ER40VGD25	€ 31,30	€ 26,-
26,0	40,6	46	ER40VGD26	€ 31,30	€ 26,-

ECU-Drill-Uni volhardmetaal boor 4xD

M6804 met inwendige koelkanalen

MILLER

MAPAL GROUP

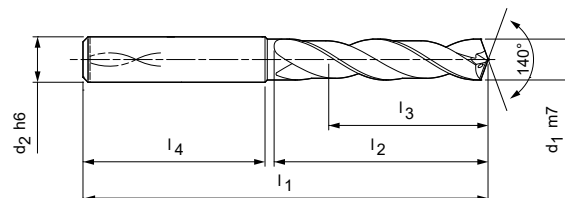
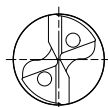

4xD HA HB HE Basic IT9 P 1 2 3 4 5 6 M 1 2 3 K 1 2 3 N 1 2 3 4 S 1 2 3 4 5 H 1 2 3

#	d1	d2	l1	l2	l3	l4	Type	Bruto	Actie / stuk
A	3,00-3,70	6	62	22	16	36	M6804-0300AV t/m M6804-0370AV	€ 33,92	€ 27,-
B	3,80-4,70	6	66	26	22	36	M6804-0380AV t/m M6804-0470AV	€ 36,42	€ 29,-
C	4,80-6,00	6	66	30	24	36	M6804-0480AV t/m M6804-0600AV	€ 36,42	€ 29,-
D	6,10-7,00	8	79	38	30	36	M6804-0610AV t/m M6804-0700AV	€ 50,18	€ 40,-
E	7,10-8,00	8	79	42	34	36	M6804-0710AV t/m M6804-0800AV	€ 50,18	€ 40,-
F	8,10-9,20	10	89	49	38	40	M6804-0810AV t/m M6804-0920AV	€ 56,06	€ 45,-
G	9,30-10,00	10	89	49	40	40	M6804-0930AV t/m M6804-1000AV	€ 56,06	€ 45,-
H	10,10-12,00	12	102	56	45	45	M6804-1010AV t/m M6804-1200AV	€ 80,54	€ 65,-
I	12,20-14,00	14	107	61	50	45	M6804-1220AV t/m M6804-1400AV	€ 112,90	€ 90,-
J	14,20-16,00	16	115	65	51	48	M6804-1420AV t/m M6804-1600AV	€ 137,09	€ 110,-
K	16,50-18,00	18	123	73	53	48	M6804-1650AV t/m M6804-1800AV	€ 220,54	€ 175,-
L	18,50-20,00	20	131	79	55	50	M6804-1850AV t/m M6804-2000AV	€ 240,77	€ 195,-

d1	Artikel	#
3,00	30246405	A
3,10	30246406	A
3,20	30246407	A
3,30	30246408	A
3,40	30246409	A
3,50	30246410	A
3,60	30246411	A
3,70	30246412	A
3,80	30246413	B
3,90	30246414	B
4,00	30246415	B
4,10	30246416	B
4,20	30246417	B
4,30	30246418	B
4,40	30246419	B
4,50	30246420	B
4,60	30246421	B
4,65	30296630	B
4,70	30246422	B
4,80	30246423	C
4,90	30246424	C
5,00	30246425	C
5,10	30246426	C
5,20	30246427	C
5,30	30246428	C
5,40	30246429	C
5,50	30246430	C
5,55	30296631	C
5,60	30246431	C
5,70	30246432	C

d1	Artikel	#
5,80	30246433	C
5,90	30246434	C
6,00	30246435	C
6,10	30246436	D
6,20	30246437	D
6,30	30246438	D
6,40	30246439	D
6,50	30246440	D
6,60	30246441	D
6,70	30246442	D
6,80	30246443	D
6,90	30246444	D
7,00	30246445	D
7,10	30246446	E
7,20	30246447	E
7,30	30246448	E
7,40	30246449	E
7,45	30530768	E
7,50	30246450	E
7,60	30246451	E
7,70	30246452	E
7,80	30246453	E
7,90	30246454	E
8,00	30246455	E
8,10	30246456	F
8,20	30246457	F
8,30	30246458	F
8,40	30246459	F
8,50	30246460	F
8,60	30246461	F

d1	Artikel	#
8,70	30246462	F
8,80	30246463	F
8,90	30246464	F
9,00	30246465	F
9,10	30246466	F
9,20	30246467	F
9,30	30246468	G
9,40	30246469	G
9,50	30246470	G
9,60	30246471	G
9,70	30246472	G
9,80	30246473	G
9,90	30246474	G
10,00	30246475	G
10,10	30294596	H
10,20	30246476	H
10,30	30246477	H
10,40	30294597	H
10,50	30246478	H
10,60	30294598	H
10,70	30294599	H
10,80	30246479	H
10,90	30294600	H
11,00	30246480	H
11,10	30294601	H
11,20	30246481	H
11,50	30246482	H
11,70	30294605	H
11,80	30246483	H
11,90	30294606	H

d1	Artikel	#
12,00	30246484	H
12,20	30246485	I
12,50	30246486	I
12,70	30303991	I
12,80	30246487	I
13,00	30246488	I
13,50	30246489	I
13,80	30246490	I
14,00	30246491	I
14,20	30246492	J
14,50	30246493	J
14,80	30246495	J
15,00	30246496	J
15,10	30246497	J
15,20	30246498	J
15,50	30246499	J
15,70	30328796	J
15,80	30246500	J
16,00	30246501	J
16,50	30246502	K
16,80	30513804	K
17,00	30246503	K
17,30	30246504	K
17,50	30246505	K
17,70	30246506	K
18,00	30246507	K
18,50	30246508	L
19,00	30246509	L
19,50	30246511	L
20,00	30246512	L

HSS-E/PM weldon tap SYNC TiN

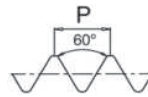

HAHNREITER
GEWINDETECHNIK

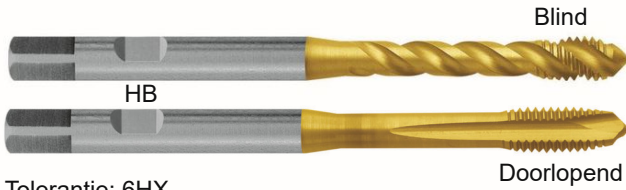

Speciaal voor star tappen (Rigid Tapping) ontwikkeld Schacht met h6 tolerantie, voorzien van Weldon vlak



Tolerantie: 6HX

Gat	D	P	L1	L2	SSP	L3	D2	A	Boor	Norm	Artikel	Bruto	Actie
Blind	M3	0,50	70	7	5	22	6	4,9	2,5	DIN371~	11028703	€ 38,67	€ 31,-
Blind	M4	0,70	70	10	7	30	6	4,9	3,3	DIN371~	11028704	€ 40,02	€ 32,-
Blind	M5	0,80	70	11	8	30	6	4,9	4,2	DIN371~	11028705	€ 42,83	€ 34,-
Blind	M6	1,00	80	14	10	35	6	4,9	5,0	DIN371~	11028706	€ 43,87	€ 35,-
Blind	M8	1,25	90	16	13	40	8	6,2	6,8	DIN371~	11028708	€ 56,13	€ 45,-
Blind	M10	1,50	100	20	14	44	10	8,0	8,5	DIN371~	11028710	€ 69,12	€ 55,-
Blind	M12	1,75	110	19	17	50	12	9,0	10,2	DIN371~	11028712	€ 79,78	€ 64,-
Blind	M14	2,00	110	28	20	56	14	11,0	12,0	DIN371~	11028714	€ 115,90	€ 90,-
Blind	M16	2,00	110	28	20	56	16	12,0	14,0	DIN371~	11028716	€ 119,01	€ 95,-
Blind	M20	2,50	140	32	25		16	12,0	17,5	DIN376	11038720	€ 173,58	€ 136,-
Blind	M24	3,00	160	36	30		18	14,5	21,0	DIN376	11038724	€ 225,55	€ 179,-

Gat	D	P	L1	L2	SSP	L3	D2	A	Boor	Norm	Artikel	Bruto	Actie
Doorlopend	M3	0,50	70	7	5	22	6	4,9	2,5	DIN371~	11028603	€ 34,61	€ 28,-
Doorlopend	M4	0,70	70	10	7	30	6	4,9	3,3	DIN371~	11028604	€ 35,23	€ 29,-
Doorlopend	M5	0,80	70	11	8	30	6	4,9	4,2	DIN371~	11028605	€ 38,05	€ 30,-
Doorlopend	M6	1,00	80	14	10	35	6	4,9	5,0	DIN371~	11028606	€ 38,67	€ 31,-
Doorlopend	M8	1,25	90	16	13	40	8	6,2	6,8	DIN371~	11028608	€ 48,22	€ 39,-
Doorlopend	M10	1,50	100	20	14	44	10	8,0	8,5	DIN371~	11028610	€ 59,76	€ 48,-
Doorlopend	M12	1,75	110	19	17	50	12	9,0	10,2	DIN371~	11028612	€ 69,65	€ 56,-
Doorlopend	M14	2,00	110	28	20	56	14	11,0	12,0	DIN371~	11028614	€ 101,60	€ 80,-
Doorlopend	M16	2,00	110	28	20	56	16	12,0	14,0	DIN371~	11028616	€ 106,54	€ 85,-
Doorlopend	M20	2,50	140	32	25		16	12,0	17,5	DIN376	11038620	€ 153,84	€ 120,-
Doorlopend	M24	3,00	160	36	30		18	14,5	21,0	DIN376	11038624	€ 202,69	€ 160,-

Weldon houder PSC opname ISO 26623-1

KINTEK
READY, ALWAYS.



Met polygoon opname zoals Capto®



Deelcatalogus

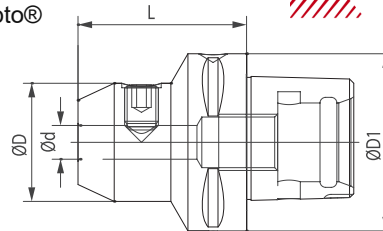

Axiaal aanzicht

ISO	D1	D	d	L	Artikel	Bruto	Voor
C40	40	25	6	50	C40H50WE06	€ 180	€ 144,-
C40	40	28	8	50	C40H50WE08	€ 180	€ 144,-
C40	40	35	10	50	C40H50WE10	€ 180	€ 144,-
C40	40	42	12	55	C40H55WE12	€ 180	€ 144,-
C40	40	48	16	55	C40H55WE16	€ 180	€ 144,-

ISO	D1	D	d	L	Artikel	Bruto	Voor
C63	63	25	6	55	C63H55WE06	€ 179	€ 143,-
C63	63	28	8	55	C63H55WE08	€ 175	€ 140,-
C63	63	35	10	60	C63H60WE10	€ 175	€ 140,-
C63	63	42	12	60	C63H60WE12	€ 175	€ 140,-
C63	63	44	14	60	C63H60WE14	€ 175	€ 140,-
C63	63	48	16	65	C63H65WE16	€ 175	€ 140,-
C63	63	52	20	65	C63H65WE20	€ 175	€ 140,-
C63	63	64	25	80	C63H80WE25	€ 175	€ 140,-
C63	63	72	32	90	C63H90WE32	€ 175	€ 140,-

ISO	D1	D	d	L	Artikel	Bruto	Voor
C50	50	25	6	55	C50H55WE06	€ 183	€ 146,-
C50	50	28	8	55	C50H55WE08	€ 179	€ 143,-
C50	50	35	10	65	C50H65WE10	€ 179	€ 143,-
C50	50	42	12	65	C50H65WE12	€ 179	€ 143,-
C50	50	48	16	65	C50H65WE16	€ 179	€ 143,-
C50	50	52	20	65	C50H65WE20	€ 179	€ 143,-
C50	50	65	25	80	C50H80WE25	€ 179	€ 143,-

ISO	D1	D	d	L	Artikel	Bruto	Voor
C80	80	50	20	70	C80H70WE20	€ 231	€ 186,-
C80	80	52	25	80	C80H80WE25	€ 231	€ 186,-
C80	80	72	32	80	C80H80WE32	€ 231	€ 186,-
C80	80	80	40	110	C80H110WE40	€ 231	€ 186,-

HSS-E/PM roltap 110245 Drückfix N TiN



Tolerantie: 6HX

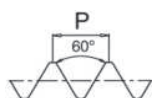

Met smeergroeven

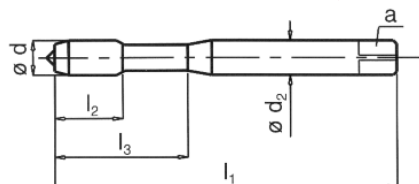

Staffelprijs

Afname: 3+ stuks

d	P	l1	l2	l3	d2	a	Boor	Artikel	Bruto	Actie / stuk
M2	0,4	45	6	10	2,8	2,1	1,85	11024502	€ 54,32	€ 44,-
M2,5	0,45	50	9	14	2,8	2,1	2,3	11024502,5	€ 31,90	€ 26,-
M3	0,5	56	10	18	3,5	2,7	2,8	11024503	€ 31,90	€ 26,-
M3,5	0,6	56	11	20	4	3	3,25	11024503,5	€ 33,15	€ 27,-
M4	0,7	63	12	23	4,5	3,4	3,7	11024504	€ 33,15	€ 27,-
M5	0,8	70	14	25	6	4,9	4,65	11024505	€ 34,19	€ 28,-
M6	1	80	17	30	6	4,9	5,55	11024506	€ 40,64	€ 33,-
M8	1,25	90	18	35	8	6,2	7,4	11024508	€ 46,46	€ 38,-
M10	1,5	100	20	39	10	8	9,3	11024510	€ 59,25	€ 48,-

HSS snelstaal kegelverzinker 90° DIN335C



B051210

HSS



B053210

HSS+TiN

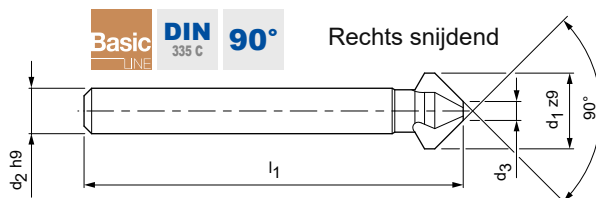

Radiaal vrijgeslepen precisie uitvoering



TiN gecoate uitvoering is ook leverbaar als set: B053220 art. 30359531



d1	d2	d3	l1	z	Artikel	Netto	Artikel TiN	Netto TiN
4,3	4	1,3	40	3	30111110	€ 6,32		
4,8	4	1,5	40	3	30111112	€ 6,32	30117658	€ 11,15
5	4	1,5	40	3	30111114	€ 6,32	30117660	€ 12,03
5,3	4	1,5	40	3	30111116	€ 6,32		
5,8	5	1,5	45	3	30111118	€ 6,51		
6	5	1,5	45	3	30111120	€ 6,51	30117662	€ 12,03
6,3	5	1,5	45	3	30111122	€ 6,51	30117664	€ 12,03
7	6	1,8	50	3	30111124	€ 7,06	30117666	€ 13,90
7,3	6	1,8	50	3	30111126	€ 7,06	30117668	€ 13,90
8	6	2	50	3	30111128	€ 7,06	30117670	€ 13,90
8,3	6	2	50	3	30111130	€ 7,46	30117672	€ 13,90
9,4	6	2,2	50	3	30111132	€ 8,46	30117674	€ 15,46
10	6	2,5	50	3	30111134	€ 8,53	30117676	€ 15,46
10,4	6	2,5	50	3	30111136	€ 8,86	30117678	€ 16,80
11,5	8	2,8	56	3	30111138	€ 9,54	30117680	€ 17,14
12,4	8	2,8	56	3	30111140	€ 9,54	30117682	€ 17,94
13,4	8	2,9	56	3	30111142	€ 10,54		
14,4	8	3	56	3	30111144	€ 10,88		
15	10	3,2	60	3	30111146	€ 10,88	30117684	€ 20,56
16,5	10	3,2	60	3	30111148	€ 11,76	30117686	€ 21,97
19	10	3,5	63	3	30111150	€ 16,06	30117688	€ 28,90
20,5	10	3,5	63	3	30111152	€ 16,40	30117690	€ 29,97
23	10	3,8	67	3	30111154	€ 21,71	30117692	€ 39,10
25	10	3,8	67	3	30111156	€ 21,97	30117694	€ 40,45
26	10	3,8	67	3	30111158	€ 30,85		
28	12	4	71	3	30111160	€ 31,46		
30	12	4,2	71	3	30111162	€ 33,20		
31	12	4,2	71	3	30111164	€ 33,20	30117696	€ 52,54

Volhardmetaal boorruimer 5xD TiAlN

Drill-Reamer-Pyramid | B093505

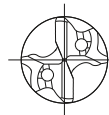

BECK
MAPAL GROUP



Nu met speciale puntgeometrie: een piramidevorm! Dat is de reden dat deze boorruimer zo gemakkelijk in het te bewerken materiaal indringt, met een zeer hoog zelfcenterend vermogen. Twee bewerkingen in één gereedschap: twee borende snijkanten in de punt en vier geleidingsfasen met ruimergeometrie.

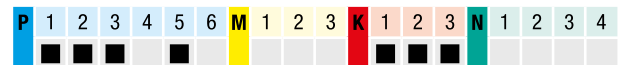
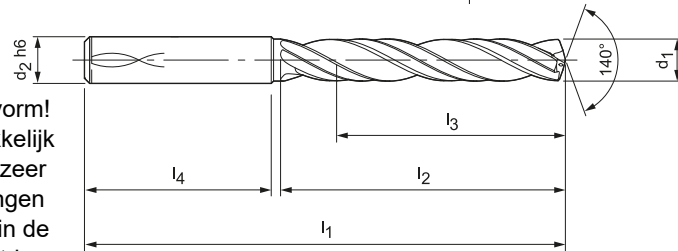

D1	Tol.	D2	L1	L2	L3	L4	Type	Artikel	Bruto	Actie
4,00	H7	6	74	36	29	36	B093505-4.000H7AR	31178666	€ 146,43	€ 119,-
5,00	H7	6	91	53	43	36	B093505-5.000H7AR	31178667	€ 146,43	€ 119,-
6,00	H7	6	91	53	43	36	B093505-6.000H7AR	31178668	€ 146,43	€ 119,-
7,00	H7	8	91	53	43	36	B093505-7.000H7AR	31178669	€ 164,64	€ 129,-
8,00	H7	8	91	53	43	36	B093505-8.000H7AR	31178670	€ 164,64	€ 129,-
9,00	H7	10	103	61	49	40	B093505-9.000H7AR	31178671	€ 164,64	€ 129,-
10,00	H7	10	103	61	49	40	B093505-10.000H7AR	31178672	€ 239,10	€ 192,-
12,00	H7	12	118	71	56	45	B093505-12.000H7AR	31178673	€ 297,76	€ 238,-
14,00	H7	14	124	77	60	45	B093505-14.000H7AR	31178674	€ 402,06	€ 320,-
16,00	H7	16	133	83	63	48	B093505-16.000H7AR	31178675	€ 501,39	€ 398,-

HPH HydroDehn opname Starter-Kit in koffer

WTE
MAPAL GROUP



High Performance Holder

- Hydraulische gereedschapopname
- Uitstekende demping van vibratie(s)
- Eenvoudig en snel manueel spannen
- Buitengewoon lange levensduur
- Thermische stabiliteit tot 170°C
- Minimale spankracht van 550 Nm
- Rondlooptrouwkeurigheid <3 micron

incl. 5 reduceerhulzen en sleutel



Ø 6+8+10+12+16 mm

Ø20

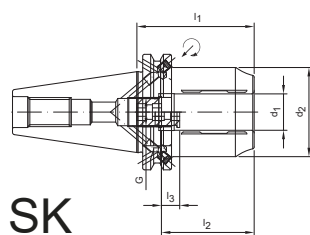

SK

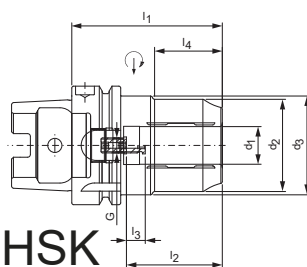

HSK

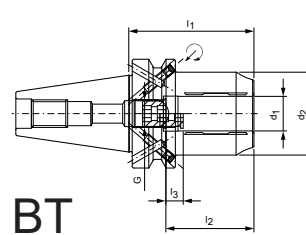

BT

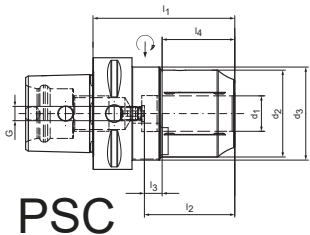

PSC



Opname	D1	D2	D3	L1	L2	L3	L4	G	SW	kg	Type	Artikel	Bruto	Actie
SK40	20	49		64,5	51	10		M16x1	8	1,4	99.408.0002	30645506	€ 502,20	€ 399,-
HSK-A63	20	49	52,5	80	51	10	36	M8x1	3	1,3	99.408.0001	30645501	€ 523,10	€ 420,-
BT40	20	49		72,5	51	10		M16x1	8	1,4	99.408.0003	30645512	€ 502,20	€ 399,-
PSC63	20	49	52,5	80	51	10	41	M8x1	3	1,4	99.408.0008	30965537	€ 692,90	€ 560,-

Spantangopname ER50 met raster 96x96 excl. spanbouten



ER50 voor
Ø 6-34 mm

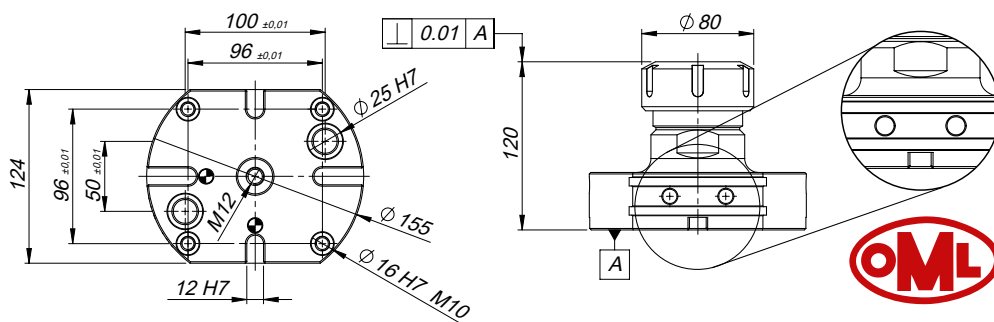

Omschrijving	Artikel	Bruto	Actie
ER50 spanmiddel voor rond product op Plus5 nulpuntplaten met 96x96 mm raster	46233500	€ 546,00	€ 432,-

Spantangopname ER32 met raster 52x52 incl. spanbouten



ER32 voor
Ø 2-20 mm
en NIEUW:
Ø 20,5-25 mm
(OVERSIZE)

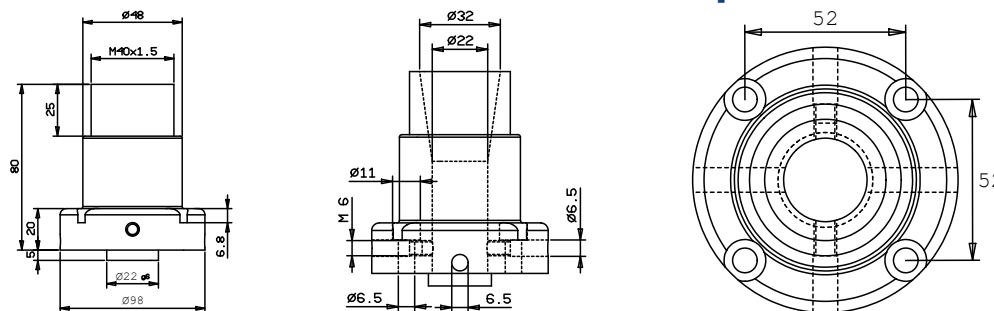

Omschrijving	Artikel	Bruto	Actie
ER32 spanmiddel voor rond product op Plus5 nulpuntplaten met 52x52 mm raster	47232	€ 371,42	€ 290,-

Spanbouten M8 voor raster 52x52 en M10 voor raster 96x96

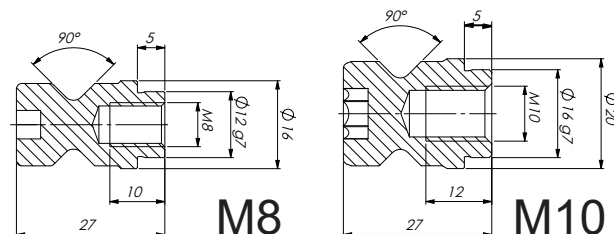

Draad	Omschrijving	Artikel	Netto
M8	Spanbout reguliere uitvoering H27 met passing voor raster 52x52 mm, set van 4 stuks	46240214	€ 60,32
M10	Spanbout reguliere uitvoering H27 met passing voor raster 96x96 mm, set van 4 stuks	46240224	€ 64,48
M8	Spanbout reguliere uitvoering H27 met passing voor raster 52x52 mm, los per stuk	46240210	€ 15,60
M10	Spanbout reguliere uitvoering H27 met passing voor raster 96x96 mm, los per stuk	46240220	€ 16,64

Krimpapparaat ISG3410WK1-11-FS vloeistof gekoeld



PROFESSIONAL uitvoering van Bilz
Spanbereik volhardmetaal: 3-32 mm
Spanbereik HSS snelstaal: 6-32 mm
Inductiespoel: Vast, 4 wisselschijven
Gereedschap lengte: 365-660 mm *
Max. koelbare lengte: 175-350 mm *
Koeling: Vloeistof met droogcyclus
Koelcyclus: 20 sec | Inhoud: 50 liter
Elektra: 400V / 16A / 50 Hz / 11 kW
Perslucht: 4 bar druk is aanbevolen
Breedte: 800 mm | Diepte: 560 mm
Hoogte: 1720 mm | Gewicht: 128 kg

Nu met GRATIS touchscreen
Vraag naar de voorwaarden!



* Afhankelijk van de gereedschapopname
SK40-SK50/BT40-BT50/HSK63-HSK100

Levering: krimpapparaat inclusief vaste inductiespoel 3-32 mm,
4 wisselbare ferrietschijven, corrosiewerend koelmiddel additief
1000 ml voor emulsie tank, handschoenen, gebruikshandleiding

Omschrijving	Type	Artikel	Bruto	Actie
Krimpapparaat, met wisselschijven, watergekoeld	ISG3410WK1-11-FS-BIL	5075418	€ 13.757,80	€ 11.020,-



Hagro

Uw partner in efficiënt produceren

120.000+

PRECISIE GEREEDSCHAPPEN

55

JAAR PRAKTIJKERVARING

20

VAKKUNDIGE MEDEWERKERS

40+

ABSOLUTE TOPMERKEN

ONS LEVERINGSPROGRAMMA



Verspanend Gereedschap

Geschikt voor staal, aluminium, non-ferro, legeringen (hooggelegeerd), kunststof en overige materialen.



Span Gereedschap

"Alles tussen spil en machinebed"
Het spannen van gereedschap en werkstuk is essentieel in uw proces.

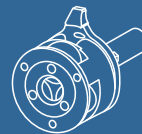

Rol Systemen

Met rolkoppen en -machines kan men alle soorten schroefdraad en profielen enorm snel vervaardigen.



Magazijn Inrichting

Hoogwaardig gereedschap verdient het beste opbergsysteem (van Huni) én nauwkeurige meetinstrumenten.

**BENIEUWD NAAR ONZE MOGELIJKHEDEN
NEEM CONTACT OP**



Hagro Precisie BV

+31 486 462424



Industriepark 18
5374 CM Schaijk

+31 486 461650



www.hagro.nl

hagro@hagro.nl



Uw partner in efficiënt produceren