



*konusulan
the spoken kalite...
quality...*

KARTUŞLAR

KARTUŞLAR
CARTRIDGE
KURZDREHHALTER



S

1

T

2

F

3

C

4

R

5

12

6

C

7

A

8

16

9

1 Sıkma Tipi / Method of Mounting of Insert / Klemmsystem



Deliksiz Üstten Sıkma
Top Clamping Without Hole
Pratzenklammerung

C

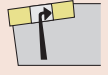

Delikten Levye ile Sıkma
Hole Clamping (Lever Lock)
Kniehebel-Spannsystem

P



Vida ile Sıkma
Screw on
Schrauben-Spannsystem

S

2 Uç Tipi / Type of Insert / Plattenform



C



S



T

3 Yanaşma Açısı / Tool Holder Shape Bar Geometry / Anstellwinkel

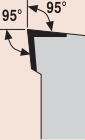

L



S



F

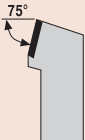

R



K



G



W



T

4 Serbest Uç Açısı / Insert Clearance Angle / Freiwinkel



C



P



N

5 Kesme Yönü / Cutting Direction / Halterausführung

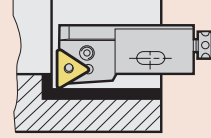

R

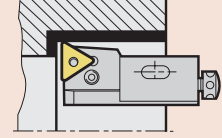

L

6 Kesme Kenar Yüksekliği / Cutting Edge Height / Drehhalterhöhe

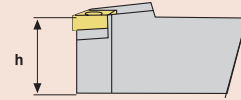

7 Kartuş Kodu / Cartridge Code / Wechselkopfbezeichnung

C
(Kartuş / Cartridge Code / Kurzdrehhalter Bezeichnung)

8 Kartuş Tipi / Cartridge Type / Wechselkopftyp

A
(ISO 5611)

9 Kesme Kenar Uzunluğu / Cutting Edge Length / Halterausführung

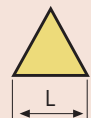

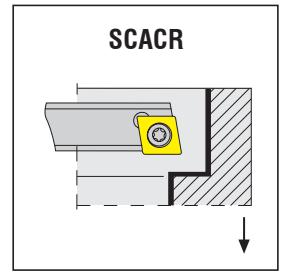
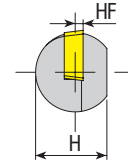
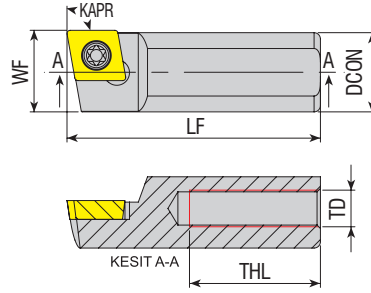

Takım Kodu Ordering Code Bestell-Bezeichnung	Stok Stock Lager		Takım Ölçüleri (mm) Dimension (mm) Abmessung (mm)							Kesici Uç Insert Wendeschneidplatte	Yedek Parçaları / Spare Parts / Ersatzteile	
	R	L	DCON	H	LF	THL	HF	WF	TD		Sıkma Vidası Screw Klemmschraube	Tork Anahtar Torx Key Torx Innensechskantschlüssel
S10X SCACR/L 06	●	●	10	9	25	10	1	10.3	M5x0.8	CC.. 0602..	4008-M2.5x6	82-T08
S10A SCACR/L 06	●	●	10	9	32	15	1	10.3	M5x0.8			
S1018 SCACR/L 06	○	●	10	9	18	8	1	9.8	M5x0.8			
S1065 SCACR/L 06	○	●	10	9	65	25	1	10.3	M5x0.8			
S10C SCACR/L 06	●	●	10	9	50	25	1	10.3	M5x0.8			
S12B SCACR/L 06	●	●	12	11	40	25	1	12.3	M5x0.8			
S12D SCACR/L 06	●	●	12	11	60	25	1	12.3	M5x0.8			
S12D SCACR/L 09	●	●	12	11	60	25	2	12.3	M5x0.8			
S1265 SCACR/L 09	○	●	12	11	65	25	2	12.3	M5x0.8			
S12H SCACR/L 09	●	●	12	11	100	25	2	12.3	M5x0.8			
S15C SCACR/L 09	●	●	15	14	50	25	2	15.3	M8x1.25	CC.. 09T3..	4015-M3.5x8	80-T15
S1554 SCACR/L 09	○	●	15	14	54	25	2	15.3	M8x1.25			
S15E SCACR/L 09	○	●	15	14	70	45	2	15.3	M8x1.25			
S15D SCACR/L 09	○	●	15	14	60	30	2	15.3	M8x1.25			
S16A SCACR/L 09	●	●	16	15	32	15	2	16.5	M6x1			
S16B SCACR/L 09	●	●	16	15	40	20	2	16.5	M6x1			
S16C SCACR/L 09	○	●	16	15	50	25	2	16.5	M6x1			
S16D SCACR/L 09	●	●	16	15	60	30	2	16.5	M6x1			
S16E SCACR/L 09	○	●	16	15	70	30	2	16.5	M6x1			
S16G SCACR/L 09	●	●	16	15	90	30	2	16.5	M6x1			
S16H SCACR/L 09	○	●	16	15	100	35	4	16.5	M6x1			
S1868 SCACR/L 09	○	●	18	17	68	30	2	18.5	M8x1.25	CC.. 1204..	1020-M5x11	80-T20
S18E SCACR/L 09	●	●	18	17	70	30	2	18.5	M8x1.25			
S1888 SCACR/L 09	○	●	18	17	88	30	2	18.5	M8x1.25			
S18105 SCACR/L 09	○	●	18	17	105	30	2	18.5	M8x1.25			
S18175 SCACR/L 09	○	●	18	17	175	30	2	18.5	M8x1.25			
S20E SCACR/L 09	●	●	20	18.3	70	30	2	20.5	M6x1			
S20E SCACR/L 12	●	●	20	18.3	70	30	2	20.5	M6x1			
S20H SCACR/L 12	●	●	20	18.3	100	30	2	20.5	M6x1			

R: Sağ / Right / Rechts L: Sol / Left / Links
● Stokta / In Stock / Auf Lager ○ Stokta Yok / Non Stock Item / Kein Lagerartikel, Lieferzeit auf Anfrage

Sipariş Örneği/Ordering Example/Bestellbeispiel
1 ad./pcs./stück S10X SCACR 06

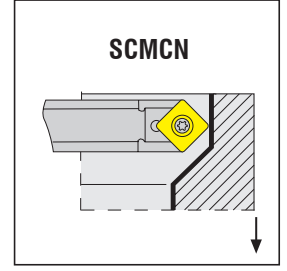
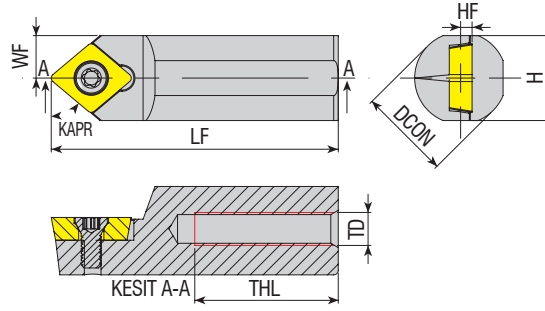

Takım Kodu Ordering Code Bestell-Bezeichnung	Stok Stock Lager	Takım Ölçüleri (mm) Dimension (mm) Abmessung (mm)							Kesici Uç Insert Wendeschneidplatte	Yedek Parçaları / Spare Parts / Ersatzteile	
		DCON	H	LF	THL	HF	WF	TD		Sıkma Vidası Screw Klemmschraube	Tork Anahtar Torx Key Torx Innensechskantschlüssel
S08A SCMCN 06	●	8	7	32	-	2	4	-	CC.. 0602..	4008-M2.5x6	82-T08
S10X SCMCN 06	●	10	9	25	10	1	4.5	M5x0.8			
S10A SCMCN 06	●	10	9	32	15	1	4.5				
S10B SCMCN 06	●	10	9	40	20	1	4.5				
S10C SCMCN 06	●	10	9	50	25	1	4.5				
S10D SCMCN 06	●	10	9	60	25	1	4.5				
S12D SCMCN 06	●	12	11	60	25	1	5.5				
S16C SCMCN 09	●	16	15	50	25	2	7.5	CC.. 09T3..	4015-M3.5x9	80-T15	
S16D SCMCN 09	●	16	15	60	25	4	7.5		4015-M3.5x11		

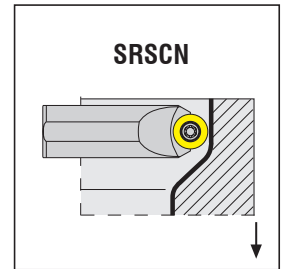
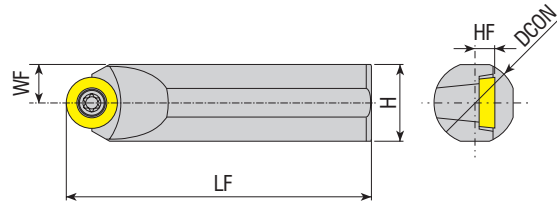

Takım Kodu Ordering Code Bestell-Bezeichnung	Stok Stock Lager	Takım Ölçüleri (mm) Dimension (mm) Abmessung (mm)					Kesici Uç Insert Wendeschneidplatte	Yedek Parçaları / Spare Parts / Ersatzteile	
		DCON	H	WF	HF	LF		Sıkma Vidası Screw Klemmschraube	Tork Anahtar Torx Key Torx Innensechskantschlüssel
S12D SRSCN 10	●	12	11	5.5	3.9	60	RC.. 10T3..	4015-M3.5x9	80-T15
S14D SRSCN 10	●	14	13	6.5	3.9	60		4015-M3.5x11	
S16D SRSCN 10	●	16	15	7.5	3.9	60			

R: Sağ / Right / Rechts L: Sol / Left / Links

● Stokta / In Stock / Auf Lager ○ Stokta Yok / Non Stock Item / Kein Lagerartikel, Lieferzeit auf Anfrage

Sipariş Örneği/Ordering Example/Bestellbeispiel

1 ad./pcs./stück S08A SCMCN 06

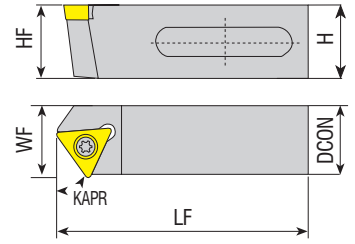

Takım Kodu Ordering Code Bestell-Bezeichnung	Stok Stock Lager		Takım Ölçüleri (mm) Dimension (mm) Abmessung (mm)					Kesici Uç Insert Wendeschneidplatte	Yedek Parçaları / Spare Parts / Ersatzteile		
	R	L	DCON	HF	H	LF	WF		Sıkma Vidası Screw Klemmschraube	Tork Anahtar Torx Key Torx Innensechskantschlüssel	
	○	●									
STXCR/L 2020 B16	○	●	20	20	20	45	20	TC.. 16T3..			
STXCR/L 2020 E16	○	●	20	20	20	70	20				
STXCR/L 2020 B16-SA	○	●	20	10	20	45	20				
STXCR/L 2020 E16-SA	○	●	20	10	20	70	20				
STXCR/L 2020 B16-PL	○	●	20	10	20	45	20				
STXCR/L 2020 E16-PL	○	●	20	10	20	70	20				
STXCR/L 2020 H16-PL	○	●	20	10	20	100	20				

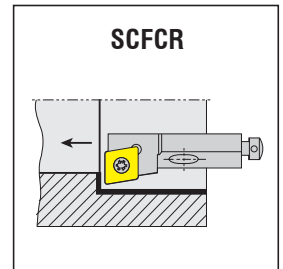
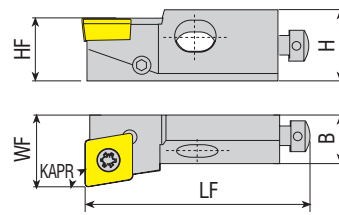
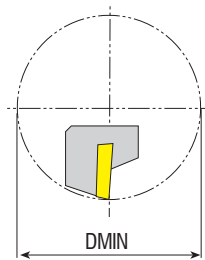

Takım Kodu Ordering Code Bestell-Bezeichnung	Stok Stock Lager		Takım Ölçüleri (mm) Dimension (mm) Abmessung (mm)						Kesici Uç Insert Wendeschneidplatte	Yedek Parçaları / Spare Parts / Ersatzteile			
	R	L	HF	H	B	LF	WF	DMIN		Altlık Shim Unterlage	Altlık Vidası Shim Screw Schraube für Unterlage	Sıkma Vidası Screw Klemmschraube	Tork Anahtar Torx Key Torx Innensechskantschlüssel
	○	●											
SCFCR/L 06CA 06	●	●	6	8.5	6	25	8	≥20	CC.T 060204	-	-	4008-M2.5x6	82-T08
SCFCR/L 08CA 06	●	●	8	11	8	32	10	≥25					
SCFCR/L 10CA 09	●	●	10	15	11	50	14	≥40	CC.T 09T308	-	-	4015-M3.5x9	80-T15
SCFCR/L 12CA 12	●	○	12	20	15	55	20	≥50					
SCFCR/L 16CA 12	●	●	16	21	20	63	25	≥60	CC.T 120408	AACN-2-0003	AAV-10-M4.5x8	4020-M4.5x12	80-T20

R: Sağ / Right / Rechts L: Sol / Left / Links

● Stokta / In Stock / Auf Lager ○ Stokta Yok / Non Stock Item / Kein Lagerartikel, Lieferzeit auf Anfrage

Sipariş Örneği/Ordering Example/Bestellbeispiel

1 ad./pcs./stück STXCR 2020 B16



KAPR=95°

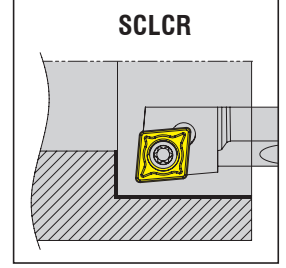
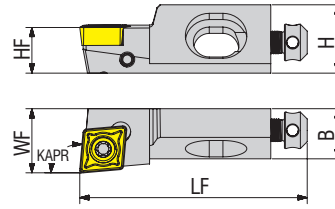
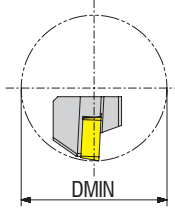

Takım Kodu Ordering Code Bestell-Bezeichnung	Stok Stock Lager		Takım Ölçüleri (mm) Dimension (mm) Abmessung (mm)					Kesici Uç Insert Wendeschneidplatte	Yedek Parçaları / Spare Parts / Ersatzteile				
	R	L	HF	H	B	LF	WF		DMIN	Altlık Shim Unterlage	Altlık Vidası Shim Screw Schraube für Unterlage	Sıkma Vidası Screw Klemmschraube	Tork Anahtar Torx Key Torx Innensechskantschlüssel
SCLCR/L 08CA 06	●	○	8	11	7.5	32	10	≥25	CC.T 060204	-	-	4008-M2.5x6	82-T08
SCLCR/L 10CA 09	●	○	10	15	11	50	14	≥40	CC.T 09T308	-	-	4015-M3.5x9	80-T15
SCLCR/L 12CA 09	●	○	12	20	15	55	20	≥50	CC.T 120408	-	-	4015-M3.5x11	80-T15
SCLCR/L 12CA 12	●	○	12	20	15	55	20	≥50	CC.T 120408	-	-	1020-M5x11	80-T20

ISO Ucuna Uygundur. / Compatible with ISO Insert. / Kompatibel mit ISO Wendeplatten.

KAPR=45°

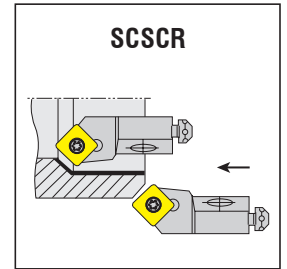
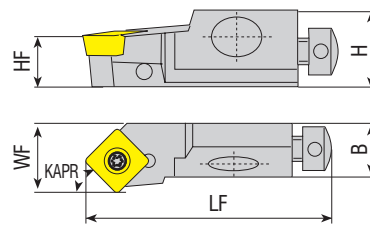
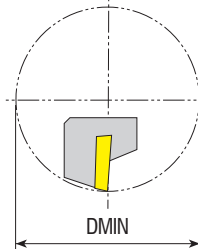

Takım Kodu Ordering Code Bestell-Bezeichnung	Stok Stock Lager		Takım Ölçüleri (mm) Dimension (mm) Abmessung (mm)					Kesici Uç Insert Wendeschneidplatte	Yedek Parçaları / Spare Parts / Ersatzteile				
	R	L	HF	H	B	LF	WF		DMIN	Altlık Shim Unterlage	Altlık Vidası Shim Screw Schraube für Unterlage	Sıkma Vidası Screw Klemmschraube	Tork Anahtar Torx Key Torx Innensechskantschlüssel
SCSCR/L 06CA 06	●	○	6	8	6	30	8	≥20	CC.T 060204	-	-	4008-M2.5x6	82-T08
SCSCR/L 10CA 09	●	○	10	15	11	50	14	≥40	CC.T 09T308	-	-	4015-M3.5x9	80-T15
SCSCR/L 12CA 12	○	○	12	20	15	55	20	≥50	CC.T 120408	-	-	1020-M5x11	80-T20

R: Sağ / Right / Rechts L: Sol / Left / Links

● Stokta / In Stock / Auf Lager ○ Stokta Yok / Non Stock Item / Kein Lagerartikel, Lieferzeit auf Anfrage

Sipariş Örneği/Ordering Example/Bestellbeispiel

1 ad./pcs./stück SCLCR 08CA 06

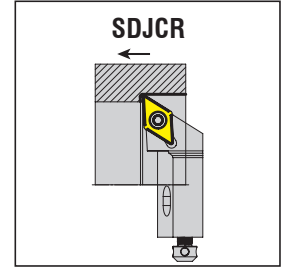
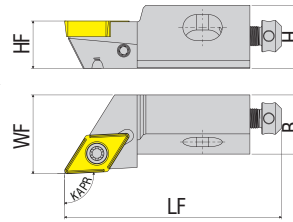
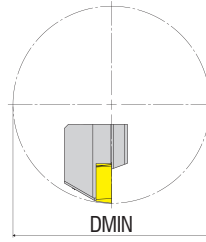

Takım Kodu Ordering Code Bestell-Bezeichnung	Stok Stock Lager		Takım Ölçüleri (mm) Dimension (mm) Abmessung (mm)					Kesici Uç Insert Wendeschneidplatte	Yedek Parçaları / Spare Parts / Ersatzteile				
	R	L	HF	H	B	LF	WF		DMIN	Altlık Shim Unterlage	Altlık Vidası Shim Screw Schraube für Unterlage	Sıkma Vidası Screw Klemmschraube	Tork Anahtar Torx Key Torx Innensechskantschlüssel
SDJCR/L 10CA 07	●	○	10	15	11	50	14	≥40					
SDJCR/L 12CA 11	●	○	12	16	15	55	20	≥50		-	-	4008-M2.5x6	82-T08
												4015-M3.5x10	80-T15

ISO Ucuna Uygunur. / Compatible with ISO Insert. / Kompatibel mit ISO Wendeplatten.

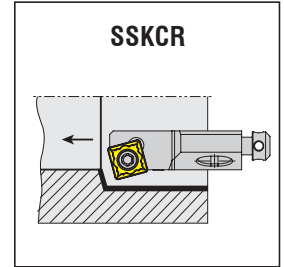
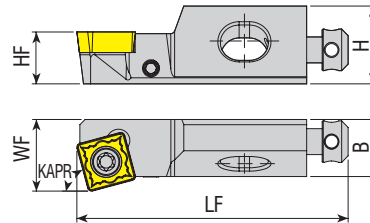
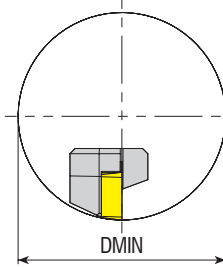

Takım Kodu Ordering Code Bestell-Bezeichnung	Stok Stock Lager		Takım Ölçüleri (mm) Dimension (mm) Abmessung (mm)					Kesici Uç Insert Wendeschneidplatte	Yedek Parçaları / Spare Parts / Ersatzteile				
	R	L	HF	H	B	LF	WF		DMIN	Altlık Shim Unterlage	Altlık Vidası Shim Screw Schraube für Unterlage	Sıkma Vidası Screw Klemmschraube	Tork Anahtar Torx Key Torx Innensechskantschlüssel
SSKCR/L 10CA 09	●	○	10	15	11	50	14	≥40					
SSKCR/L 12CA 12	●	○	12	20	15	55	20	≥50		-	-	4015-M3.5x9	80-T15
												1020-M5x11	80-T20

R: Sağ / Right / Rechts L: Sol / Left / Links

● Stokta / In Stock / Auf Lager ○ Stokta Yok / Non Stock Item / Kein Lagerartikel, Lieferzeit auf Anfrage

Sipariş Örneği/Ordering Example/Bestellbeispiel

1 ad./pcs./stück SDJCR 10CA 07

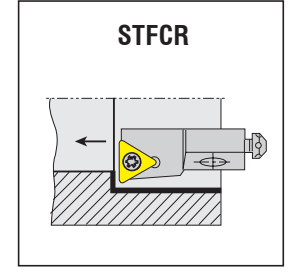
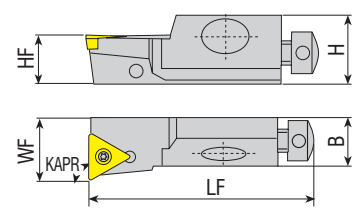
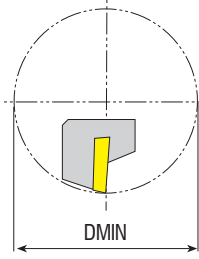

Takım Kodu Ordering Code Bestell-Bezeichnung	Stok Stock Lager		Takım Ölçüleri (mm) Dimension (mm) Abmessung (mm)					Kesici Uç Insert Wendeschneidplatte	Yedek Parçaları / Spare Parts / Ersatzteile				
	R	L	HF	H	B	LF	WF		DMIN	Altlık Shim Unterlage	Altlık Vidası Shim Screw Schraube für Unterlage	Sıkma Vidası Screw Klemmschraube	Tork Anahtar Torx Key Torx Innensechskantschlüssel
STFCR/L 08CA 09	●	●	8	11	8	32	10	≥25	TC.T 090204	-	-	3007-M2.2x4.6	82-T07
STFCR/L 10CA 11	●	●	10	15	11	50	14	≥40	TC.T 110204	-	-	4008-M2.5x6	82-T08
STFCR/L 12CA 16	●	○	12	20	15	55	20	≥50	TC.T 16T308	-	-	4015-M3.5x11	80-T15
STFCR/L 16CA 16	●	●	16	21	20	63	25	≥60		AATN-2-0001	AAV-06-M3.5x11	4015-M3.5x14	

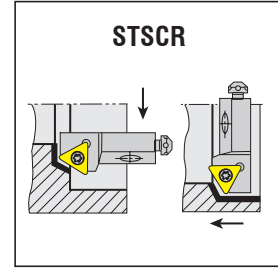
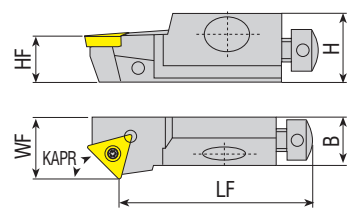
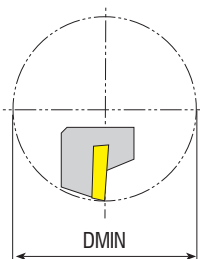

Takım Kodu Ordering Code Bestell-Bezeichnung	Stok Stock Lager		Takım Ölçüleri (mm) Dimension (mm) Abmessung (mm)					Kesici Uç Insert Wendeschneidplatte	Yedek Parçaları / Spare Parts / Ersatzteile				
	R	L	HF	H	B	LF	WF		DMIN	Altlık Shim Unterlage	Altlık Vidası Shim Screw Schraube für Unterlage	Sıkma Vidası Screw Klemmschraube	Tork Anahtar Torx Key Torx Innensechskantschlüssel
STSCR/L 08CA 09	●	○	8	11	8	28	10	≥25	TC.T 090204	-	-	3007-M2.2x4.6	82-T07
STSCR/L 10CA 11	●	●	10	15	11	44	14	≥40	TC.T 110204	-	-	4008-M2.5x6	82-T08
STSCR/L 12CA 16	●	○	12	20	15	47	20	≥50	TC.T 16T308	-	-	4015-M3.5x11	80-T15

R: Sağ / Right / Rechts L: Sol / Left / Links

● Stokta / In Stock / Auf Lager ○ Stokta Yok / Non Stock Item / Kein Lagerartikel, Lieferzeit auf Anfrage

Sipariş Örneği/Ordering Example/Bestellbeispiel

1 ad./pcs./stück STFCR 08CA 09

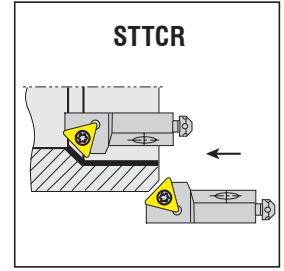
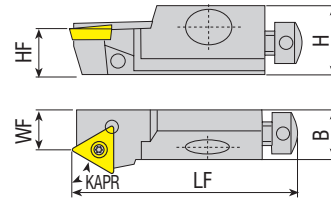
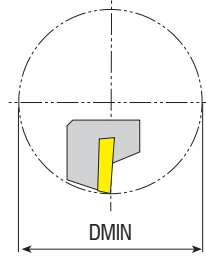

Takım Kodu Ordering Code Bestell-Bezeichnung	Stok Stock Lager		Takım Ölçüleri (mm) Dimension (mm) Abmessung (mm)					Kesici Uç Insert Wendeschneidplatte	Yedek Parçaları / Spare Parts / Ersatzteile				
	R	L	HF	H	B	LF	WF		DMIN	Altlık Shim Unterlage	Altlık Vidası Shim Screw Schraube für Unterlage	Sıkma Vidası Screw Klemmschraube	Tork Anahtar Torx Key Torx Innensechskantschlüssel
STTCR/L 08CA 09	●	●	8	11	8	32	6	≥25	TC.T 090204	-	-	3007-M2.2x4.6	82-T07
STTCR/L 10CA 11	●	●	10	15	11	50	9	≥40	TC.T 110204	-	-	4008-M2.5x6	82-T08
STTCR/L 12CA 16	●	○	12	20	14.8	55	20	≥50	TC.T 16T308	-	-	4015-M3.5x9	80-T15

R: Sağ / Right / Rechts L: Sol / Left / Links

● Stokta / In Stock / Auf Lager ○ Stokta Yok / Non Stock Item / Kein Lagerartikel, Lieferzeit auf Anfrage

Sipariş Örneği/Ordering Example/Bestellbeispiel

1 ad./pcs./stück STTCR 08CA 09



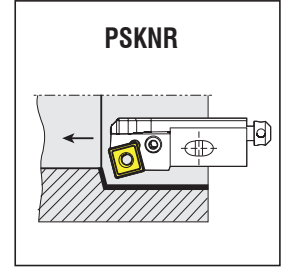
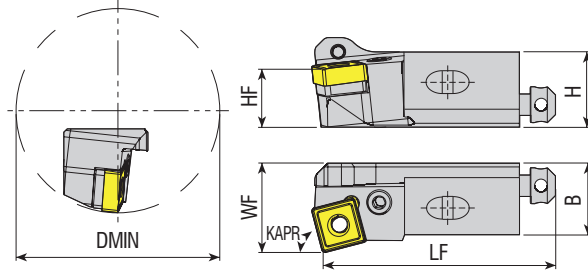

Takım Kodu Ordering Code Bestell-Bezeichnung	Stok Stock Lager		Takım Ölçüleri (mm) Dimension (mm) Abmessung (mm)					Kesici Uç Insert Wendeschneidplatte	Yedek Parçaları / Spare Parts / Ersatzteile					
	R	L	HF	H	B	LF	WF		DMIN	Levyeye Lever Kniehebel	Levyeye Vidası Lever Screw Kniehebelschraube	Altılık Shim Unterlage	Altılık Yayı Shim Spring Feder für Unterlage	Anahtar Allen Key Innensechskantschlüssel
PSKNR/L 16CA 12	●	●	16	21	20	63	25	≥60						
new PSKNR/L 20CA 15	●	●	20	30	20	70	25	-						

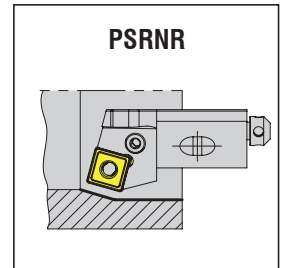
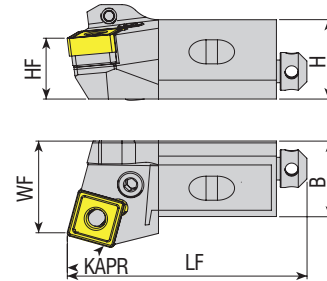
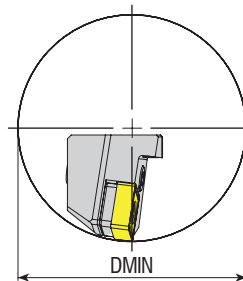

Takım Kodu Ordering Code Bestell-Bezeichnung	Stok Stock Lager		Takım Ölçüleri (mm) Dimension (mm) Abmessung (mm)					Kesici Uç Insert Wendeschneidplatte	Yedek Parçaları / Spare Parts / Ersatzteile					
	R	L	HF	H	B	LF	WF		DMIN	Levyeye Lever Kniehebel	Levyeye Vidası Lever Screw Kniehebelschraube	Altılık Shim Unterlage	Altılık Yayı Shim Spring Feder für Unterlage	Anahtar Allen Key Innensechskantschlüssel
PSRNR/L 16CA 12	○	●	16	21	20	63	25	≥60						

R: Sağ / Right / Rechts L: Sol / Left / Links

● Stokta / In Stock / Auf Lager ○ Stokta Yok / Non Stock Item / Kein Lagerartikel, Lieferzeit auf Anfrage

Sipariş Örneği/Ordering Example/Bestellbeispiel

1 ad./pcs./stück PSKNR 16CA 12

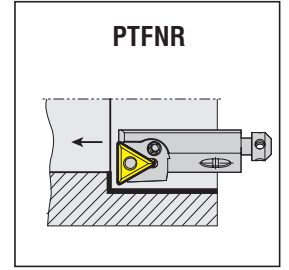
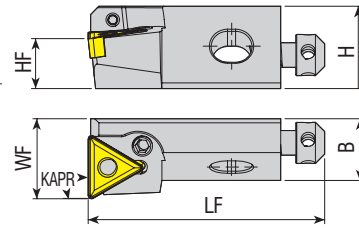
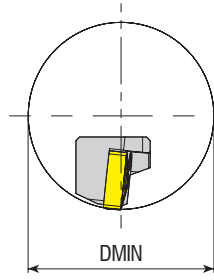

Takım Kodu Ordering Code Bestell-Bezeichnung	Stok Stock Lager		Takım Ölçüleri (mm) Dimension (mm) Abmessung (mm)						Kesici Uç Insert Wendeschneidplatte	Yedek Parçaları / Spare Parts / Ersatzteile				
	R	L	HF	H	B	LF	WF	DMIN		Levyé Lever Kniehebel	Levyé Vidası Lever Screw Kniehebelschraube	Altılık Shim Unterlage	Altılık Yayı Shim Spring Feder für Unterlage	Anahtar Allen Key Innerschraubschlüssel
PTFNR/L 12CA 16	●	●	12	20	15	47	20	≥50	TNM.160408	APL-08	ALV-07-M6x13	-	AAV-07	AAL-02-2.5
PTFNR/L 16CA 16	●	○	16	21	20	63	25	≥60		APL-01	ALV-01-M6x14	AATN-3-0025	AAV-01	
PTFNR/L 16CA 22	○	●	16	21	20	63	25	≥60	TNMG 2204.	APL-02	ALV-03-M8x19	AATN-3-0015	AAV-02	AAL-03-3
PTFNR/L 20CA 22	●	○	20	30	20	63	25	≥70						

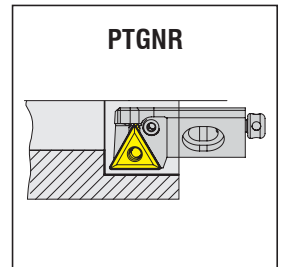
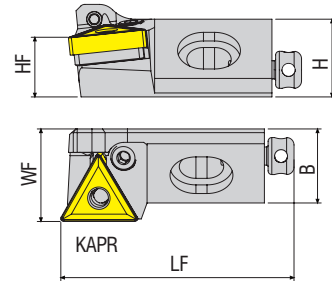
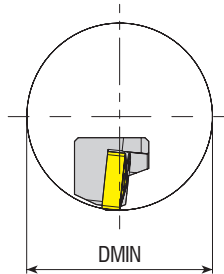

Takım Kodu Ordering Code Bestell-Bezeichnung	Stok Stock Lager		Takım Ölçüleri (mm) Dimension (mm) Abmessung (mm)						Kesici Uç Insert Wendeschneidplatte	Yedek Parçaları / Spare Parts / Ersatzteile				
	R	L	HF	H	B	LF	WF	DMIN		Levyé Lever Kniehebel	Levyé Vidası Lever Screw Kniehebelschraube	Altılık Shim Unterlage	Altılık Yayı Shim Spring Feder für Unterlage	Anahtar Allen Key Innerschraubschlüssel
PTGNR/L 16CA 22	●	●	16	21	20	63	25	60	TNMG 2204..	APL-02	ALV-03-M8x19	AATN-3-0015	AAV-02	AAL-03-3

R: Sağ / Right / Rechts L: Sol / Left / Links

● Stokta / In Stock / Auf Lager ○ Stokta Yok / Non Stock Item / Kein Lagerartikel, Lieferzeit auf Anfrage

Sipariş Örneği/Ordering Example/Bestellbeispiel

1 ad./pcs./stück PTFNR 12CA 16

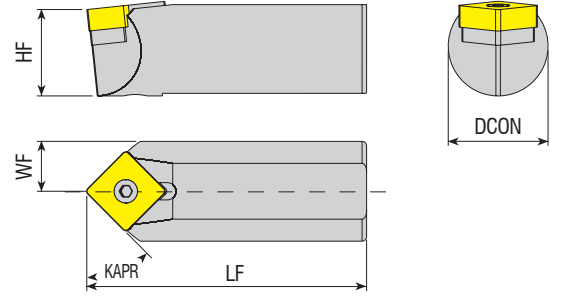

Takım Kodu Ordering Code Bestell-Bezeichnung	Stok Stock Lager	Takım Ölçüleri (mm) Dimension (mm) Abmessung (mm)				Kesici Uç Insert Wendeschneidplatte	Yedek Parçaları / Spare Parts / Ersatzteile				
		DCON	HF	LF	WF		Aitlik Shim Unterlage	Sıkma Vidası Screw Klemmschraube	Baskı Parçası Wedge Clamp Spannpratze	Baskı Vidası Clamp Screw Klemmschraube	Anahtar Allen Key Innensechskantschlüssel
S22D PSDNN 12C	●	22	17.5	65	11						
						SN.. 1204..	AASN-20020	AEV-01-M6x16	ACK-05	4015-M4x11	AAL-02-2.5

R: Sağ / Right / Rechts L: Sol / Left / Links

● Stokta / In Stock / Auf Lager ○ Stokta Yok / Non Stock Item / Kein Lagerartikel, Lieferzeit auf Anfrage

Sipariş Örneği/Ordering Example/Bestellbeispiel

1 ad./pcs./stück S22D PSDNN 12C

KARTUŞLARIN YEDEK PARÇALARI

SPARE PARTS OF CARTRIDGE

ERSATZTEILE FÜR KURZDREHHALTER

Takım Kodu Ordering Code Bestell-Bezeichnung	Yedek Parçaları / Spare Parts / Ersatzteile					
	Eksenel Ayar Vida Axial Adj. Screw Axial-Einstellschraube	Radyal Ayar Vida Radial Adj. Screw Radial-Einstellschraube	Radyal Ayar Vida Anahtar Radial Adj. Screw Allen Key Innensechskantschlüssel für Radial-Einstellschraube	Montaj Vida Mounting Screw Befestigungsschraube	Montaj Vida Anahtar Mounting Screw Allen Key Innensechskantschlüssel für Befestigungsschraube	
SCFCR/L	06CA 06	2600-M4x9.5	2715-M3x5	AAL-09-1.5	AKV-23-M4x10	82-T15
SCSCR/L	08CA 06	2600-M4x9.5	2715-M3x5	AAL-09-1.5	AKV-23-M4x10	82-T15
SSKCR/L	10CA 09	2600-M5x13	2702-M4x10	AAL-01-2	2505-M6x16	AAL-03-3
	12CA 12	2600-M5x13	2702-M4x10	AAL-01-2	2505-M6x16	AAL-03-3
	16CA 12	2600-M6x18	2725-M5x12	AAL-02-2.5	2005-M8x25	AAL-07-5
STSCR/L	08CA 09	2600-M4x9.5	2715-M3x5	AAL-09-1.5	AKV-23-M4x10	82-T15
STTCR/L	10CA 11	2600-M5x13	2702-M4x10	AAL-01-2	2505-M6x16	AAL-03-3
STFCR/L	12CA 16	2600-M5x13	2702-M4x10	AAL-01-2	2505-M6x16	AAL-03-3
	16CA 16	2600-M6x18	2725-M5x12	AAL-02-2.5	2005-M8x25	AAL-07-5
PTFNR/L	12CA 16	2600-M5x13	2702-M4x4	AAL-01-2	2505-M6x16	AAL-03-3
PSKNR/L	16CA 16	2600-M6x18	2725-M5x6	AAL-02-2.5	2005-M8x25	AAL-07-5
PSRNR/L	16CA 12	2600-M6x18	2725-M5x6	AAL-02-2.5	2005-M8x25	AAL-07-5



Takım Kodu Ordering Code Bestell-Bezeichnung	Stok Stock Lager	Ölçü Aralığı (mm) Boring Range (mm) Bohrbereich (mm)					Kartuşlar Cartridge Kurzdrehhalter	Gövde Takım Kodu Body Tool Code Grundkörper-Bezeichnung	Teknik Çizim Technical Draw Technische Zeichnung
		D max		D min		Max (D dış-D iç) (D out-D in)			
		D iç D in	D dış D out	D iç D in	D dış D out				
ACPBT-1	●	27-52	52	18-36	36	27	ÖTG-K-120-20		
ACPBT-2	●	27-49	52	25-36	36	27			
ACPBT-3	●	48-75	75	41	42	27			
ACPBT-4	●	51-75	75	51	52	27			
ACPBT-5	●	22-35	35	22	23	27			
ACPBT-6	●	15-35	35	15	16	27			
ACPBT-7	●	49-53	75	32-36	36	27			
ACPBT-8	●	49	75	33-37	37	27			

Takım Kodu Ordering Code Bestell-Bezeichnung	Stok Stock Lager	Ölçü Aralığı (mm) Boring Range (mm) Bohrbereich (mm)					Kartuşlar Cartridge Kurzdrehhalter	Gövde Takım Kodu Body Tool Code Grundkörper-Bezeichnung	Teknik Çizim Technical Draw Technische Zeichnung
		D1		D2		Max (D dış-D iç) (D out-D in)			
		D max	D min	D max	D min				
ACPBT-9	●	38	24	15	1	-	ÖTG-K-120-20		
ACPBT-10	●	78	64	43	29	-			

R: Sağ / Right / Rechts L: Sol / Left / Links

● Stokta / In Stock / Auf Lager ○ Stokta Yok / Non Stock Item / Kein Lagerartikel, Lieferzeit auf Anfrage

Sipariş Örneği / Ordering Example / Bestellbeispiel

1 ad./pcs./stück ACPBT-1