



*konusulan  
the spoken kalite...  
quality...*

# S-SİSTEM

**S-SİSTEM DELİK TORNA KATERLERİ**  
*S-SYSTEM BORING BARS*  
*S-SYSTEM BOHRSTANGE*



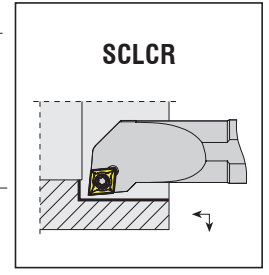
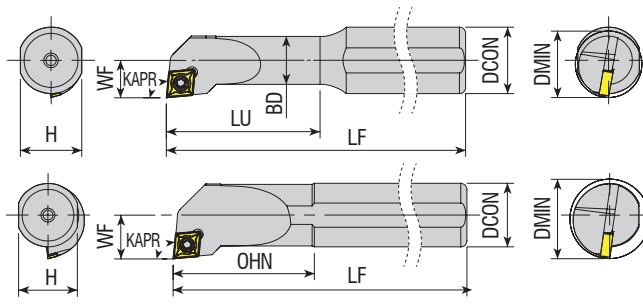

Yedek Parçaları / Spare Parts / Ersatzteile

Takım Kodu  
Ordering Code  
Bestell-Bezeichnung

Stok Stock Lager	Takım Ölçüleri (mm) Dimension (mm) Abmessung (mm)								Kesici Uç Insert Wendeschneidplatte	Yedek Parçaları / Spare Parts / Ersatzteile					
	R	L	DCON	BD	H	LU=OHN	LF	WF		DMIN	Sıkma Vidası Screw Klemmschraube	Altlık Shim Unterlage	Altlık Vidası Shim Screw Schraube für Unterlage	Tork Anahtar Torx Key Torx/Innenschlantschlüssel	
	○		08	5	7.3	18	100	3	≥6	CC.. 0301..				82-T06	
	●	●	08	6	7.3	25	100	4.5	≥8	CC.. 0602..				82-T08	
	●	●	08	8	7.3	20	100	06	≥11		4008-M2.5x4.5				
new	●	●	8	7.5	7.3	20	125	6	≥11		4008-M2.5x5	-	-		
new	●	●	8	7.5	7.3	20	150	6	≥11		4008-M2.5x5				
	●	●	10	10	09	25	125	07	≥13		4008-M2.5x6				
	●	●	12	12	11	25	125	09	≥16						
	●	●	16	16	14.8	37	170	09	≥16		4008-M2.5x6				
	●	●	16	16	14.8	35	170	11	≥20						
	●	●	12	12	11	30	125	09	≥16	CC.. 09T3..				80-T15	
new	●	●	12	11.5	11	30	150	9	≥16	4015-M3.5x9	-	-			
	●	●	16	14	14.8	45	170	9.5	≥17						
	●	●	16	16	14.8	35	170	11	≥20	4015-M3.5x12	AACN-2-0001	AAV-08-M3.5x8			
	●	●	20	16	18.3	50	200	11	≥20						
new	●	●	16	15.5	14.8	35	200	11	≥20	4015-M3.5x9					
	●	●	20	20	18.3	40	200	13	≥25		AACN-2-0003	AAV-10-M4.5x8			
new	●	●	20	19.5	18.3	40	250	13	≥25	4015-M3.5x9					
	●	●	25	25	23	50	250	17	≥32						
	●	●	32	32	30	60	300	22	≥40						
	●	●	25	25	23	50	250	17	≥32	CC.. 1204..				80-T20	
	●	●	32	32	30	60	300	22	≥40	4020-M4.5x12	-	-			
	●	●	40	40	37.5	70	350	27	≥50	1020-M4.5x16					
	●	●	08	8	7.3	20	100	06	≥11	CC.. 0602..				82-T08	
	●	●	10	10	09	25	100	07	≥13	4008-M2.5x4.5	AACN-2-0001	AAV-08-M3.5x8			
	●	●	12	12	11	25	100	09	≥16	4008-M2.5x6	AACN-2-0003	AAV-10-M4.5x8			
	●	●	16	16	14.8	35	150	11	≥20						
	●	●	20	20	18.3	40	170	13	≥25	CC.. 09T3..				80-T15	
	●	●	25	25	23	50	200	17	≥32	4015-M3.5x9					
	●	●	32	32	30	60	250	22	≥40	4015-M3.5x12					
	●	●	25	25	23	50	200	17	≥32	CC.. 1204..				80-T20	

R: Sağ / Right / Rechts L: Sol / Left / Links

● Stokta / In Stock / Auf Lager ○ Stokta Yok / Non Stock Item / Kein Lagerartikel, Lieferzeit auf Anfrage

Sipariş Örneği/Ordering Example/Bestellbeispiel

1 ad./pcs./stück S0508H SCLCR 03



KAPR=90°

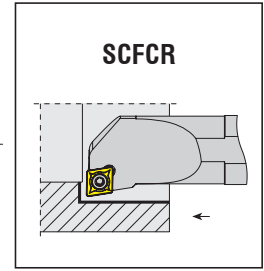
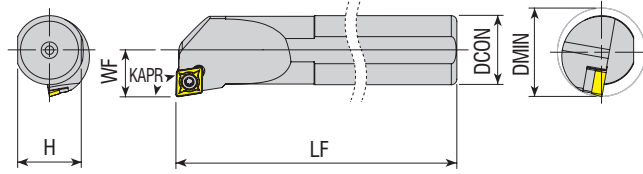

Takım Kodu Ordering Code Bestell-Bezeichnung	Stok Stock Lager		Takım Ölçüleri (mm) Dimension (mm) Abmessung (mm)				Kesici Uç Insert Wendeschneidplatte	Yedek Parçaları / Spare Parts / Ersatzteile				
	R	L	DCON	H	LF	WF		DMIN	Sıkma Vidası Screw Klemmschraube	Altlık Shim Unterlage	Altlık Vidası Shim Screw Schraube für Unterlage	Tork Anahtar Torx Key Torx Innensechskantschlüssel
S08H SCFCR/L 06	●	●	08	7.3	100	06	≥11	CC.. 0602..	4008-M2.5x6	-	-	82-T08
S10K SCFCR/L 06	●	●	10	09	125	07	≥13		4015-M3.5x8			
S12K SCFCR/L 06	●	●	12	11	125	09	≥16					
S12K SCFCR/L 09	●	●	12	11	125	09	≥16	CC.. 09T3..	4015-M3.5x9	-	-	80-T15
S16P SCFCR/L 09	●	●	16	14.8	170	11	≥20		4015-M3.5x12	AACN-2-0001	AAV-08-M3.5x8	
S20R SCFCR/L 09	●	●	20	18.3	200	13	≥25					
S25S SCFCR/L 09	●	●	25	23	250	17	≥32	CC.. 1204..	4020-M4.5x12	AACN-2-0003	AAV-10-M4.5x8	80-T20
S25S SCFCR/L 12	●	○	25	23	250	17	≥32		1020-M4.5x16			
S32T SCFCR/L 12	○	○	32	30	300	22	≥40					
S40U SCFCR/L 12	○	○	40	37.5	350	27	≥50	CC.. 0602..	4008-M2.5x6	-	-	82-T08
A08H SCFCR/L 06	●	○	08	7.3	100	06	≥11					



KAPR=62.5°

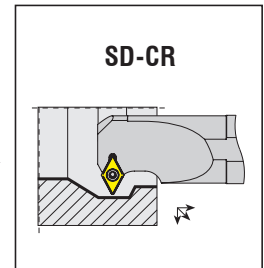
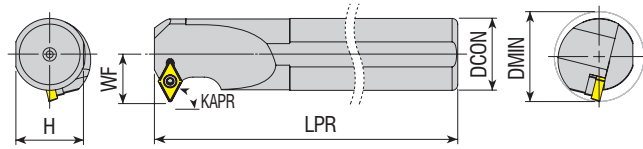

Takım Kodu Ordering Code Bestell-Bezeichnung	Stok Stock Lager		Takım Ölçüleri (mm) Dimension (mm) Abmessung (mm)				Kesici Uç Insert Wendeschneidplatte	Yedek Parçaları / Spare Parts / Ersatzteile				
	R	L	DCON	H	LPR	WF		DMIN	Sıkma Vidası Screw Klemmschraube	Altlık Shim Unterlage	Altlık Vidası Shim Screw Schraube für Unterlage	Tork Anahtar Torx Key Torx Innensechskantschlüssel
S10K SD-CR/L 07	●	●	10	9	125	08	≥14	DC.. 0702..	4008-M2.5x6	-	-	82-T08
S12K SD-CR/L 07	●	●	12	11	125	09	≥16		4015-M3.5x11	-	-	
S16P SD-CR/L 07	●	●	16	14.8	170	11	≥20					
S20R SD-CR/L 07	●	○	20	18.3	200	13	≥25	DC.. 11T3..	4015-M3.5x14	AADN-2-0001	AAV-06-M3.5x11	80-T15
S16P SD-CR/L 11	●	●	16	14.8	170	14	≥22					
S20R SD-CR/L 11	●	●	20	18.3	200	15	≥25					
S25S SD-CR/L 11	●	●	25	23	250	18	≥32					
S32T SD-CR/L 11	●	●	32	30	300	22	≥40					
S40U SD-CR/L 11	●	●	40	37.5	350	27	≥50					

R: Sağ / Right / Rechts L: Sol / Left / Links  
● Stokta / In Stock / Auf Lager ○ Stokta Yok / Non Stock Item / Kein Lagerartikel, Lieferzeit auf Anfrage

Sipariş Örneği/Ordering Example/Bestellbeispiel  
1 ad./pcs./stück S08H SCFCR 06

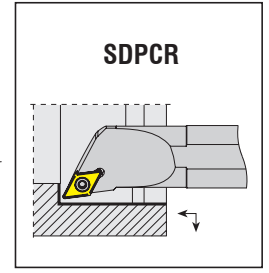
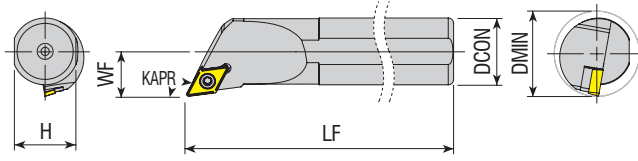

Takım Kodu Ordering Code Bestell-Bezeichnung	Stok Stock Lager		Takım Ölçüleri (mm) Dimension (mm) Abmessung (mm)				Kesici Uç Insert Wendeschneidplatte	Yedek Parçaları / Spare Parts / Ersatzteile				
	R	L	DCON	H	LF	WF		DMIN	Sıkma Vidası Screw Klemmschraube	Altlık Shim Unterlage	Altlık Vidası Shim Screw Schraube für Unterlage	Tork Anahtar Torx Key Torx Innensechskantschlüssel
S10K SDPCR/L 07	●	●	10	09	125	07	≥13	DC.. 0702..	4008-M2.5x6	-	-	82-T08
S12K SDPCR/L 07	●	●	12	11	125	09	≥16					
S16P SDPCR/L 11	●	●	16	14.8	170	11	≥20	DC.. 11T3..	4015-M3.5x9	-	-	80-T15
S20R SDPCR/L 11	●	●	20	18.3	200	13	≥25		4015-M3.5x9	-	-	
S25S SDPCR/L 11	●	●	25	23	250	17	≥32		4015-M3.5x12	AADN-2-0001	AAV-08-M3.5x8	

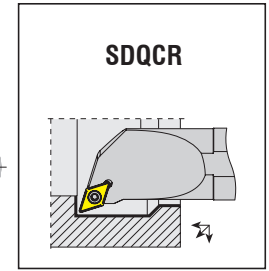
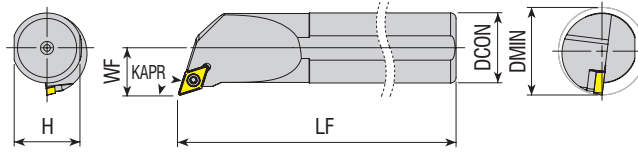

Takım Kodu Ordering Code Bestell-Bezeichnung	Stok Stock Lager		Takım Ölçüleri (mm) Dimension (mm) Abmessung (mm)				Kesici Uç Insert Wendeschneidplatte	Yedek Parçaları / Spare Parts / Ersatzteile				
	R	L	DCON	H	LF	WF		DMIN	Sıkma Vidası Screw Klemmschraube	Altlık Shim Unterlage	Altlık Vidası Shim Screw Schraube für Unterlage	Tork Anahtar Torx Key Torx Innensechskantschlüssel
S10K SDQCR/L 07	●	●	10	09	125	07	≥13	DC.. 0702..	4008-M2.5x6	-	-	82-T08
S12K SDQCR/L 07	●	●	12	11	125	09	≥16					
S16P SDQCR/L 07	●	●	16	14.8	170	11	≥20	DC.. 11T3..	4015-M3.5x9	-	-	80-T15
S20R SDQCR/L 07	●	●	20	18.3	200	13	≥25		4015-M3.5x11	-	-	
S16P SDQCR/L 11	●	●	16	14.8	170	11	≥20		4015-M3.5x12	AADN-2-0001	AAV-08-M3.5x8	
S20R SDQCR/L 11	●	●	20	18.3	200	13	≥25	4015-M3.5x14	AADN-2-0001	AAV-06-M3.5x11		
S25S SDQCR/L 11	●	●	25	23	250	17	≥32	DC.. 11T3..	4015-M3.5x9	-	-	80-T15
S32T SDQCR/L 11	●	●	32	30	300	22	≥40		4015-M3.5x11	-	-	
S40U SDQCR/L 11	●	●	40	37.5	350	27	≥50	4015-M3.5x12	AADN-2-0001	AAV-08-M3.5x8		
A10H SDQCR/L 07	●	●	10	09	100	07	≥13	DC.. 0702..	4008-M2.5x6	-	-	82-T08
A12H SDQCR/L 07	●	●	12	11	100	09	≥16					
A16M SDQCR/L 07	●	●	16	14.8	150	11	≥20	DC.. 11T3..	4015-M3.5x9	-	-	80-T15
A20P SDQCR/L 07	●	●	20	18.3	170	13	≥25		4015-M3.5x11	-	-	
A16M SDQCR/L 11	●	●	16	14.8	150	11	≥20		4015-M3.5x12	AADN-2-0001	AAV-08-M3.5x8	
A20P SDQCR/L 11	●	●	20	18.3	170	13	≥25	4015-M3.5x14	AADN-2-0001	AAV-06-M3.5x11		
A25R SDQCR/L 11	●	●	25	23	200	17	≥32	DC.. 11T3..	4015-M3.5x9	-	-	80-T15
A32S SDQCR/L 11	●	●	32	30	250	22	≥40		4015-M3.5x11	-	-	

R: Sağ / Right / Rechts L: Sol / Left / Links  
● Stokta / In Stock / Auf Lager ○ Stokta Yok / Non Stock Item / Kein Lagerartikel, Lieferzeit auf Anfrage

Sipariş Örneği/Ordering Example/Bestellbeispiel  
1 ad./pcs./stück S10K SDPCR 07



KAPR=93°

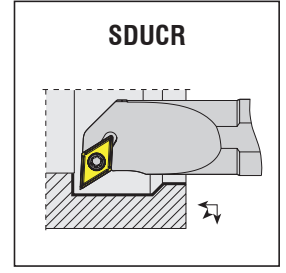
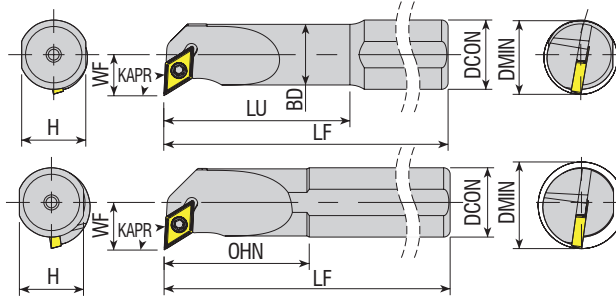

**Takım Kodu**  
**Ordering Code**  
**Bestell-Bezeichnung**

Stok Stock Lager	Takım Ölçüleri (mm) Dimension (mm) Abmessung (mm)									Kesici Uç Insert Wendeschneidplatte	Yedek Parçaları / Spare Parts / Ersatzteile			
	R	L	DCON	BD	H	LU=OHN	LF	WF	DMIN		Sıkma Vidası Screw Klemmschraube	Altılık Shim Unterlage	Altılık Vidası Shim Screw Schraube für Unterlage	Tork Anahtar Torx Key Torx Innensechskantschlüssel
	●	●	10	8	09	30	125	08	≥13	DC.. 0702..	4008-M2.5x6	-	-	82-T08
<b>new</b>	●	●	10	9.5	9	30	150	8	≥13					
	●	●	10	10	09	25	125	08	≥13					
	●	●	12	12	11	25	125	09	≥16					
	●	●	16	11.5	14.8	37	170	09	≥16					
	●	●	16	14	14.8	45	170	9.5	≥17					
	●	●	16	16	14.8	35	170	11	≥20					
	●	●	20	20	18.3	40	200	13	≥25					
	●	●	16	14	14.8	45	170	11	≥18	DC.. 11T3..	4015-M3.5x9	-	-	80-T15
	●	●	16	16	14.8	35	170	11	≥20					
	●	●	20	16	18.3	50	200	11	≥20					
	●	●	20	20	18.3	40	200	13	≥25					
	●	●	25	25	23	50	250	17	≥32					
	●	●	25	25	23	50	300	17	≥32					
	●	●	32	32	30	60	300	22	≥40					
	●	●	40	40	37.5	70	350	27	≥50					
	●	●	50	50	47	80	400	35	≥63					
	●	●	10	8	09	30	100	08	≥13	DC.. 0702..	4008-M2.5x6	-	-	82-T08
	●	●	10	10	09	25	100	08	≥13					
	●	●	12	12	11	25	100	09	≥16					
	●	●	16	16	14.8	35	150	11	≥20					
	●	●	20	20	18.3	40	170	13	≥25					
	●	●	16	16	14.8	35	150	11	≥20					
	●	●	20	20	18.3	40	170	13	≥25					
	●	●	25	25	23	50	200	17	≥32					
	●	●	25	25	23	50	300	17	≥32					
	●	○	25	25	23	50	300	17	≥32					
	●	●	32	32	30	60	250	22	≥40					
	●	○	50	50	47	80	350	35	≥63					
	●	●	16	16	14.8	35	150	11	≥20	DC.. 11T3..	4015-M3.5x9	-	AAV-08-M3.5x8	80-T15
	●	●	20	20	18.3	40	170	13	≥25					
	●	●	25	25	23	50	200	17	≥32					
	●	○	25	25	23	50	300	17	≥32					
	●	●	32	32	30	60	250	22	≥40					
	●	○	50	50	47	80	350	35	≥63					
	●	○	50	50	47	80	350	35	≥63					

R: Sağ / Right / Rechts L: Sol / Left / Links

● Stokta / In Stock / Auf Lager ○ Stokta Yok / Non Stock Item / Kein Lagerartikel, Lieferzeit auf Anfrage

Sipariş Örneği/Ordering Example/Bestellbeispiel

1 ad./pcs./stück S0810K SDUCR 07

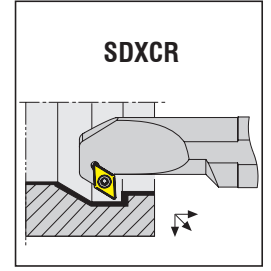
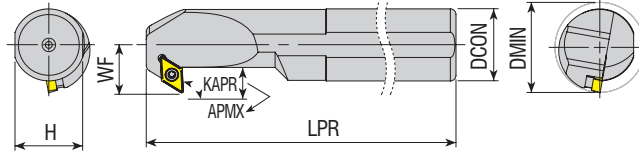

Takım Kodu Ordering Code Bestell-Bezeichnung	Stok Stock Lager		Takım Ölçüleri (mm) Dimension (mm) Abmessung (mm)					Kesici Uç Insert Wendeschneidplatte	Yedek Parçaları / Spare Parts / Ersatzteile				
	R	L	DCON	H	LPR	WF	APMX		DMIN	Sıkma Vidası Screw Klemmschraube	Altlık Shim Unterlage	Altlık Vidası Shim Screw Schraube für Unterlage	Tork Anahtar Torx Key Torn Innenschlankschlüssel
S12K SDXCR/L 07	●	●	12	11	125	09	4.5	≥16	DC.. 0702..	4008-M2.5x6	-	-	82-T08
S16P SDXCR/L 07	●	●	16	14.8	170	11	6.5	≥20					
S20R SDXCR/L 07	●	●	20	18.3	200	13	6.5	≥25					
S16P SDXCR/L 11	●	●	16	14.8	170	11	6.5	≥20	DC.. 11T3..	4015-M3.5x9	-	-	80-T15
S20R SDXCR/L 11	●	●	20	18.3	200	14	7.5	≥25					
S25S SDXCR/L 11	●	●	25	23	250	17	9	≥32					
S32T SDXCR/L 11	●	●	32	30	300	22	12.5	≥40					
S40U SDXCR/L 11	●	●	40	37.5	350	27	14.5	≥50	DC.. 11T3..	4015-M3.5x14	AADN-2-0001	AAV-08-M3.5x8	80-T15
A12H SDXCR/L 07	●	●	12	11	100	09	4.5	≥16				AAV-06-M3.5x11	
A16M SDXCR/L 07	●	●	16	14.8	150	11	6.5	≥20	DC.. 0702..	4008-M2.5x6	-	-	82-T08
A20P SDXCR/L 07	●	●	20	18.3	170	13	6.5	≥25					
A16M SDXCR/L 11	●	●	16	14.8	150	11	7.5	≥20					
A20P SDXCR/L 11	●	●	20	18.3	170	14	7.5	≥25	DC.. 11T3..	4015-M3.5x11	-	-	80-T15
A25R SDXCR/L 11	●	●	25	23	200	17	9	≥32					
A32S SDXCR/L 11	●	●	32	30	250	22	12.5	≥40					
										AADN-2-0001	AAV-06-M3.5x11		

R: Sağ / Right / Rechts L: Sol / Left / Links  
● Stokta / In Stock / Auf Lager ○ Stokta Yok / Non Stock Item / Kein Lagerartikel, Lieferzeit auf Anfrage  
Not: "APMX" ölçüleri R0.4'e göre verilmiştir.  
Note: Dimensions of "APMX" are given according to R.0,4  
Hinweis: Das Maß "APMX" bezieht sich auf R 0,4

Sipariş Örneği/Ordering Example/Bestellbeispiel  
1 ad./pcs./stück S12K SDXCR 07

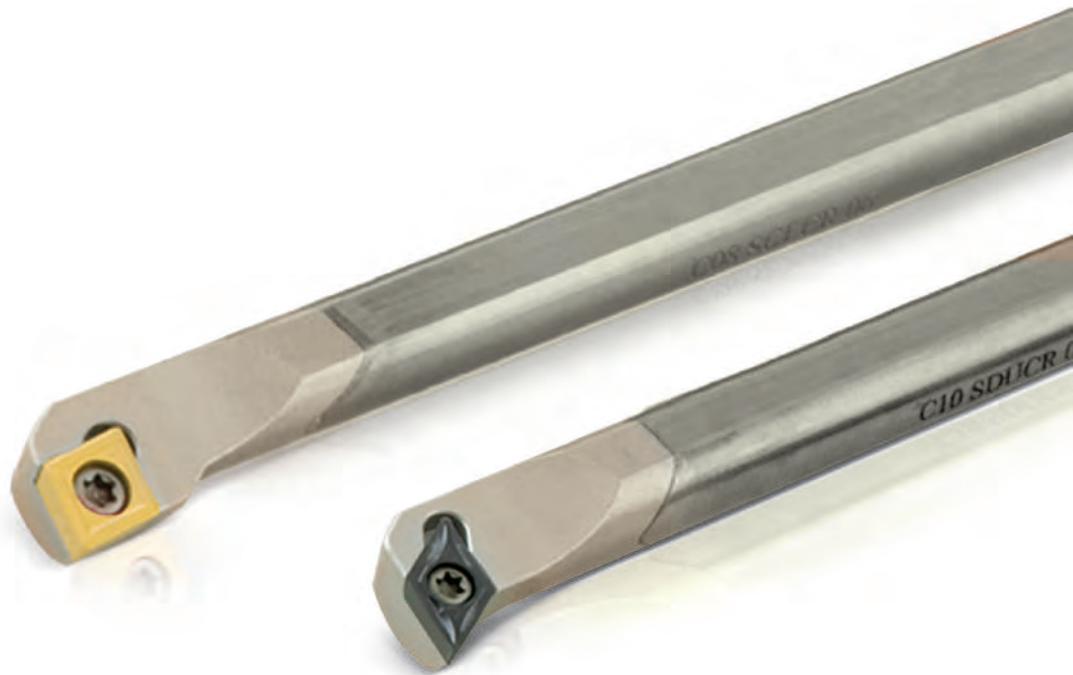

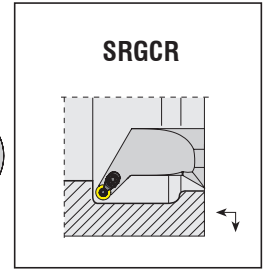
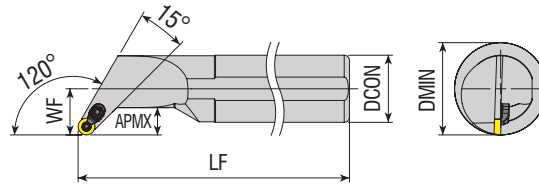
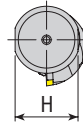

**Takım Kodu**  
**Ordering Code**  
**Bestell-Bezeichnung**

Stok  
Stock  
Lager

Takım Ölçüleri (mm)  
Dimension (mm)  
Abmessung (mm)

Kesici Uç  
Insert  
Wendeschneidplatte

Sıkma Vidası  
Screw  
Klemmschraube

Altlık  
Shim  
Unterlage

Altlık Vidası  
Shim Screw  
Schraube für Unterlage

Baskı Pabucu  
Shim Screw  
Spannpratze

Pabuç Vidası  
Shim Screw  
Klemmschraube

Anahtar  
Allen Key  
Innensechskantschlüssel

Yedek Parçaları / Spare Parts / Ersatzteile

Takım Kodu Ordering Code Bestell-Bezeichnung	Stok Stock Lager		Takım Ölçüleri (mm) Dimension (mm) Abmessung (mm)					Kesici Uç Insert Wendeschneidplatte	Sıkma Vidası Screw Klemmschraube	Altlık Shim Unterlage	Altlık Vidası Shim Screw Schraube für Unterlage	Baskı Pabucu Shim Screw Spannpratze	Pabuç Vidası Shim Screw Klemmschraube	Anahtar Allen Key Innensechskantschlüssel	
	R	L	DCON	H	LF	WF	APMX								DMIN
S16P SRGCR/L 08	●	○	16	14.8	170	11	7	≥22	RC.. 0803..	3008-M3x8	-	-	-	-	82-T08
S20R SRGCR/L 08	●	●	20	18.3	200	13	7	≥26							
S25S SRGCR/L 08C	●	●	25	23	250	17	9.5	≥34							
S32T SRGCR/L 08C	●	○	32	30	300	22	13	≥44							
S40U SRGCR/L 08C	●	○	40	37.5	350	27	15	≥54							
A16M SRGCR/L 08	●	●	16	14.8	150	11	7	≥22							
A20P SRGCR/L 08	●	●	20	18.3	170	13	7	≥26							
A25R SRGCR/L 08C	●	●	25	23	200	17	9.5	≥34							
A32S SRGCR/L 08C	●	●	32	30	250	22	13	≥44							
A40T SRGCR/L 08C	●	●	40	37.5	300	27	15	≥54							



KAPR=45°

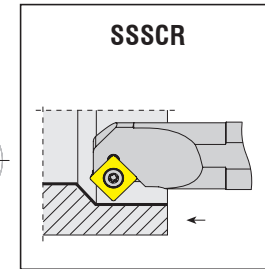
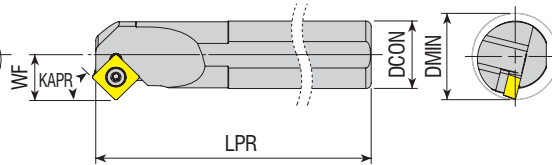
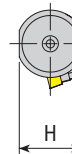

**Takım Kodu**  
**Ordering Code**  
**Bestell-Bezeichnung**

Stok  
Stock  
Lager

Takım Ölçüleri (mm)  
Dimension (mm)  
Abmessung (mm)

Kesici Uç  
Insert  
Wendeschneidplatte

Sıkma Vidası  
Screw  
Klemmschraube

Altlık  
Shim  
Unterlage

Altlık Vidası  
Shim Screw  
Schraube für Unterlage

Tork Anahtar  
Torx Key  
Innensechskantschlüssel

Yedek Parçaları / Spare Parts / Ersatzteile

Takım Kodu Ordering Code Bestell-Bezeichnung	Stok Stock Lager		Takım Ölçüleri (mm) Dimension (mm) Abmessung (mm)					Kesici Uç Insert Wendeschneidplatte	Sıkma Vidası Screw Klemmschraube	Altlık Shim Unterlage	Altlık Vidası Shim Screw Schraube für Unterlage	Tork Anahtar Torx Key Innensechskantschlüssel
	R	L	DCON	H	LPR	WF	DMIN					
S16P SSSCR/L 09	●	●	16	14.8	170	11	≥20	SC.. 09T3..	4015-M3.5x9	-	-	80-T15
S20R SSSCR/L 09	●	●	20	18.3	200	13	≥25					
S25S SSSCR/L 09	●	●	25	23	250	17	≥32					
S25S SSSCR/L 12	●	●	25	23	250	17	≥32	SC.. 1204..	4020-M4.5x12 1020-M4.5x16	AASN-2-0001 AASN-2-0004	AAV-08-M3.5x8 AAV-10-M4.5x8 AAV-07-M4.5x8	80-T20
S32T SSSCR/L 12	●	○	32	30	300	22	≥40					
S40U SSSCR/L 12	●	○	40	37.5	350	27	≥50					

R: Sağ / Right / Rechts L: Sol / Left / Links

● Stokta / In Stock / Auf Lager ○ Stokta Yok / Non Stock Item / Kein Lagerartikel, Lieferzeit auf Anfrage

Sipariş Örneği/Ordering Example/Bestellbeispiel

1 ad./pcs./stück S16P SRGCR 08

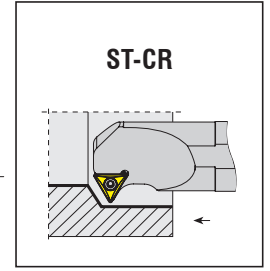
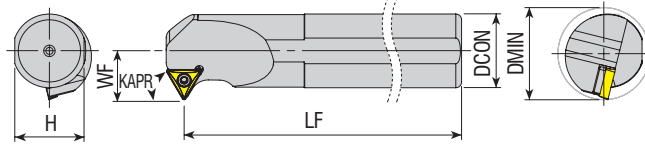

Takım Kodu Ordering Code Bestell-Bezeichnung	Stok Stock Lager		Takım Ölçüleri (mm) Dimension (mm) Abmessung (mm)					Kesici Uç Insert Wendeschneidplatte	Yedek Parçaları / Spare Parts / Ersatzteile			
	R	L	DCON	H	LF	WF	DMIN		Sıkma Vidası Screw Klemmschraube	Altılık Shim Unterlage	Altılık Vidası Shim Screw Schraube für Unterlage	Tork Anahtar Torx Key Torx Innensechskantschlüssel
S12K ST-CR/L 11	●	●	12	11	125	09	≥17	TC.. 1102..	4008-M2.5x6	-	-	82-T08
S16P ST-CR/L 11	●	○	16	14.8	170	11	≥20		4015-M3.5x9	-	-	
S20R ST-CR/L 11	●	○	20	18.3	200	13	≥25	TC.. 16T3..	4015-M3.5x11	-	-	80-T15
S16P ST-CR/L 16	●	●	16	14.8	170	11	≥20		4015-M3.5x14	AATN-2-0001	AAV-08-M3.5x8	
S20R ST-CR/L 16	●	●	20	18.3	200	13	≥25			AAV-06-M3.5x11		
S25S ST-CR/L 16	●	●	25	23	250	17	≥32					
S32T ST-CR/L 16	●	●	32	30	300	22	≥40					
S40U ST-CR/L 16	●	●	40	37.5	350	27	≥50					

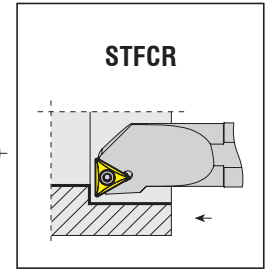
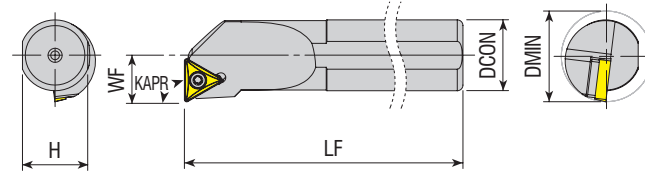

Takım Kodu Ordering Code Bestell-Bezeichnung	Stok Stock Lager		Takım Ölçüleri (mm) Dimension (mm) Abmessung (mm)					Kesici Uç Insert Wendeschneidplatte	Yedek Parçaları / Spare Parts / Ersatzteile			
	R	L	DCON	H	LF	WF	DMIN		Sıkma Vidası Screw Klemmschraube	Altılık Shim Unterlage	Altılık Vidası Shim Screw Schraube für Unterlage	Tork Anahtar Torx Key Torx Innensechskantschlüssel
S0610F STF-CR/L 06	●	●	10	09	80	4.5	≥08	TC.. 06T1..	3006-M2x4	-	-	82-T06
S08H STF-CR/L 06	●	●	08	7.3	100	06	≥11					
S10K STF-CR/L 09	●	●	10	09	125	07	≥13	TC.. 0902..	3007-M2.2x4.6	-	-	82-T07
S12K STF-CR/L 09	●	●	12	11	125	09	≥17					
S12K STF-CR/L 11	●	●	12	11	125	09	≥17	TC.. 1102..	4008-M2.5x6	-	-	82-T08
S16P STF-CR/L 11	●	●	16	14.8	170	11	≥20		4015-M3.5x9	-	-	
S20R STF-CR/L 11	●	●	20	18.3	200	13	≥25	4015-M3.5x11	-	-		
S16P STF-CR/L 16	●	●	16	14.8	170	11	≥20	TC.. 16T3..	4015-M3.5x14	AATN-2-0001	AAV-08-M3.5x8	80-T15
S20R STF-CR/L 16	●	●	20	18.3	200	13	≥25				AAV-06-M3.5x11	
S25S STF-CR/L 16	●	●	25	23	250	17	≥32					
S32T STF-CR/L 16	●	●	32	30	300	22	≥40					
S40U STF-CR/L 16	●	○	40	37.5	350	27	≥50					
A10H STF-CR/L 11	●	●	10	09	100	07	≥13	TC.. 1102..	4008-M2.5x6	-	-	82-T08
A12H STF-CR/L 11	●	●	12	11	100	09	≥17					
A16M STF-CR/L 11	●	●	16	14.8	150	11	≥20	TC.. 16T3..	4015-M3.5x11	-	-	80-T15
A20R STF-CR/L 16	●	○	20	18.3	200	13	≥25					

R: Sağ / Right / Rechts L: Sol / Left / Links

● Stokta / In Stock / Auf Lager ○ Stokta Yok / Non Stock Item / Kein Lagerartikel, Lieferzeit auf Anfrage

Sipariş Örneği/Ordering Example/Bestellbeispiel

1 ad./pcs./stück S12K ST-CR 11



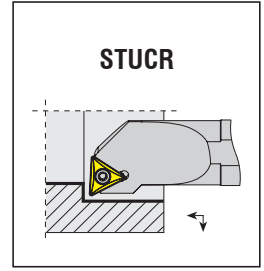
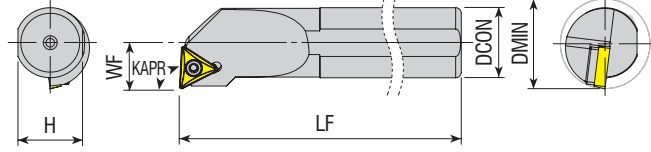

Takım Kodu Ordering Code Bestell-Bezeichnung	Stok Stock Lager		Takım Ölçüleri (mm) Dimension (mm) Abmessung (mm)				Kesici Uç Insert Wendeschneidplatte	Yedek Parçaları / Spare Parts / Ersatzteile				
	R	L	DCON	H	LF	WF		DMIN	Sıkma Vidası Screw Klemmschraube	Altlık Shim Unterlage	Altlık Vidası Shim Screw Schraube für Unterlage	Tork Anahtar Torx Key Torx Innensechskantschlüssel
S10K STUCR/L 09	●	●	10	09	125	07	≥13	TC.. 0902..	3007-M2.2x4.6			82-T07
S12K STUCR/L 09	●	●	12	11	125	09	≥16					
S12K STUCR/L 11	●	●	12	11	125	09	≥17	TC.. 1102..	4008-M2.5x6	-	-	82-T08
S16P STUCR/L 11	●	●	16	14.8	170	11	≥20					
S20R STUCR/L 11	●	●	20	18.3	200	13	≥25	TC.. 16T3..	4015-M3.5x9 4015-M3.5x11	-	-	80-T15
S16P STUCR/L 16	●	●	16	14.8	170	11	≥20					
S20R STUCR/L 16	●	●	20	18.3	200	13	≥25	TC.. 16T3..	4015-M3.5x14	AATN-2-0001	AAV-08-M3.5x8 AAV-06-M3.5x11	80-T15
S25S STUCR/L 16	●	●	25	23	250	17	≥32					
S32T STUCR/L 16	●	●	32	30	300	22	≥40	TC.. 0902..	3007-M2.2x4.6			82-T07
S40U STUCR/L 16	●	●	40	37.5	350	27	≥50					
A10H STUCR/L 09	●	●	10	09	100	07	≥13	TC.. 1102..	4008-M2.5x6	-	-	82-T08
A12H STUCR/L 09	●	●	12	11	100	09	≥16					
A12H STUCR/L 11	●	●	12	11	100	09	≥16	TC.. 16T3..	4015-M3.5x9 4015-M3.5x11	-	-	80-T15
A16M STUCR/L 11	●	●	16	14.8	150	11	≥20					
A20P STUCR/L 11	●	●	20	18.3	170	13	≥25	TC.. 16T3..	4015-M3.5x12 4015-M3.5x14	AATN-2-0001	AAV-08-M3.5x8 AAV-06-M3.5x11	80-T15
A16M STUCR/L 16	●	●	16	14.8	150	11	≥20					
A20P STUCR/L 16	●	●	20	18.3	170	13	≥25					
A25R STUCR/L 16	●	●	25	23	200	17	≥32					
A32S STUCR/L 16	●	●	32	30	250	22	≥40					

R: Sağ / Right / Rechts L: Sol / Left / Links  
● Stokta / In Stock / Auf Lager ○ Stokta Yok / Non Stock Item / Kein Lagerartikel, Lieferzeit auf Anfrage

Sipariş Örneği/Ordering Example/Bestellbeispiel  
1 ad./pcs./stück S10K STUCR 09



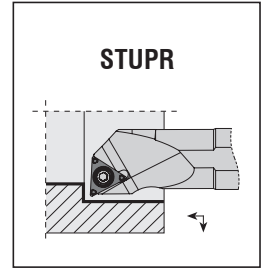
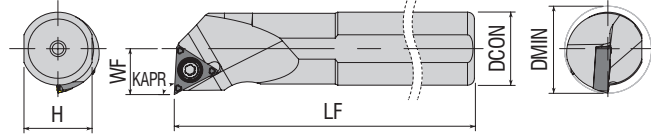

Takım Kodu Ordering Code Bestell-Bezeichnung	Stok Stock Lager	Takım Ölçüleri (mm) Dimension (mm) Abmessung (mm)						Kesici Uç Insert Wendeschneidplatte	Yedek Parçaları / Spare Parts / Ersatzteile				
		R	L	DCON	H	LF	WF		DMIN	Sıkma Vidası Screw Klemmschraube	Altlık Shim Unterlage	Altlık Vidası Shim Screw Schraube für Unterlage	Tork Anahtar Torx Key Torx Innensechskantschlüssel
S08H STUPR/L 0802	● ○	08	7.3	100	05	≥10	TP. 0802..	3006-M2x4				82-T06	
S10K STUPR/L 1103	● ○	10	09	125	06	≥12							
S12K STUPR/L 1103	● ●	12	11	125	09	≥16	TP. 1103..	4010-M3x6	-	-	82-T10		
S12M STUPR/L 1103	● ●	12	11	150	09	≥16							
S16P STUPR/L 1103	● ●	16	14.8	170	10	≥20							
S16R STUPR/L 1103	● ●	16	14.8	200	10	≥20							
A20R STUPR/L 1103	● ○	20	18.3	200	13	≥25							

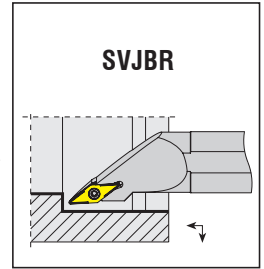
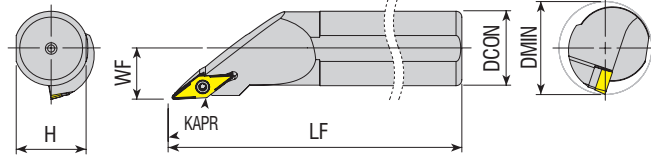

Takım Kodu Ordering Code Bestell-Bezeichnung	Stok Stock Lager	Takım Ölçüleri (mm) Dimension (mm) Abmessung (mm)						Kesici Uç Insert Wendeschneidplatte	Yedek Parçaları / Spare Parts / Ersatzteile				
		R	L	DCON	H	LF	WF		DMIN	Sıkma Vidası Screw Klemmschraube	Altlık Shim Unterlage	Altlık Vidası Shim Screw Schraube für Unterlage	Tork Anahtar Torx Key Torx Innensechskantschlüssel
S25S SVJBR/L 16	● ●	25	23	250	17	≥32	VB.. 1604..	4015-M3.5x12	AAVN-2-0002	AAV-08-M3.5x8	80-T15		
S32T SVJBR/L 16	● ●	32	30	300	22	≥40							
S40U SVJBR/L 16	● ●	40	37.5	350	27	≥50						4015-M3.5x14	AAV-06-M3.5x11

R: Sağ / Right / Rechts L: Sol / Left / Links  
● Stokta / In Stock / Auf Lager ○ Stokta Yok / Non Stock Item / Kein Lagerartikel, Lieferzeit auf Anfrage

Sipariş Örneği/Ordering Example/Bestellbeispiel  
1 ad./pcs./stück S08H STUPR 0802

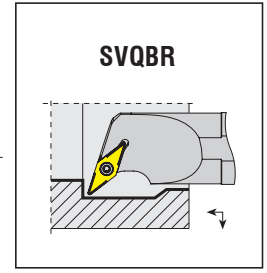
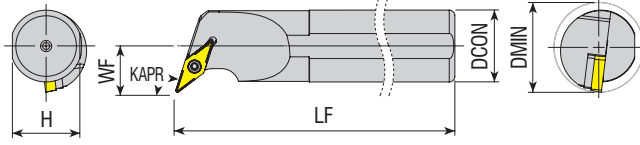

Takım Kodu Ordering Code Bestell-Bezeichnung	Stok Stock Lager		Takım Ölçüleri (mm) Dimension (mm) Abmessung (mm)				Kesici Uç Insert Wendeschneidplatte	Sıkma Vidası Screw Klemmschraube	Altlık Shim Unterlage	Altlık Vidası Shim Screw Schraube für Unterlage	Tork Anahtar Torx Key Torx Innensechskantschlüssel	
	R	L	DCON	H	LF	WF						DMIN
S16P SVQBR/L 11	●	●	16	14.8	170	11	≥20	VB.. 1103..	4008-M2.5x6	-	-	82-T08
S20R SVQBR/L 11	●	●	20	18.3	200	13	≥25					
S25S SVQBR/L 16	●	●	25	23	250	17	≥32	VB.. 1604..	4015-M3.5x14	AAVN-2-0002	AAV-08-M3.5x8	80-T15
S32T SVQBR/L 16	●	●	32	30	300	22	≥40				AAV-06-M3.5x11	
S40U SVQBR/L 16	●	●	40	37.5	350	27	≥50	VB.. 1103..	4008-M2.5x6	-	-	82-T08
A20Q SVQBR/L 11	●	●	20	18.3	180	13	≥25					
A20Q SVQBR/L 16	●	●	20	18.5	180	20	≥30	VB.. 1604..	4015-M3.5x11	-	-	80-T15
A25S SVQBR/L 16	●	●	25	23	250	17	≥32					
A32S SVQBR/L 16	●	●	32	30	250	22	≥40	4015-M3.5x14	AAVN-2-0002	AAV-08-M3.5x8		

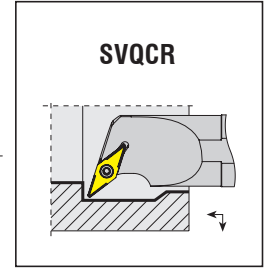
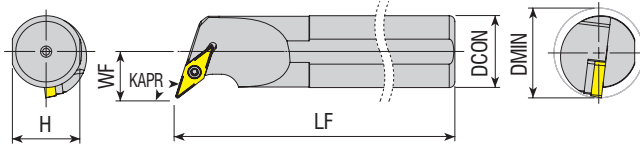

Takım Kodu Ordering Code Bestell-Bezeichnung	Stok Stock Lager		Takım Ölçüleri (mm) Dimension (mm) Abmessung (mm)				Kesici Uç Insert Wendeschneidplatte	Sıkma Vidası Screw Klemmschraube	Altlık Shim Unterlage	Altlık Vidası Shim Screw Schraube für Unterlage	Tork Anahtar Torx Key Torx Innensechskantschlüssel	
	R	L	DCON	H	LF	WF						DMIN
S16P SVQCR/L 11	●	●	16	14.8	170	11	≥20	VC.. 1103..	4008-M2.5x6	-	-	82-T08
S20R SVQCR/L 11	●	●	20	18.3	200	13	≥25					
S25S SVQCR/L 16	●	●	25	23	250	17	≥32	VC.. 1604..	4015-M3.5x14	AAVN-2-0002	AAV-08-M3.5x8	80-T15
S32T SVQCR/L 16	●	●	32	30	300	22	≥40				AAV-06-M3.5x11	
S40U SVQCR/L 16	●	●	40	37.5	350	27	≥50	VC.. 1103..	4008-M2.5x6	-	-	82-T08
A16M SVQCR/L 11	●	●	16	14.8	150	11	≥20					
A20P SVQCR/L 11	●	●	20	18.3	170	13	≥25	VC.. 1604..	4015-M3.5x14	AAVN-2-0002	AAV-08-M3.5x8	80-T15
A25R SVQCR/L 16	●	●	25	23	200	17	≥32				AAV-06-M3.5x11	
A32S SVQCR/L 16	●	●	32	30	250	22	≥40					
A40T SVQCR/L 16	●	●	40	37.5	300	27	≥50					

R: Sağ / Right / Rechts L: Sol / Left / Links  
● Stokta / In Stock / Auf Lager ○ Stokta Yok / Non Stock Item / Kein Lagerartikel, Lieferzeit auf Anfrage

Sipariş Örneği/Ordering Example/Bestellbeispiel  
1 ad./pcs./stück S16P SVQBR 11

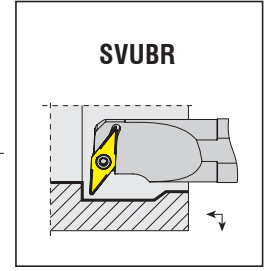
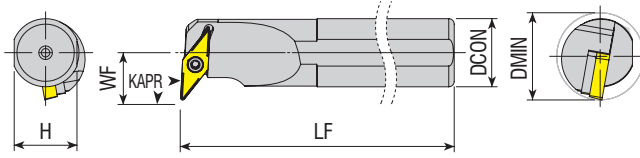

Takım Kodu Ordering Code Bestell-Bezeichnung	Stok Stock Lager		Takım Ölçüleri (mm) Dimension (mm) Abmessung (mm)				Kesici Uç Insert Wendeschneidplatte	Yedek Parçaları / Spare Parts / Ersatzteile				
	R	L	DCON	H	LF	WF		DMIN	Sıkma Vidası Screw Klemmschraube	Altık Shim Unterlage	Altık Vidası Shim Screw Schraube für Unterlage	Tork Anahtar Torx Key Torx Innensechskantschlüssel
S16P SVUBR/L 11	●	●	16	14.8	170	12.5	≥20	VB.. 1103..	4008-M2.5x6	-	-	82-T08
S20R SVUBR/L 11	●	●	20	18.3	200	13	≥25					
S25S SVUBR/L 16	●	●	25	23	250	19	≥32	VB.. 1604..	4015-M3.5x14	AAVN-2-0002	AAV-06-M3.5x11	80-T15
S32T SVUBR/L 16	●	●	32	30	300	22	≥40					
S40U SVUBR/L 16	●	●	40	37.5	350	27	≥50					
A20Q SVUBR/L 16	●	○	20	18.3	180	20	≥30	4015-M3.5x11	-	-	-	-
A32S SVUBR/L 16	●	●	32	30	250	22	≥40	4015-M3.5x14	AAVN-2-0002	AAV-06-M3.5x11	-	-

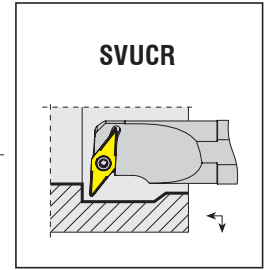
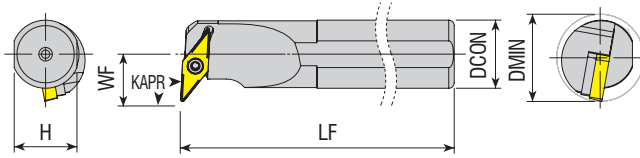

Takım Kodu Ordering Code Bestell-Bezeichnung	Stok Stock Lager		Takım Ölçüleri (mm) Dimension (mm) Abmessung (mm)				Kesici Uç Insert Wendeschneidplatte	Yedek Parçaları / Spare Parts / Ersatzteile				
	R	L	DCON	H	LF	WF		DMIN	Sıkma Vidası Screw Klemmschraube	Altık Shim Unterlage	Altık Vidası Shim Screw Schraube für Unterlage	Tork Anahtar Torx Key Torx Innensechskantschlüssel
S16P SVUCR/L 11	●	●	16	14.8	170	12.5	≥20	VC.. 1103..	4008-M2.5x6	-	-	82-T08
S20R SVUCR/L 11	●	●	20	18.3	200	13	≥25					
S25S SVUCR/L 16	●	●	25	23	250	19	≥32	VC.. 1604..	4015-M3.5x14	AAVN-2-0002	AAV-06-M3.5x11	80-T15
S32T SVUCR/L 16	●	●	32	30	300	22	≥40					
S40U SVUCR/L 16	●	●	40	37.5	350	27	≥50					
A12K SVUCR/L 07	●	●	12	11	125	9	≥16	VC.. 0702..	3006-M2x4	-	-	82-T06
A20P SVUCR/L 11	●	○	20	18.3	170	13	≥25	VC.. 1103..	4008-M2.5x6	-	-	82-T08
A20Q SVUCR/L 11	●	●	20	18.3	180	13	≥25	VC.. 1103..	4008-M2.5x6	-	-	82-T08
A25R SVUCR/L 16	●	●	25	23	200	19	≥32	VC.. 1604..	4015-M3.5x14	AAVN-2-0002	AAV-06-M3.5x11	80-T15

R: Sağ / Right / Rechts L: Sol / Left / Links

● Stokta / In Stock / Auf Lager ○ Stokta Yok / Non Stock Item / Kein Lagerartikel, Lieferzeit auf Anfrage

Sipariş Örneği/Ordering Example/Bestellbeispiel

1 ad./pcs./stück S16P SVUBR 11

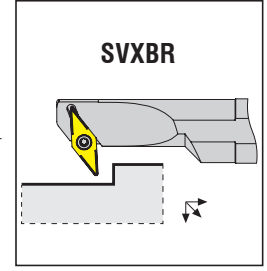
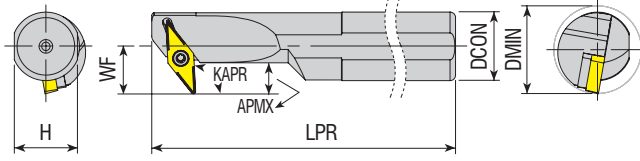

Takım Kodu Ordering Code Bestell-Bezeichnung	Stok Stock Lager		Takım Ölçüleri (mm) Dimension (mm) Abmessung (mm)					Kesici Uç Insert Wendeschneidplatte	Yedek Parçaları / Spare Parts / Ersatzteile				
	R	L	DCON	H	LPR	WF	APMX		DMIN	Sıkma Vidası Screw Klemmschraube	Altık Shim Unterlage	Altık Vidası Shim Screw Schraube für Unterlage	Tork Anahtar Torx Key Torx Innensechskantschlüssel
<b>S16P SVXBR/L 1102</b>	●	○	16	14.8	170	12.5	7.2	≥20	VB.. 1102..	4008-M2.5x6	-	-	82-T08
<b>S20R SVXBR/L 1102</b>	●	●	20	18.3	200	13	5.7	≥25					
<b>S16P SVXBR/L 11</b>	●	●	16	14.8	170	12.5	7.2	≥21	VB.. 1103..				
<b>S20R SVXBR/L 11</b>	●	●	20	18.3	200	13	5.7	≥25					
<b>S25S SVXBR/L 16</b>	●	●	25	23	250	19	10.2	≥32	VB.. 1604..	4015-M3.5x14	AAVN-2-0002	AAV-06-M3.5x11	80-T15
<b>S32T SVXBR/L 16</b>	●	●	32	30	300	22	11.7	≥40					
<b>S40U SVXBR/L 16</b>	●	●	40	37.5	350	27	14.3	≥50					

Not: "APMX" ölçüleri R0.4'e göre verilmiştir.  
Note: Dimensions of "APMX" are given according to R0.4  
Hinweis: Das Maß "APMX" bezieht sich auf R 0,4

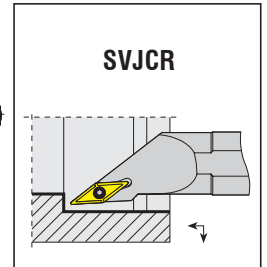
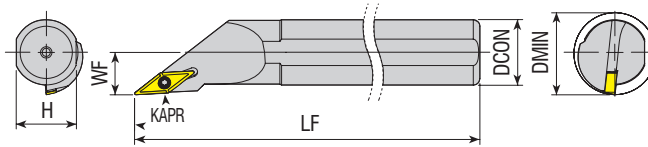

Takım Kodu Ordering Code Bestell-Bezeichnung	Stok Stock Lager		Takım Ölçüleri (mm) Dimension (mm) Abmessung (mm)					Kesici Uç Insert Wendeschneidplatte	Yedek Parçaları / Spare Parts / Ersatzteile			
	R	L	DCON	H	LF	WF	DMIN		Sıkma Vidası Screw Klemmschraube	Altık Shim Unterlage	Altık Vidası Shim Screw Schraube für Unterlage	Tork Anahtar Torx Key Torx Innensechskantschlüssel
<b>S12K SVJCR/L 11</b>	●	●	12	11	125	7	≥13	VC.. 1103..	4008-M2.5x6	-	-	82-T08
<b>S16P SVJCR/L 11</b>	●	●	16	14.8	170	11	≥20					
<b>S20R SVJCR/L 11</b>	●	●	20	18.3	200	13	≥25					
<b>A12H SVJCR/L 11</b>	●	●	12	11	100	07	≥13					
<b>A16M SVJCR/L 11</b>	●	●	16	14.8	150	11	≥20					
<b>A20P SVJCR/L 11</b>	●	●	20	18.3	170	13	≥25					

R: Sağ / Right / Rechts L: Sol / Left / Links  
● Stokta / In Stock / Auf Lager ○ Stokta Yok / Non Stock Item / Kein Lagerartikel, Lieferzeit auf Anfrage

Sipariş Örneği/Ordering Example/Bestellbeispiel  
1 ad./pcs./stück S16P SVXBR 1102

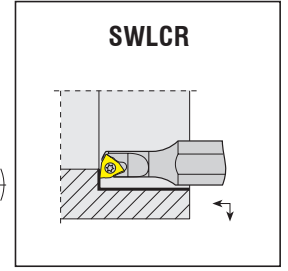
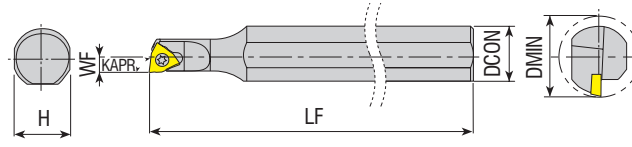

Takım Kodu Ordering Code Bestell-Bezeichnung	Stok Stock Lager		Takım Ölçüleri (mm) Dimension (mm) Abmessung (mm)					Kesici Uç Insert Wendeschneidplatte	Yedek Parçaları / Spare Parts / Ersatzteile			
	R	L	DCON	H	LF	WF	DMIN		Sıkma Vidası Screw Klemmschraube	Altık Shim Unterlage	Altık Vidası Shim Screw Schraube für Unterlage	Tork Anahtar Torx Key Torx Innensechskantschlüssel
	●	○										
S0608H SWLCR/L 03	●	○	08	7.3	100	04	≥08	WC.. 0302..	4008-M2.5x4	-	-	82-T08
S0810K SWLCR/L 03	●	○	10	09	125	06	≥10		4008-M2.5x4.5	-	-	

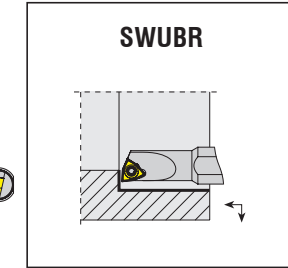
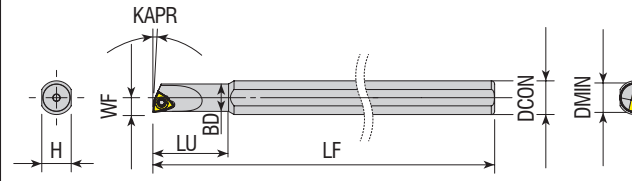

Takım Kodu Ordering Code Bestell-Bezeichnung	Stok Stock Lager		Takım Ölçüleri (mm) Dimension (mm) Abmessung (mm)							Kesici Uç Insert Wendeschneidplatte	Yedek Parçaları / Spare Parts / Ersatzteile			
	R	L	DCON	BD	H	LU	LF	DMIN	WF		Sıkma Vidası Screw Klemmschraube	Altık Shim Unterlage	Altık Vidası Shim Screw Schraube für Unterlage	Tork Anahtar Torx Key Torx Innensechskantschlüssel
	●	○												
S0610H SWUBR/L 06	●	○	10	5	7.3	18	100	≥6	3	WBGT 060102-L	3006-M2x3.3	-	-	82-T06
S08H SWUBR/L 06-5.5	●	●	08	5	7.3	18	100	≥5.7	2.75					
S08H SWUBR/L 06-7	●	○	08	6.5	7.3	18	100	≥7	3.5					

R: Sağ / Right / Rechts L: Sol / Left / Links  
● Stokta / In Stock / Auf Lager ○ Stokta Yok / Non Stock Item / Kein Lagerartikel, Lieferzeit auf Anfrage  
KYCR-ISCR Ucuna Uygundur. / Compatible with KYCR-ISCR Insert. / Kompatibel mit KYCR-ISCR Wendeplatten.

Sipariş Örneği/Ordering Example/Bestellbeispiel  
1 ad./pcs./stück S0608H SWLCR 03

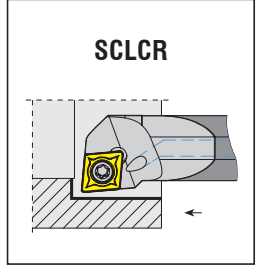
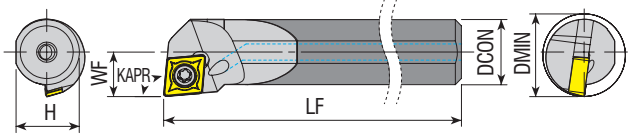

Takım Kodu Ordering Code Bestell-Bezeichnung	Stok Stock Lager		Takım Ölçüleri (mm) Dimension (mm) Abmessung (mm)				Kesici Uç Insert Wendeschneidplatte	Yedek Parçaları / Spare Parts / Ersatzteile				
	R	L	DCON	H	LF	WF		DMIN	Sıkma Vidası Screw Klemmschraube	Altlık Shim Unterlage	Altlık Vidası Shim Screw Schraube für Unterlage	Tork Anahtar Torx Key Torx Innensechskantschlüssel
	●	○										
C04G SCLCR/L 03	●	○	4	3.7	90	2.5	≥5	CC.. 0301..	4006-M1.6x3.2			82-T06
C05H SCLCR/L 03	●	○	5	4.7	100	3	≥6					
C06J SCLCR/L 04	●	○	6	5.7	110	3.5	≥7	CC.. 0401..	3006-M2x3.3			82-T08
C07K SCLCR/L 04	●	○	7	6.7	125	4	≥8					
C06J SCLCR/L 06	●	○	6	5.7	110	4.5	≥8	CC.. 0602..	4008-M2.5x4.5	-	-	82-T08
E08K SCLCR/L 06	●	●	8	7.5	125	6	≥11					
E10M SCLCR/L 06	●	●	10	9.5	150	7	≥13	CC.. 09T3..	4008-M2.5x6			80-T15
E12Q SCLCR/L 06	●	●	12	11	180	9	≥16					
E16R SCLCR/L 09	●	●	16	15	200	11	≥20	CC.. 09T3..	4015-M3.5x9			80-T15
E20S SCLCR/L 09	●	●	20	19	250	13	≥24					

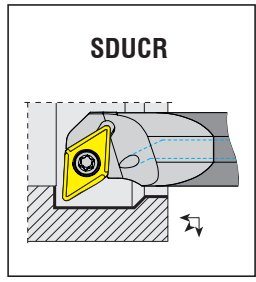
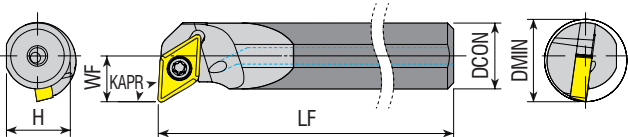

Takım Kodu Ordering Code Bestell-Bezeichnung	Stok Stock Lager		Takım Ölçüleri (mm) Dimension (mm) Abmessung (mm)				Kesici Uç Insert Wendeschneidplatte	Yedek Parçaları / Spare Parts / Ersatzteile				
	R	L	DCON	H	LF	WF		DMIN	Sıkma Vidası Screw Klemmschraube	Altlık Shim Unterlage	Altlık Vidası Shim Screw Schraube für Unterlage	Tork Anahtar Torx Key Torx Innensechskantschlüssel
	●	○										
E10M SDUCR/L 07	●	●	10	9.5	150	8	≥13	DC.. 0702..	4008-M2.5x6	-	-	82-T08
E12Q SDUCR/L 07	●	●	12	11	180	9	≥16					
E16R SDUCR/L 11	●	●	16	15	200	11	≥20	DC.. 11T3..	4015-M3.5x9	-	-	80-T15
E20S SDUCR/L 11	●	●	20	18.3	250	12	≥23					

R: Sağ / Right / Rechts L: Sol / Left / Links  
● Stokta / In Stock / Auf Lager ○ Stokta Yok / Non Stock Item / Kein Lagerartikel, Lieferzeit auf Anfrage

Sipariş Örneği/Ordering Example/Bestellbeispiel  
1 ad./pcs./stück C04G SCLCR 03

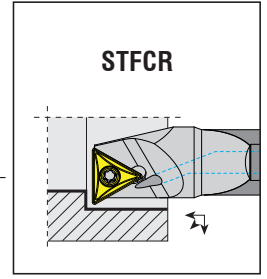
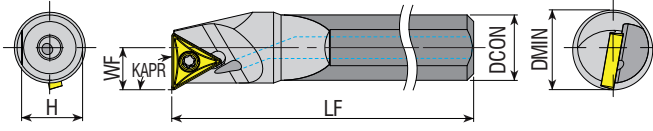

**Takım Kodu**  
**Ordering Code**  
**Bestell-Bezeichnung**

Stok Stock Lager	Takım Ölçüleri (mm) Dimension (mm) Abmessung (mm)						Kesici Uç Insert Wendeschneidplatte	Yedek Parçaları / Spare Parts / Ersatzteile					
	R	L	DCON	H	LF	WF		DMIN	Sıkma Vidası Screw Klemmschraube	Altık Shim Unterlage	Altık Vidası Shim Screw Schraube für Unterlage	Tork Anahtar Torx Key Torx Innensechskantschlüssel	
<b>new</b>	<b>E08K</b>	<b>STFCR/L 06</b>	● ○	8	7.5	125	4.5	9.5	<b>TC.. 06T1..</b>	3006-M2X4			82-T06
	<b>E10M</b>	<b>STFCR/L 09</b>	● ●	10	9.5	150	6	12	<b>TC.. 0902..</b>	3007-M2.2x5	-	-	82-T07
	<b>E12Q</b>	<b>STFCR/L 09</b>	● ●	12	11	180	8	15					82-T08
	<b>E12Q</b>	<b>STFCR/L 11</b>	● ●	12	11	180	8	15	<b>TC.. 1102..</b>	4008-M2.5x6			

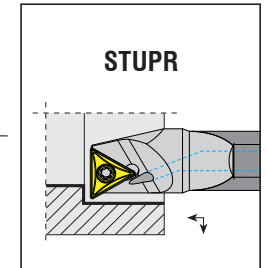
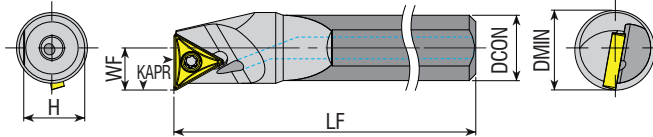

**Takım Kodu**  
**Ordering Code**  
**Bestell-Bezeichnung**

Stok Stock Lager	Takım Ölçüleri (mm) Dimension (mm) Abmessung (mm)						Kesici Uç Insert Wendeschneidplatte	Yedek Parçaları / Spare Parts / Ersatzteile					
	R	L	DCON	H	LF	WF		DMIN	Sıkma Vidası Screw Klemmschraube	Altık Shim Unterlage	Altık Vidası Shim Screw Schraube für Unterlage	Tork Anahtar Torx Key Torx Innensechskantschlüssel	
	<b>E12Q</b>	<b>STUPR/L 1103</b>	● ○	12	11	180	8	15	<b>TP. 1103..</b>	4010-M3x6	-	-	82-T10
	<b>E16R</b>	<b>STUPR/L 1103</b>	● ○	16	15	200	11	20		4010-M3x8			

R: Sağ / Right / Rechts L: Sol / Left / Links

● Stokta / In Stock / Auf Lager ○ Stokta Yok / Non Stock Item / Kein Lagerartikel, Lieferzeit auf Anfrage

Sipariş Örneği/Ordering Example/Bestellbeispiel

1 ad./pcs./stückE08K STFCR 06



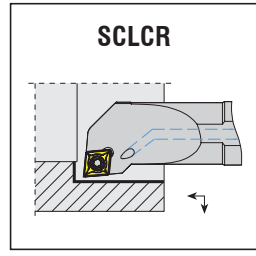
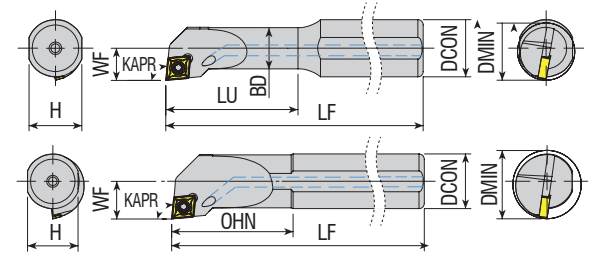

**Takım Kodu**  
**Ordering Code**  
*Bestell-Bezeichnung*

Stok Stock Lager	Takım Ölçüleri (mm) Dimension (mm) Abmessung (mm)									Kesici Uç Insert Wendeschneidplatte	Yedek Parçaları / Spare Parts / Ersatzteile			
	R	L	DCON	BD	H	LU=OHN	LF	WF	DMIN		Sıkma Vidası Screw Klemmschraube	Altlık Shim Unterlage	Altlık Vidası Shim Screw Schraube für Unterlage	Tork Anahtar Torx Key Torx Innensechskantschlüssel
A08H SCLCR/L 06	●	●	8	8	7.3	20	100	6	≥11	CC.. 0602..	4008-M2.5x6	-	-	82-T08
A10H SCLCR/L 06	●	●	10	10	9	25	100	7	≥13					
A12H SCLCR/L 06	●	●	12	12	11	25	100	9	≥16					
A16M SCLCR/L 09	●	●	16	16	14.8	35	150	11	≥20					

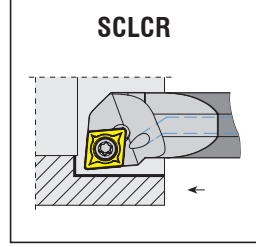
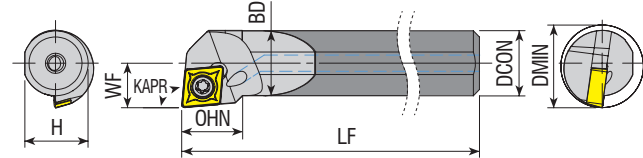

**Takım Kodu**  
**Ordering Code**  
*Bestell-Bezeichnung*

Stok Stock Lager	Takım Ölçüleri (mm) Dimension (mm) Abmessung (mm)									Kesici Uç Insert Wendeschneidplatte	Yedek Parçaları / Spare Parts / Ersatzteile			
	R	L	DCON	BD	H	OHN	LF	WF	DMIN		Sıkma Vidası Screw Klemmschraube	Altlık Shim Unterlage	Altlık Vidası Shim Screw Schraube für Unterlage	Tork Anahtar Torx Key Torx Innensechskantschlüssel
E08K SCLCR/L 06	●	●	8	8	7.5	10	125	6	≥11	CC.. 0602..	4008-M2.5x6	-	-	82-T08
E10M SCLCR/L 06	●	●	10	10	9.5	10	150	7	≥13					
E12Q SCLCR/L 06	●	●	12	12	11	12	180	9	≥16					
E16R SCLCR/L 09	●	●	16	16	15	15	200	11	≥20					

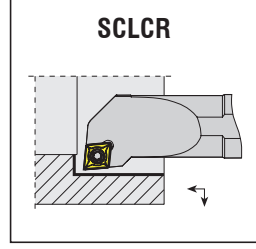
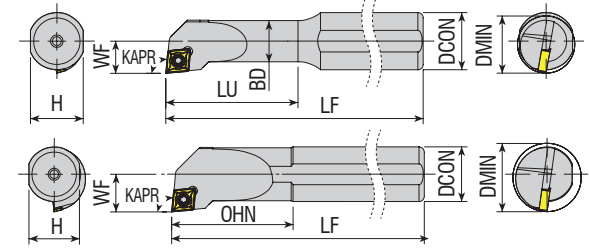

**Takım Kodu**  
**Ordering Code**  
*Bestell-Bezeichnung*

Stok Stock Lager	Takım Ölçüleri (mm) Dimension (mm) Abmessung (mm)									Kesici Uç Insert Wendeschneidplatte	Yedek Parçaları / Spare Parts / Ersatzteile			
	R	L	DCON	BD	H	LU=OHN	LF	WF	DMIN		Sıkma Vidası Screw Klemmschraube	Altlık Shim Unterlage	Altlık Vidası Shim Screw Schraube für Unterlage	Tork Anahtar Torx Key Torx Innensechskantschlüssel
S08H SCLCR/L 06	●	●	8	8	7.3	20	100	6	≥11	CC.. 0602..	4008-M2.5x6	-	-	82-T08
S10K SCLCR/L 06	●	●	10	10	9	25	125	7	≥13					
S12K SCLCR/L 06	●	●	12	12	11	25	125	9	≥16					
S16P SCLCR/L 09	●	●	16	16	14.8	35	170	11	≥20					

R: Sağ / Right / Rechts L: Sol / Left / Links  
● Stokta / In Stock / Auf Lager ○ Stokta Yok / Non Stock Item / Kein Lagerartikel, Lieferzeit auf Anfrage

Sipariş Örneği/Ordering Example/Bestellbeispiel  
1 ad./pcs./stück SET-A/SCLCR

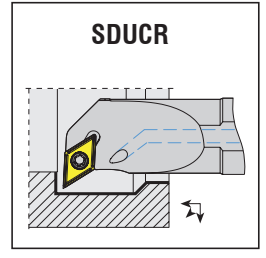
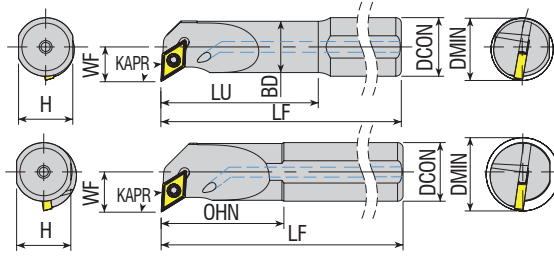

Takım Kodu Ordering Code Bestell-Bezeichnung	Stok Stock Lager	Takım Ölçüleri (mm) Dimension (mm) Abmessung (mm)							Kesici Uç Insert Wendeschneidplatte	Yedek Parçaları / Spare Parts / Ersatzteile			
		R	L	DCON	BD	H	LU=OHN	LF		WF	DMIN	Sıkma Vidası Screw Klemmschraube	Altlık Shim Unterlage
A10H SDUCR/L 07	●●	10	10	09	25	100	08	≥13	DC.. 0702..	4008-M2.5x6	-	-	82-T08
A12H SDUCR/L 07	●●	12	12	11	25	100	09	≥16					
A16M SDUCR/L 11	●●	16	16	14.8	35	150	11	≥20					

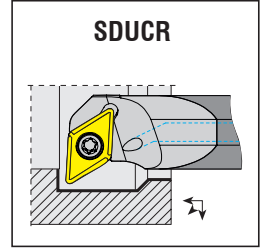
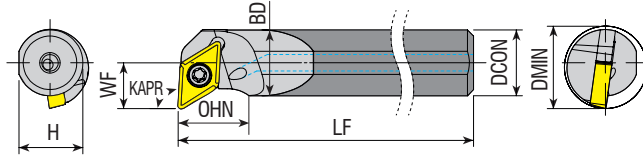

Takım Kodu Ordering Code Bestell-Bezeichnung	Stok Stock Lager	Takım Ölçüleri (mm) Dimension (mm) Abmessung (mm)							Kesici Uç Insert Wendeschneidplatte	Yedek Parçaları / Spare Parts / Ersatzteile			
		R	L	DCON	BD	H	OHN	LF		WF	DMIN	Sıkma Vidası Screw Klemmschraube	Altlık Shim Unterlage
E10M SDUCR/L 07	●○	10	10	9.5	09	150	8	≥13	DC.. 0702..	4008-M2.5x6	-	-	82-T08
E12Q SDUCR/L 07	●○	12	12	11	10	180	9	≥16					
E16R SDUCR/L 11	●○	16	16	15	12	200	11	≥20					

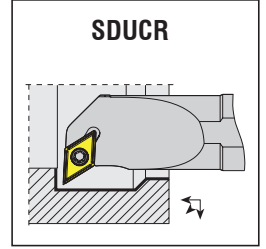
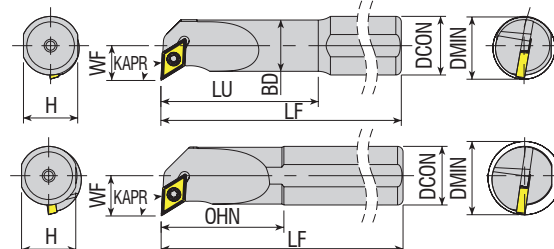

Takım Kodu Ordering Code Bestell-Bezeichnung	Stok Stock Lager	Takım Ölçüleri (mm) Dimension (mm) Abmessung (mm)							Kesici Uç Insert Wendeschneidplatte	Yedek Parçaları / Spare Parts / Ersatzteile			
		R	L	DCON	BD	H	LU=OHN	LF		WF	DMIN	Sıkma Vidası Screw Klemmschraube	Altlık Shim Unterlage
S10K SDUCR/L 07	●●	10	10	9	25	125	8	≥13	DC.. 0702..	4008-M2.5x6	-	-	82-T08
S12K SDUCR/L 07	●●	12	12	11	25	125	9	≥16					
S16P SDUCR/L 11	●●	16	16	14.8	35	170	11	≥20					

R: Sağ / Right / Rechts L: Sol / Left / Links  
● Stokta / In Stock / Auf Lager ○ Stokta Yok / Non Stock Item / Kein Lagerartikel, Lieferzeit auf Anfrage

Sipariş Örneği/Ordering Example/Bestellbeispiel  
1 ad./pcs./stück SET-A/SDUCR