



*konusulan
the spoken kalite...
quality...*

KANAL AÇMA

KANAL AÇMA TAKIMLARI
GROOVING TOOLHOLDERS
STECHHALTER





AKKO **A** **AKT** - **K** - **R** - **2525**

100 - **150** - **4** - **T22**

2 Kesici Stili / Cutter Style / Cutter-Stil

DKT: Dış Çap Kanal Açma Takımı / External Grooving Toolholders
Außen-Stechhalter
IKT: Delik İçi Kanal Açma Takımı / Internal Grooving Toolholders
Innen-Stechhalter
AKT: Dış Çap Alın Kanal Takımları / Face Grooving Toolholders
Axial-Stechhalter
LKT: L Tip Alın Kanal Açma Takımı / L Type Face Grooving Toolholders
Axial-Stechhalter L-Type

3 Uç Tipi / Insert Type / Plattenform

KRLY / MGM.
HRN / S312, S229, S224, S223
ISCR / DGN, GI, GTN
SNDVK / 123, 151, 154.91
ZCC
KM / A4.
ARN / LOMR.

TGTC / TD.

4 Kesme Yönü / Cutting Direction
Halteausführung

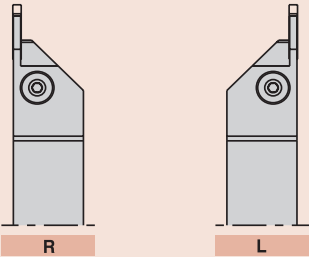

Lütfen AAKT ürünleri için kesme yönünün gösterilen tersi olduğunu unutmayın.
Please be informed that for AAKT products cutting direction is vice versa what is shown.
Bitte beachten Sie, dass die Schnittrichtung für AAKT-Produkte umgekehrt zur Darstellung ist.

5 Kesme Kenar Yüksekliği ve Şaft Genişliği
Cutting Edge Height and Shank Width
Schafthöhe und Schafbreite

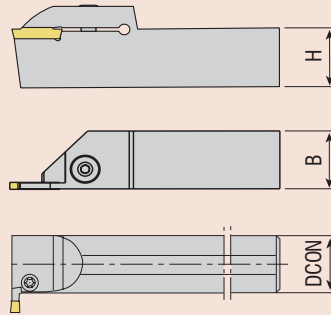

6 Kesme Aralığı
Cutting Diameter
Durchmesser für Axialeinstechen

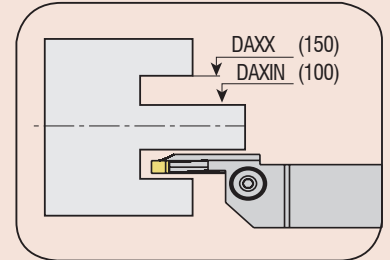

7 Kesme Kenar Genişliği / Cutting Width Edge
Plattenbreite

ÖR/E.G. :
2 = 2.0 mm
3 = 3.0 mm
4 = 4.0 mm
5 = 5.0 mm
6 = 6.0 mm
8 = 8.0 mm

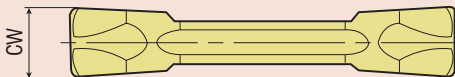

8 Kesme Derinliği / Cutting Depth / Maximale Schnitttiefe

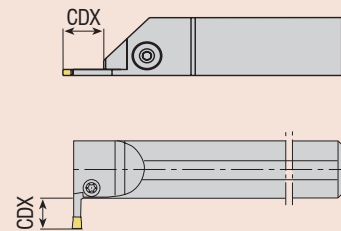

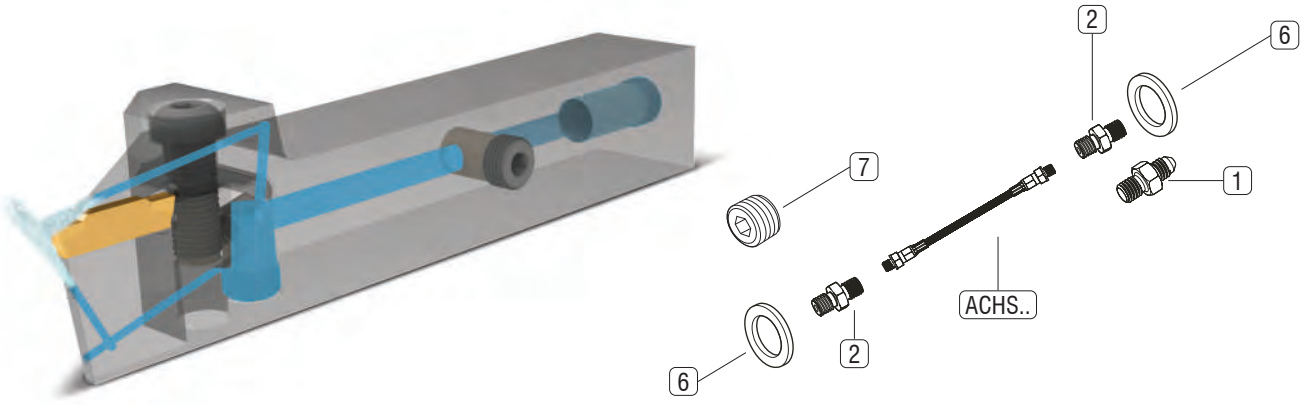

Not: İçten soğutmalı tüm torna katerlerinde kullanılacak 3 tip soğutma hortum setleri tasarlanmıştır. Takımların kullanılmasından önce, kullanılmayan bağlantıların set içindeki vida ile kapatılarak sızdırmazlığın sağlanmasına dikkat edilmelidir. Torna katerlerine yönelik soğutma hortum setleri, ACHS... 10 bar ile maksimum 150 bar basınç aralığında kullanılabilir.

Note: 3 types of cooling hose sets are designed that can be used in all internally cooled lathes. Before using the tools, care should be taken to ensure that the unused connections are closed with the screw in the set and that sealing is ensured. Cooling hose sets for lathe tools can be used in the pressure range of ACHS ... 10 bar to max 150 bar.

Note: Es wurden 3 Arten von Kühlschlauch-Sets entwickelt, die in allen intern gekühlten Drehmaschinen verwendet werden können. Vor der Verwendung der Werkzeuge sollte darauf geachtet werden, dass die nicht verwendeten Verbindungen mit der Schraube im Satz geschlossen werden und die Abdichtung gewährleistet ist. Kühlschlauchsätze für Drehmaschinen können im Druckbereich von ACHS ... 10 bar bis max. 150 bar eingesetzt werden.

Set içindeki Parçalar Parts In The Set Teile im Set				Uzunluk / Length Code / Länge Einstellen: 250		
				Set Kodu: Set Code: Code Einstellen: ACHS-1-250	Set Kodu: Set Code: Code Einstellen: ACHS-2-250	Set Kodu: Set Code: Code Einstellen: ACHS-3-250
	Resim Picture Bild	Takım Kodu Set Code Code Einstellen	Ürün Açıklaması Product Description Artikelbeschreibung			
1		AMP-01	M10 Bağlantı Elemanı M10 Fastener M10 Verschluss	1x	-	-
2		AMP-02	G 1/8" Çift Bağlantı Elemanı G 1/8" Double Fastener G 1/8" Doppelverschluss	2x	1x	-
3		AMP-03	G 1/8" Açılı Bağlantısı G 1/8" Angle Connection G 1/8" Winkelverbindung	-	1x	2x
4		AMP-04	M10" Açılı Bağlantısı M10" Angle Connection M10" Winkelverbindung	-	1x	1x
5		AMP-05	G1/4"-G1/8" Kısalma Parçası G1 / 4"-G1/8" Capillary Piece G1 / 4"-G1/8" Kapillarstück	-	1x	1x
6		AG-01	Bakır Conta Copper Gasket Kupferdichtung	2x	3x	4x
7		2705-G1/8-5.5	G1/8" Sızdırmaz Civata G1/8" Sealing Bolt G1/8" Dichtungsschraube	1x	1x	1x
8		AH-1-250	Hortum Hose Schlauch	1x	-	-
9		AH-2-250	Hortum Hose Schlauch	-	1x	-
10		AH-3-250	Hortum Hose Schlauch	-	-	1x

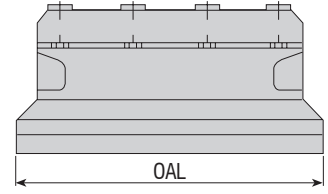
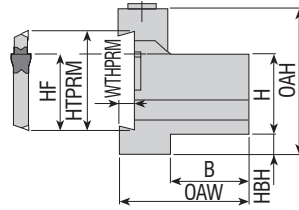

Takım Kodu Ordering Code Bestell-Bezeichnung	Stok Stock Lager	Takım Ölçüleri (mm) Dimension (mm) Abmessung (mm)									Yedek Parçaları / Spare Parts / Ersatzteile		
		HTPRM	HF	H	HBH	OAH	WTHPRM	OAL	B	OAW	Pabuç Clamp Spannspratze	Pabuç Vidası Clamp Screw Klemmschraube	Anahtar Allen Key Innensechskantschlüssel
ALBU-20-26	●	26	21.4	20	9	43	4	86	19	38	ABK-01	2505-M6x25	AAL-07-5
ALBU-25-26	●	26	21.4	25	5	45	4	110	23	42	ABK-02	2505-M6x30	
ALBU-20-32	●	32	25	20	13	50	5.3	100	19	38	ABK-03		
ALBU-25-32	●	32	25	25	8	50	5.3	110	23	42	ABK-04		
ALBU-32-32	●	32	25	32	5	54	5.3	110	29	48			

İÇTEN SU VERME KANALLI KESME VE DERİN KANAL AÇMA LAMA BLOĞU
BLOCK FOR PARTING&GROOVING TOOLS WITH INTERNAL COOLANT HOLE
BLOCK FÜR TEILUNG&AUSHOLUNG MIT INNEN KÜHLUNG

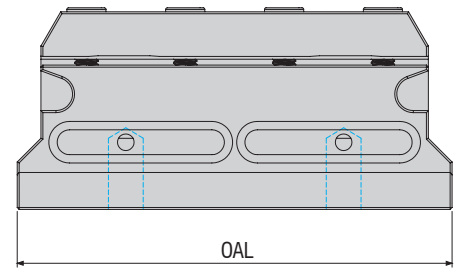
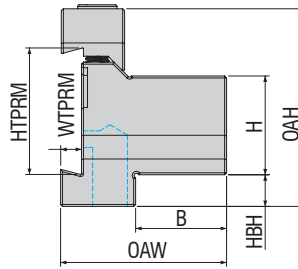

Takım Kodu Ordering Code Bestell-Bezeichnung	Stok Stock Lager	Takım Ölçüleri (mm) Dimension (mm) Abmessung (mm)									Yedek Parçaları / Spare Parts / Ersatzteile				
		HTPRM	HD	H	HBH	AOH	WTHPRM	OAL	B	OAW	Pabuç Clamp Spannspratze	Oring Ring Feder	Sızdırmaz Vida Threaded Pin Gewindestift	Pabuç Vidası Clamp Screw Klemmschraube	Anahtar Allen Key Innensechskantschlüssel
ALBU-20-32-H	●	32	20	20	13	36.50	5.30	100	19	38	ABK-03	AOR-43	2705-G1/8x5.5	2505-M6x30	AAL-07-5
ALBU-25-32-H	●	32	25	25	8	50	5.30	110	23	42	ABK-04	AOR-46			
ALBU-32-32-H	●	32	32	32	5	40.50	5.30	110	29	48	ABK-04				

R: Sağ / Right / Rechts L: Sol / Left / Links

● Stokta / In Stock / Auf Lager ○ Stokta Yok / Non Stock Item / Kein Lagerartikel, Lieferzeit auf Anfrage

Sipariş Örneği/Ordering Example/Bestellbeispiel

1 ad./pcs./stück ALBU-20-26

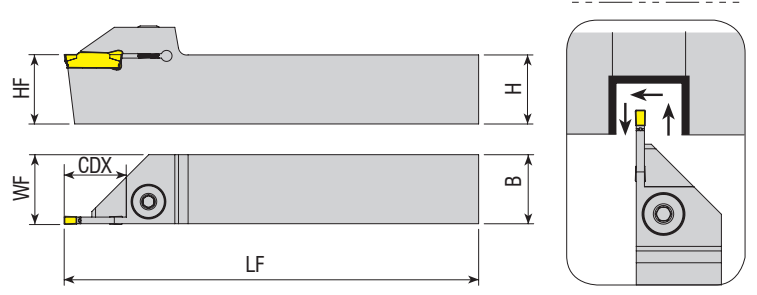

Takım Kodu
Ordering Code
Bestell-Bezeichnung

Stok
Stock
Lager

Takım Ölçüleri (mm)
Dimension (mm)
Abmessung (mm)

Kesici Uç
Insert
Wendeschneidplatte

Yedek Parçaları / Spare Parts / Ersatzteile

Sıkma Vidası
Screw
Klemmschraube

Pul
Stamp
Ring

Anahtar
Allen Key
Innensechskantschlüssel

R

L

HF=H

B

LF

WF

CDX



ADKT-K-R/L-1212-1.5-T15	●	●	12	12	100	12.2	15	AGD. -1.5	AKV-02-M6x22	ABPL-01	AAL-03-3
ADKT-K-R/L-2020-1.5-T15	●	●	20	20	125	20.2	15				
ADKT-K-R/L-1212-2-T15	●	●	12	12	100	16.3	15				
ADKT-K-R/L-1616-2-T10	●	●	16	16	125	16.3	10	AGD. -2	AKV-02-M6x22	ABPL-01	AAL-03-3
ADKT-K-R/L-1616-2-T15	●	●	16	16	125	16.3	15				
ADKT-K-R/L-2020-2-T15	●	●	20	20	150	20.3	15				
ADKT-K-R/L-2525-2-T15	●	●	25	25	150	25.3	15	AGD. -3	AKV-02-M6x22	ABPL-01	AAL-03-3
ADKT-K-R/L-3232-2-T15	●	●	32	32	170	32.3	15				
ADKT-K-R/L-1212-3-T15	●	●	12	12	100	12.3	15				
new ADKT-K-R/L-1616-3-T7	●	●	16	16	125	16.3	7	AGD. -3	AKV-02-M6x22	ABPL-01	AAL-03-3
ADKT-K-R/L-1616-3-T15	●	●	16	16	125	16.3	15				
ADKT-K-R/L-2020-3-T10	●	●	20	20	125	20.3	10				
ADKT-K-R/L-2020-3-T20	●	●	20	20	125	20.3	20	AGD. -4	2004-M8x1x20	-	AAL-05-4
ADKT-K-R/L-2020-3-R28	●	●	20	20	125	20.3	28				
ADKT-K-R/L-2525-3-T10	●	●	25	25	150	25.3	10				
ADKT-K-R/L-2525-3-R15	●	●	25	25	150	25.3	15	AGD. -4	2004-M8x1x20	-	AAL-05-4
ADKT-K-R/L-2525-3-T22	●	●	25	25	150	25.3	22				
new ADKT-K-R/L-2525-3-T30	●	●	25	25	150	25.3	30				
ADKT-K-R/L-3232-3-T10	●	●	32	32	170	32.3	10	AGD. -5	2004-M8x1x20	-	AAL-05-4
ADKT-K-R/L-3232-3-T22	●	●	32	32	170	32.3	22				
ADKT-K-R/L-2020-4-T10	●	●	20	20	125	20.4	10				
ADKT-K-R/L-2020-4-T20	●	●	20	20	125	20.4	20	AGD. -4	2004-M8x1x20	-	AAL-05-4
ADKT-K-R/L-2020-4-R25	●	○	20	20	125	20.4	25				
ADKT-K-R/L-2525-4-T10	●	●	25	25	150	25.4	10				
ADKT-K-R/L-2525-4-T18	●	●	25	25	150	25.4	18	AGD. -5	2004-M8x1x20	-	AAL-05-4
ADKT-K-R/L-2525-4-T22	●	●	25	25	150	25.4	22				
ADKT-K-R/L-3232-4-T10	●	●	32	32	170	32.4	10				
ADKT-K-R/L-3232-4-T22	●	●	32	32	170	32.4	22	AGD. -6	2004-M8x1x20	-	AAL-05-4
ADKT-K-R/L-2020-5-T20	●	●	20	20	125	20.5	20				
ADKT-K-R/L-2525-5-T15	●	●	25	25	150	25.5	15				
ADKT-K-R/L-2525-5-T18	●	●	25	25	150	25.5	18	AGD. -5	2004-M8x1x20	-	AAL-05-4
ADKT-K-R/L-2525-5-T25	●	●	25	25	150	25.5	25				
ADKT-K-R/L-3232-5-T15	●	●	32	32	170	32.5	15				
ADKT-K-R/L-3232-5-T25	●	●	32	32	170	32.5	25	AGD. -6	2004-M8x1x20	-	AAL-05-4
ADKT-K-R/L-2525-6-T15	●	●	25	25	150	25.6	15				
ADKT-K-R/L-2525-6-T25	●	●	25	25	150	25.6	25				
ADKT-K-R/L-3232-6-T25	●	●	32	32	170	32.6	25	AGD. -8	2004-M8x1x20	-	AAL-05-4
ADKT-K-R/L-3232-8-T32	●	●	32	32	170	32.8	32				

R: Sağ / Right / Rechts L: Sol / Left / Links

● Stokta / In Stock / Auf Lager ○ Stokta Yok / Non Stock Item / Kein Lagerartikel, Lieferzeit auf Anfrage

AKKO Ucuna Uygundur. / Compatible with AKKO Insert. / Kompatibel mit AKKO Wendeplatten.

Sipariş Örneği/Ordering Example/Bestellbeispiel

1 ad./pcs./stück ADKT-K-R-1212-1.5-T15

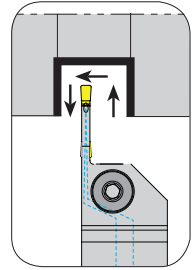
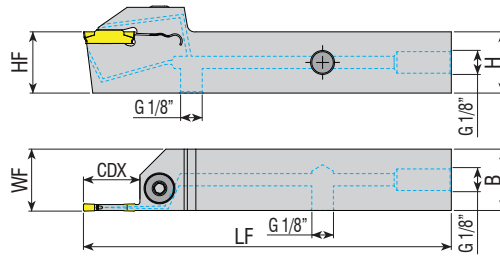

Takım Kodu
Ordering Code
Bestell-Bezeichnung

Stok
Stock
Lager

Takım Ölçüleri (mm)
Dimension (mm)
Abmessung (mm)

Kesici Uç
Insert
Wendeschneidplatte

Yedek Parçaları / Spare Parts / Ersatzteile

Sıkma Vidası
Screw
Klemmschraube

Pul
Stamp
Ring

Anahtar
Allen Key
Innensechskantschlüssel

R

L

HF=H

B

LF

WF

CDX



new

ADKT-K-R/L-1616-2-T10-H

●

○

16

16

125

16.2

10

AGD-2

AKV-02-M6x22

ABPL-01

AAL-03-3

new

ADKT-K-R/L-1616-3-T15-H

●

○

16

16

125

16.3

15

AGD-3

2004-M8x1x20

-

AAL-05-4

new

ADKT-K-R/L-2020-3-R22-H

○

●

20

20

125

20.3

22

AGD-3

2004-M8x1x20

-

AAL-05-4

ADKT-K-R/L-2020-3-T20-H

●

●

20

20

125

20.4

20

AGD-4

2004-M8x1x20

-

AAL-05-4

ADKT-K-R/L-2525-3-T22-H

●

●

25

25

150

25.4

22

AGD-4

2004-M8x1x20

-

AAL-05-4

ADKT-K-R/L-2020-4-T20-H

●

●

20

20

125

20.4

20

AGD-4

2004-M8x1x20

-

AAL-05-4

ADKT-K-R/L-2525-4-T22-H

●

●

25

25

150

25.4

22

AGD-5

2004-M8x1x20

-

AAL-05-4

ADKT-K-R/L-2525-5-T25-H

●

●

25

25

150

25.5

25

AGD-5

2004-M8x1x20

-

AAL-05-4

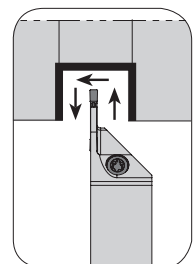
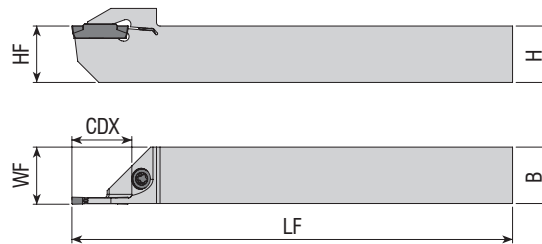

Takım Kodu
Ordering Code
Bestell-Bezeichnung

Stok
Stock
Lager

Takım Ölçüleri (mm)
Dimension (mm)
Abmessung (mm)

Kesici Uç
Insert
Wendeschneidplatte

Yedek Parçaları / Spare Parts / Ersatzteile

Sıkma Vidası
Screw
Klemmschraube

Pul
Stamp
Ring

Tork Anahtar
Torx Key
Torx Innensechskantschlüssel

R

L

HF=H

B

LF

WF

CDX



ADKT-K-R/L-1212-2-R12-K-S

●

●

12

12

125

12.20

12

AGD-2

4015-M4x11

-

80-T15

ADKT-K-R/L-1616-2-R16-K-S

●

●

16

16

125

16.20

16

AGD-2

4015-M4x11

-

80-T15

ADKT-K-R/L-1212-3-R12-K-S

●

●

12

12

125

12.30

12

AGD-3

4015-M4x11

-

80-T15

ADKT-K-R/L-1616-3-R16-K-S

●

●

16

16

125

16.30

16

AGD-3

4015-M4x11

-

80-T15

R: Sağ / Right / Rechts L: Sol / Left / Links

● Stokta / In Stock / Auf Lager ○ Stokta Yok / Non Stock Item / Kein Lagerartikel, Lieferzeit auf Anfrage

AKKO Ucuna Uygundur. / Compatible with AKKO Insert. / Kompatibel mit AKKO Wendeplatten.

Sipariş Örneği/Ordering Example/Bestellbeispiel

1 ad./pcs./stück ADKT-K-R-1616-2-T10-H

AKKO Ucuna Uygundur. / Compatible with AKKO Insert. / Kompatibel mit AKKO Wendeplatten.

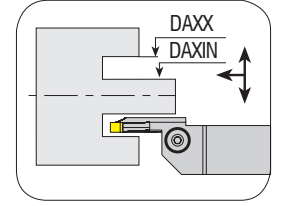
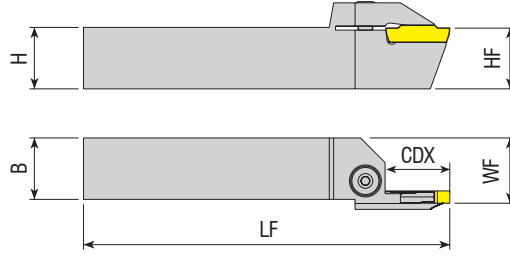

Takım Kodu
Ordering Code
Bestell-Bezeichnung

Takım Kodu Ordering Code <i>Bestell-Bezeichnung</i>	Stok Stock <i>Lager</i>		Takım Ölçüleri (mm) Dimension (mm) <i>Abmessung (mm)</i>							Kesici Uç Insert <i>Wendeschneidplatte</i>	Yedek Parçaları / Spare Parts / Ersatzteile		
	R	L	HF=H	B	LF	WF	CDX	DAXIN	DAXX	Sıkma Vidası Screw <i>Klemmschraube</i>	Pul Stamp <i>Ring</i>	Tork Anahtar Torx Key <i>Torx Innensechskantschlüssel</i>	
AAKT-K-R/L-2525-34-45-3-T17	●	●	25	25	150	26.5	17	34	45	AGD. -3			
AAKT-K-R/L-2525-39-55-3-T17	●	●	25	25	150	26.5	17	39	55				
AAKT-K-R/L-2525-49-80-3-T17	●	●	25	25	150	26.5	17	49	80				
AAKT-K-R/L-2525-70-110-3-T17	●	●	25	25	150	26.5	17	70	110				
AAKT-K-R/L-2525-100-150-3-T17	●	●	25	25	150	26.5	17	100	150				
AAKT-K-R/L-2525-80-180-3-T32	●	●	25	25	150	26.5	32	80	180				
AAKT-K-R/L-2525-175-215-3-T22	●	●	25	25	150	26.5	22	175	215				
AAKT-K-R/L-2525-700-800-3-T17	●	●	25	25	150	26.5	17	700	800				
new AAKT-K-R/L-3232-140-450-3-T17	●	●	32	32	170	33.5	17	140	450	AGD. -4	2004-M8x1x20	-	AAL-05-4
AAKT-K-R/L-2525-50-85-4-T22	●	●	25	25	150	26.5	22	50	85				
AAKT-K-R/L-2525-70-110-4-T22	●	●	25	25	150	26.5	22	70	110				
AAKT-K-R/L-2525-100-150-4-T22	●	●	25	25	150	26.5	22	100	150				
AAKT-K-R/L-2525-80-180-4-T32	●	●	25	25	150	26.5	32	80	180				
AAKT-K-R/L-2525-180-800-4-T32	●	●	25	25	150	26.5	32	180	800				
AAKT-K-R/L-2525-70-110-5-T25	●	●	25	25	150	26.5	25	70	110				
AAKT-K-R/L-2525-100-150-5-T25	●	●	25	25	150	26.5	25	100	150				
new AAKT-K-R/L-2525-100-200-5-T45	●	●	25	25	150	26.5	45	100	200	AGD. -5			
AAKT-K-R/L-2525-80-180-5-T32	●	●	25	25	150	26.5	32	80	180				
AAKT-K-R/L-2525-140-200-5-T25	●	○	25	25	150	26.5	25	140	200				
AAKT-K-R/L-2525-180-800-5-T32	●	●	25	25	150	26.5	32	180	800				
AAKT-K-R/L-2525-180-800-5-T40	●	○	25	25	150	26.5	40	180	800				
AAKT-K-R/L-2525-60-100-6-T25	●	○	25	25	150	26.5	25	60	100				
AAKT-K-R/L-2525-60-100-6-T35	●	○	25	25	150	26.5	35	60	100				
AAKT-K-R/L-2525-100-200-6-T25	●	○	25	25	150	26.5	25	100	200				
AAKT-K-R/L-2525-100-200-6-T35	●	●	25	25	150	26.5	35	100	200	AGD. -6			
AAKT-K-R/L-2525-100-200-6-T45	●	○	25	25	150	26.5	45	100	200				
AAKT-K-R/L-2525-140-300-6-T35	●	●	25	25	150	26.5	35	140	300				
AAKT-K-R/L-2525-180-360-6-T40	●	○	25	25	150	26.5	40	180	360				
new AAKT-K-R/L-3232-140-800-6-T25	○	○	32	32	170	33.5	25	140	800				
new AAKT-K-R/L-3232-180-800-6-T41	○	○	32	32	170	33.5	41	180	800				
new AAKT-K-R/L-3232-400-500-6-T25	●	○	32	32	170	33.5	25	400	500				
AAKT-K-R/L-2525-140-300-8-T35	●	○	25	25	150	26.5	35	140	300				AGD. -8
AAKT-K-R/L-3232-140-350-8-T35	●	○	32	32	150	33.5	35	140	350				

R: Sağ / Right / Rechts L: Sol / Left / Links

● Stokta / In Stock / Auf Lager ○ Stokta Yok / Non Stock Item / Kein Lagerartikel, Lieferzeit auf Anfrage

AKKO Ucuna Uygundur. / Compatible with AKKO Insert. / Kompatibel mit AKKO Wendeplatten.

Sipariş Örneği/Ordering Example/Bestellbeispiel

1 ad./pcs./stück AAKT-K-R-2525-34-45-3-T17

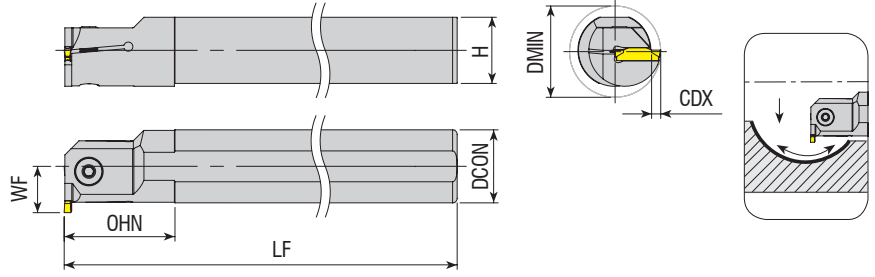

Takım Kodu
Ordering Code
Bestell-Bezeichnung

Stok
Stock
Lager

Takım Ölçüleri (mm)
Dimension (mm)
Abmessung (mm)

Kesici Uç
Insert
Wendeschneidplatte

Yedek Parçaları / Spare Parts / Ersatzteile

Sıkma Vidası
Screw
Klemmschraube

Anahtar
Allen Key
Innensechskantschlüssel

	R	L	DCON	DMIN	LF	OHN	CDX	H	WF			
AIKT-K-R/L-16-2-T4	●	●	16	21	150	28	4	14.8	12	AGD. -2	2503-M4x10 2503-M4x12 2504-M5x12	AAL-03-3
AIKT-K-R/L-20-2-T4	●	●	20	25	170	30	4	18.3	14			
AIKT-K-R/L-25-2-T6	●	●	25	32	200	40	6	23	18.5			
new AIKT-K-R/L-16-3-T7	●	●	16	25	150	28	7	14.8	15	AGD. -3	2503-M4x12 2504-M5x12 2504-M5x16 2004-M8x1x20	AAL-05-4
AIKT-K-R/L-20-3-T6	●	●	20	27	170	30	6	18.3	16			
AIKT-K-R/L-20-3-T7	●	●	20	25	170	38	7	18.3	13			
AIKT-K-R/L-25-3-T6	●	●	25	32	200	40	6	23	18.5			
AIKT-K-R/L-25-3-T10	●	●	25	32	200	48	10	23	17			
AIKT-K-R/L-32-3-T6	●	●	32	39	250	50	6	30	22			
AIKT-K-R/L-32-3-T12	●	●	32	39	250	53	12	30	22			
AIKT-K-R/L-40-3-T6	●	●	40	47	300	55	6	37.5	26			
AIKT-K-R/L-40-3-T12	●	○	40	48	300	63	12	37.5	27			
AIKT-K-R/L-20-4-T6	●	●	20	27	170	30	6	18.3	16			
AIKT-K-R/L-20-4-T7	●	○	20	25	170	38	7	18.3	13			
AIKT-K-R/L-25-4-T6	●	●	25	32	200	40	6	23	18.5			
AIKT-K-R/L-25-4-T10	●	●	25	32	200	49	10	23	17			
AIKT-K-R/L-32-4-T6	●	●	32	39	250	50	6	30	22			
AIKT-K-R/L-32-4-T12	●	●	32	39	250	53	12	30	22			
AIKT-K-R/L-40-4-T6	●	●	40	47	300	55	6	37.5	26			
AIKT-K-R/L-40-4-T12	●	●	40	48	300	63	12	37.5	27			
AIKT-K-R/L-25-5-T7	●	●	25	33	200	40	7	23	19.5	AGD. -5	2504-M5x16 2004-M8x1x20	AAL-05-4
AIKT-K-R/L-32-5-T7	●	●	32	40	250	50	7	30	23			
AIKT-K-R/L-40-5-T7	●	●	40	48	300	55	7	37.5	27			
AIKT-K-R/L-40-5-T12	●	○	40	48	300	63	12	37.5	27			

R: Sağ / Right / Rechts L: Sol / Left / Links

● Stokta / In Stock / Auf Lager ○ Stokta Yok / Non Stock Item / Kein Lagerartikel, Lieferzeit auf Anfrage

AKKO Ucuna Uygundur. / Compatible with AKKO Insert. / Kompatibel mit AKKO Wendeplatten.

Sipariş Örneği/Ordering Example/Bestellbeispiel

1 ad./pcs./stück AIKT-K-R-16-2-T4

AKKO Ucuna Uygundur. / Compatible with AKKO Insert. / Kompatibel mit AKKO Wendeplatten.

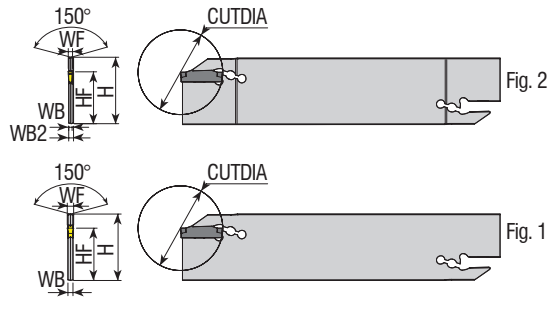

Takım Kodu Ordering Code Bestell-Bezeichnung	Stok Stock Lager	Takım Ölçüleri (mm) Dimension (mm) Abmessung (mm)								Kesici Uç Insert Wendeschneidplatte	Yedek Parçaları / Spare Parts Ersatzteile	
		H	WF	WB2	WB	I	HF	CUTDIA	Fig.		Anahtar Allen Key Innensechskantschlüssel	
AKL-K-32-2	●	32	2	2.40	1.60	150	25	32	2	AGD.-2	ALA-02	
AKL-K-32-3	●	32	3	-	2.40	150	25	42	1	AGD.-3		
AKL-K-32-4	●	32	4	-	3.20	150	25	42	1	AGD.-4		

Blok bilgileri için sayfa 155'ye gidin. / For block information, go to page 155. / Informationen zu den spannblock finden Sie auf Seite 155.

AKKO Ucuna Uygundur. / Compatible with AKKO Insert. / Kompatibel mit AKKO Wendeplatten.

ARN Ucuna Uygundur. / Compatible with ARN Insert. / Kompatibel mit ARN Wendeplatten.

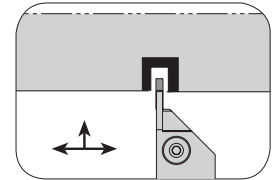
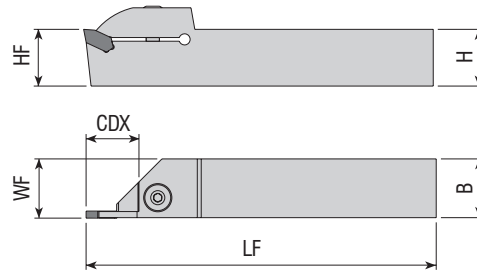

Takım Kodu Ordering Code Bestell-Bezeichnung	Stok Stock Lager		Takım Ölçüleri (mm) Dimension (mm) Abmessung (mm)					Kesici Uç Insert Wendeschneidplatte	Yedek Parçaları / Spare Parts / Ersatzteile		
	R	L	HF=H	B	LF	WF	CDX		Sıkma Vidası Screw Klemmschraube	Pul Stamp Ring	Anahtar Allen Key Innensechskantschlüssel
ADKT-ARN-R/L-2020-2-T15	●	●	20	20	125	20.3	15	LOMR.-2	AKV-02-M6x22	ABPL-01	AAL-03-3
ADKT-ARN-R/L-2525-2-T15	●	●	25	25	150	25.3	15	LOMR.-3	2004-M8x1x20	-	AAL-05-4
ADKT-ARN-R/L-2020-3-T20	●	●	20	20	125	20.4	20				
ADKT-ARN-R/L-2525-3-T22	●	●	25	25	150	25.4	22				

R: Sağ / Right / Rechts L: Sol / Left / Links

● Stokta / In Stock / Auf Lager ○ Stokta Yok / Non Stock Item / Kein Lagerartikel, Lieferzeit auf Anfrage

ARN Ucuna Uygundur. / Compatible with ARN Insert. / Kompatibel mit ARN Wendeplatten.

Sipariş Örneği/Ordering Example/Bestellbeispiel

1 ad./pcs./stück AKL-K-32-2

CRTZT Ucuna Uygundur. / Compatible with CRTZT Insert. / Kompatibel mit CRTZT Wendeplatten.

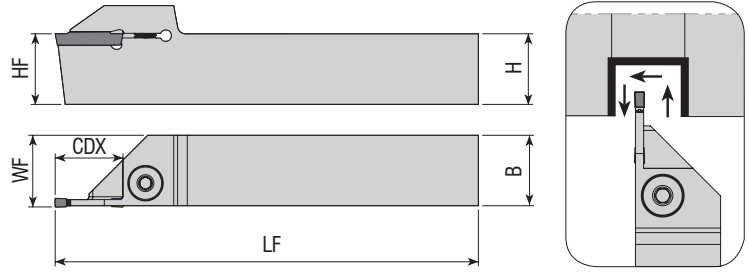

Takım Kodu Ordering Code Bestell-Bezeichnung	Stok Stock Lager		Takım Ölçüleri (mm) Dimension (mm) Abmessung (mm)					Kesici Uç Insert Wendeschneidplatte	Yedek Parçaları / Spare Parts / Ersatzteile			
	R	L	HF=H	B	LF	WF	CDX		Sıkma Vidası Screw Klemmschraube	Pul Stamp Ring	Anahtar Allen Key Innensechskantschlüssel	
ADKT-CD-R/L-2020-3-R20	●	○	20	20	125	20.3	20	GX24 0300	2004-M8x1x20	-	AAL-05-4	
ADKT-CD-R/L-2525-3-R23	●	○	25	25	150	25.3	23					

CRTZT Ucuna Uygundur. / Compatible with CRTZT Insert. / Kompatibel mit CRTZT Wendeplatten.

HRN Ucuna Uygundur. / Compatible with HRN Insert. / Kompatibel mit HRN Wendeplatten.

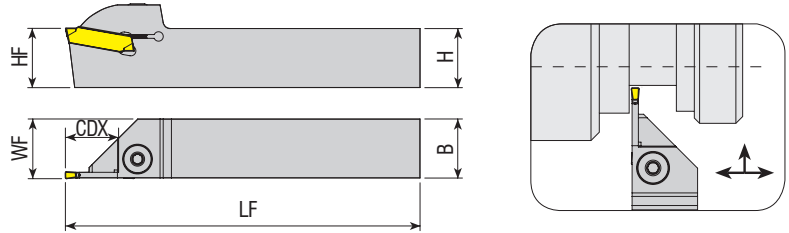

Takım Kodu Ordering Code Bestell-Bezeichnung	Stok Stock Lager		Takım Ölçüleri (mm) Dimension (mm) Abmessung (mm)					Kesici Uç Insert Wendeschneidplatte	Yedek Parçaları / Spare Parts / Ersatzteile			
	R	L	HF=H	B	LF	WF	CDX		Sıkma Vidası Screw Klemmschraube	Pul Stamp Ring	Anahtar Allen Key Innensechskantschlüssel	
ADKT-H-R/L-2020-3-T20	●	●	20	20	125	20.5	20	S229 - 3	2004-M8x1x20	-	AAL-05-4	
ADKT-H-R/L-2525-3-T22	●	●	25	25	150	25.5	22					
ADKT-H-R/L-2525-3-T26	●	●	25	25	150	25.5	26					
ADKT-H-R/L-2020-4-T20	●	●	20	20	125	20.5	20					
ADKT-H-R/L-2525-4-T22	●	●	25	25	150	25.5	22					
ADKT-H-R/L-3232-4-T22	●	●	32	32	170	32.5	22					
ADKT-H-R/L-2020-5-T20	●	●	20	20	125	20.5	20					
ADKT-H-R/L-2525-5-T25	●	●	25	25	150	25.5	25					
ADKT-H-R/L-2525-6-T25	●	●	25	25	150	25.6	25					

R: Sağ / Right / Rechts L: Sol / Left / Links

● Stokta / In Stock / Auf Lager ○ Stokta Yok / Non Stock Item / Kein Lagerartikel, Lieferzeit auf Anfrage

HRN Ucuna Uygundur. / Compatible with HRN Insert. / Kompatibel mit HRN Wendeplatten.

Sipariş Örneği/Ordering Example/Bestellbeispiel

1 ad./pcs./stück ADKT-CD-R-2020-3-R20

HRN Ucuna Uygun. / Compatible with HRN Insert. / Kompatibel mit HRN Wendeplatten.

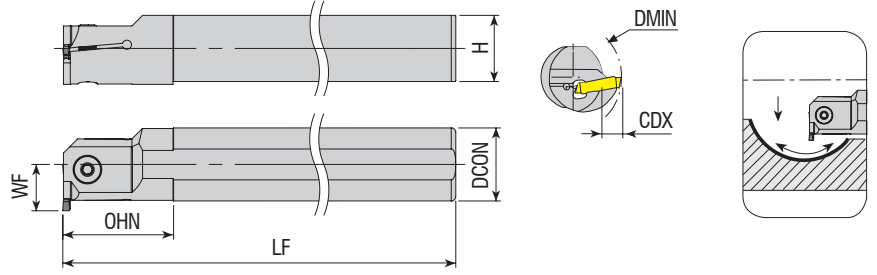

Takım Kodu Ordering Code Bestell-Bezeichnung	Stok Stock Lager		Takım Ölçüleri (mm) Dimension (mm) Abmessung (mm)							Kesici Uç Insert Wendeschneidplatte	Yedek Parçaları / Spare Parts / Ersatzteile		
	R	L	DCON	DMIN	LF	OHN	CDX	H	WF		Sıkma Vidası Screw Klemmschraube	Pul Stamp Ring	Anahtar Allen Key Innensechskantschlüssel
AIKT-H-R/L-25-3-T8	●	●	25	34	200	40	8	23	20.5	S229 - 3	2504-M5x16	AAL-05-4	
AIKT-H-R/L-32-3-T7	●	●	32	40	250	50	7	30	23		2004-M8x1x20		
AIKT-H-R/L-40-3-T7	●	●	40	48	300	55	7	37.5	27		2504-M5x16		
AIKT-H-R/L-25-4-T8	●	●	25	34	200	40	8	23	20.5	S229 - 4	2504-M5x16		
AIKT-H-R/L-32-4-T7	●	●	32	40	250	50	7	30	23		2004-M8x1x20		
AIKT-H-R/L-40-4-T7	●	●	40	48	300	55	7	37.5	27	S229 - 5	2504-M5x16		
AIKT-H-R/L-25-5-T8	●	●	25	34	200	40	8	23	20.5		2004-M8x1x20		
AIKT-H-R/L-32-5-T7	●	○	32	40	250	50	7	30	23		2004-M8x1x20		
AIKT-H-R/L-40-5-T7	●	○	40	48	300	55	7	37.5	27				

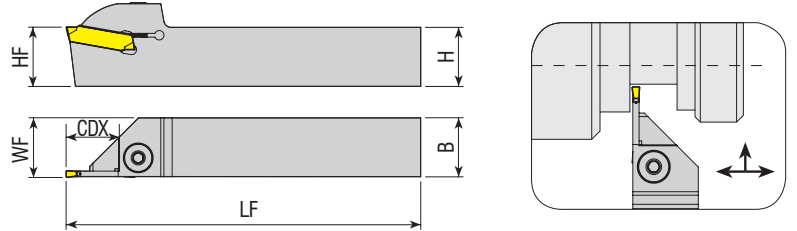

Takım Kodu Ordering Code Bestell-Bezeichnung	Stok Stock Lager		Takım Ölçüleri (mm) Dimension (mm) Abmessung (mm)					Kesici Uç Insert Wendeschneidplatte	Yedek Parçaları / Spare Parts / Ersatzteile			
	R	L	HF=H	B	LF	WF	CDX		Sıkma Vidası Screw Klemmschraube	Pul Stamp Ring	Anahtar Allen Key Innensechskantschlüssel	
ADKT-HK-R/L-1616-2-T15	●	●	16	16	125	16.3	15	S224 - 2	AKV-02-M6x22	ABPL-01	AAL-03-3	
ADKT-HK-R/L-2020-2-T15	●	●	20	20	125	20.3	15		S224 - 3	2004-M8x1x20	-	AAL-05-4
ADKT-HK-R/L-2525-2-T15	●	●	25	25	150	25.3	15					
ADKT-HK-R/L-1616-3-T15	○	○	16	16	125	16.3	15					
ADKT-HK-R/L-2020-3-T20	●	●	20	20	125	20.4	20					
ADKT-HK-R/L-2525-3-T22	●	●	25	25	150	25.4	22	S224 - 4				
ADKT-HK-R/L-2020-4-T20	●	●	20	20	125	20.4	20					
ADKT-HK-R/L-2525-4-T22	●	●	25	25	150	25.4	22	S223 - 2	AKV-02-M6x22	ABPL-01	AAL-03-3	
ADKT-HS223-R/L-2020-2-T15	●	○	20	20	125	20.4	15		S223 - 3	2004-M8x1x20	-	AAL-05-4
ADKT-HS223-R/L-2020-3-T17	●	○	20	20	125	20.3	17					

R: Sağ / Right / Rechts! L: Sol / Left / Links

● Stokta / In Stock / Auf Lager ○ Stokta Yok / Non Stock Item / Kein Lagerartikel, Lieferzeit auf Anfrage

HRN Ucuna Uygun. / Compatible with HRN Insert. / Kompatibel mit HRN Wendeplatten.

Sipariş Örneği/Ordering Example/Bestellbeispiel

1 ad./pcs./stück AIKT-H-R/L-25-3-T8

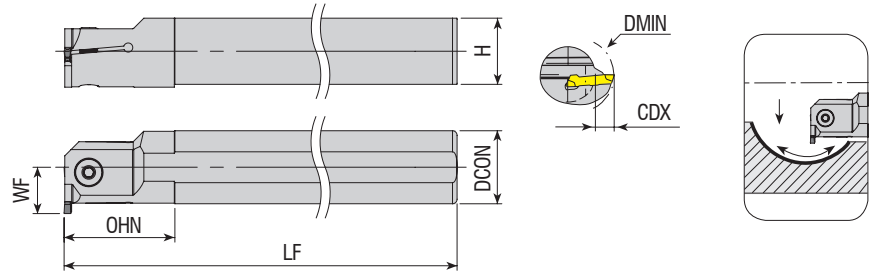

Takım Kodu Ordering Code Bestell-Bezeichnung	Stok Stock Lager		Takım Ölçüleri (mm) Dimension (mm) Abmessung (mm)							Kesici Uç Insert Wendeschneidplatte	Yedek Parçaları / Spare Parts / Ersatzteile		
	R	L	DCON	DMIN	LF	OHN	CDX	H	WF		Sıkma Vidası Screw Klemmschraube	Anahtar Allen Key Innensechskantschlüssel	
AIKT-HK-R/L-20-2-T6	●	●	20	26	170	30	6	18.3	16	S224 - 2	2503-M4x12	AAL-03-3	
AIKT-HK-R/L-25-2-T6	●	○	25	32	200	40	6	23	18.5		2504-M5x16		
AIKT-HK-R/L-20-3-T6	●	○	20	27	170	30	6	18.3	16	S224 - 3	2504-M5x12	AAL-05-4	
AIKT-HK-R/L-25-3-T6	●	●	25	32	200	40	6	23	18.5		2504-M5x16		
AIKT-HK-R/L-32-3-T6	●	●	32	39	250	50	6	30	22	S224 - 4	2004-M8x1x20	AAL-05-4	
AIKT-HK-R/L-20-4-T6	●	○	20	27	170	30	6	18.3	16		2504-M5x12		
AIKT-HK-R/L-25-4-T6	●	○	25	32	200	40	6	23	18.5	2504-M5x16	AAL-03-3		
AIKT-HK-R/L-32-4-T6	●	○	32	39	250	50	6	30	22	2004-M8x1x20			
AIKT-HS223-R/L-20-2-T5	●	○	20	26	170	33	5	18.3	15	S223 - 2	2503-M4x12	AAL-03-3	
AIKT-HS223-R/L-25-2-T5	●	○	25	31	200	40	5	23	17.5		2504-M5x16		
AIKT-HS223-R/L-20-3-T6	●	○	20	27	170	33	6	18.3	16	S223 - 3	2504-M5x12	AAL-05-4	
AIKT-HS223-R/L-25-3-T6	●	○	25	32	200	40	6	23	18.5		2504-M5x16		

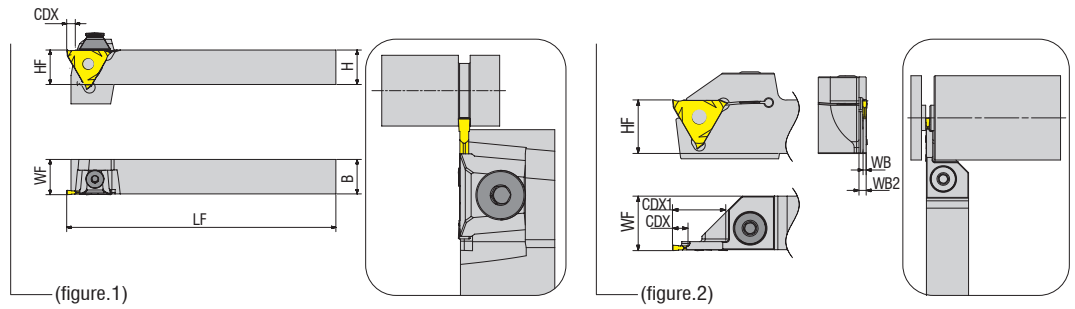

Takım Kodu Ordering Code Bestell-Bezeichnung	Stok Stock Lager		Takım Ölçüleri (mm) Dimension (mm) Abmessung (mm)								Kesici Uç Insert Wendeschneidplatte	Figür Figure Figur	Yedek Parçaları / Spare Parts / Ersatzteile				
	R	L	HF=H	B	LF	WF	WB	WB2	CDX	CDX1			Sıkma Vidası Screw Klemmschraube	Baskı Pabucu Wedge Clamp Spannpratze	Segman Ring Feder	Anahtar Allen Key Innensechskantschlüssel	
ADKT-H22-R/L-1616-(0.5-2)-T4	●	●	16	16	125	16.35	-	-	4	-	S312 - (0.5-2)	figure.1	AKV-29-M6x29	AKK-04	AS-01	AAL-03-3	
ADKT-H22-R/L-2020-(0.5-2)-T4	●	●	20	20	125	20.35	-	-	4	-			figure.2	2004-M8x1x20	-	-	AAL-05-4
ADKT-H22-R/L-2020-(0.5-2)-T6x20	●	○	20	20	125	20.2	1.3	3	6	20			figure.1	AKV-29-M6x29	AKK-04	AS-01	AAL-03-3
ADKT-H22-R/L-2525-(0.5-2)-T4	●	●	25	25	150	25.35	-	-	4	-			figure.2	2004-M8x1x20	-	-	AAL-05-4
ADKT-H22-R/L-2525-(0.5-2)-T6x20	●	○	25	25	150	20.2	1.3	3	6	20			figure.2	2004-M8x1x20	-	-	AAL-05-4

R: Sağ / Right / Rechts L: Sol / Left / Links

● Stokta / In Stock / Auf Lager ○ Stokta Yok / Non Stock Item / Kein Lagerartikel, Lieferzeit auf Anfrage

HRN Ucuna Uygundur. / Compatible with HRN Insert. / Kompatibel mit HRN Wendeplatten.

Sipariş Örneği/Ordering Example/Bestellbeispiel

1 ad./pcs./stück AIKT-HK-R-20-2-T6

ISCR Ucuna Uygundur. / Compatible with ISCR Insert. / Kompatibel mit ISCR Wendeplatten.

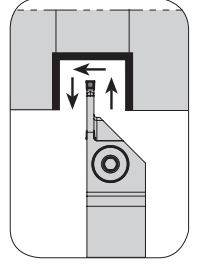
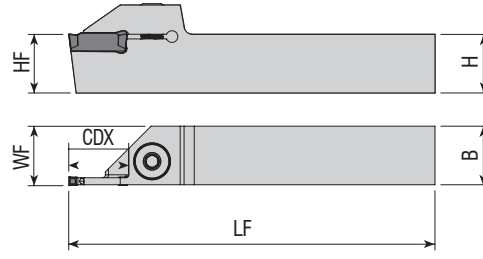

Takım Kodu Ordering Code Bestell-Bezeichnung	Stok Stock Lager		Takım Ölçüleri (mm) Dimension (mm) Abmessung (mm)				Kesici Uç Insert Wendescheidplatte	Yedek Parçaları / Spare Parts / Ersatzteile			
	R	L	HF=H	B	LF	WF		CDX	Sıkma Vidası Screw Klemmschraube	Pul Stamp Ring	Anahtar Allen Key Innensechskantschlüssel
ADKT-I-R/L-1212-2-T15	●	●	12	12	100	16.3	15	DGN - 2	AKV-02-M6x22	ABPL-01	AAL-03-3
ADKT-I-R/L-1616-2-T15	●	●	16	16	125	16.3	15				
ADKT-I-R/L-2020-2-T15	●	●	20	20	125	20.3	15				
ADKT-I-R/L-2525-2-T15	●	●	25	25	150	25.3	15				
ADKT-I-R/L-3232-2-T15	●	●	32	32	170	32.3	15				
ADKT-I-R/L-1212-3-T15	●	●	12	12	100	16.3	15	DGN - 3			
ADKT-I-R/L-1616-3-T15	●	●	16	16	125	16.3	15				
ADKT-I-R/L-2020-3-T12	●	●	20	20	125	20.3	12				
ADKT-I-R/L-2020-3-T20	●	●	20	20	125	20.3	20				
ADKT-I-R/L-2525-3-T12	●	●	25	25	150	25.3	12				
ADKT-I-R/L-2525-3-T22	●	●	25	25	150	25.3	22	DGN / GRP - 4	2004-M8x1x20	-	AAL-05-4
ADKT-I-R/L-3232-3-T22	●	●	32	32	170	32.3	22				
ADKT-I-R/L-2020-4-T20	●	●	20	20	125	20.4	20				
ADKT-I-R/L-2525-4-T12	●	●	25	25	150	25.4	12				
ADKT-I-R/L-2525-4-T22	●	●	25	25	150	25.4	22				
ADKT-I-R/L-3232-4-T25	●	●	32	32	170	32.4	25	DGN / GRP - 5			
ADKT-I-R/L-2020-5-T20	●	●	20	20	125	20.5	20				
ADKT-I-R/L-2525-5-T12	●	●	25	25	150	25.5	12				
ADKT-I-R/L-2525-5-T25	●	●	25	25	150	25.5	25				
ADKT-IG-R/L-1616-3-T18	●	○	16	16	125	16.3	18				
ADKT-IG-R/L-2020-3-T12	●	●	20	20	125	20.3	12				
ADKT-IG-R/L-2020-3-R20	●	●	20	20	125	20.3	20				
ADKT-IG-R/L-2525-3-T12	●	●	25	25	150	25.3	12				
ADKT-IG-R/L-2525-3-T22	●	●	25	25	150	25.3	22				
ADKT-IGI-R/L-2020-2-T15	●	●	20	20	125	20.3	15	GIM / GIP - 2	AKV-02-M6x22	ABPL-01	AAL-03-3
ADKT-IGI-R/L-2525-2-T15	●	●	25	25	150	25.3	15				
ADKT-IGI-R/L-1616-3-T15	●	●	16	16	125	16.3	15	GIM / GIP - 3			
ADKT-IGI-R/L-2020-3-T20	●	●	20	20	125	20.3	20				
ADKT-IGI-R/L-2525-3-T9	●	●	25	25	150	25.3	9				
ADKT-IGI-R/L-2525-3-T22	●	●	25	25	150	25.3	22				
ADKT-IGI-R/L-2525-4-T22	●	●	25	25	150	25.4	22				
ADKT-IGI-R/L-2525-5-T25	●	●	25	25	150	25.5	25	GIM / GIP - 4	2004-M8x1x20	-	
ADKT-IGI-R/L-2525-8-T25	●	○	25	25	150	25.8	25				
ADKT-IGI-R/L-2525-8-T30	●	○	25	25	150	25.8	30	GIM / GIP - 8	2505-M6x20		AAL-07-5 AAL-03-3
ADKT-IGI-R/L-2525-5-T25	●	●	25	25	150	25.6	25				
ADKT-IGTN-R/L-2525-5-T25	●	●	25	25	150	25.6	25	GTN - 5	2004-M8x1x20		
ADKT-IDC-R/L-1616-2-D35	○	●	16	16	140	16.2	35	DCE - 2	2503-M4x19	ABPL-01	AAL-05-4 AAL-03-3
ADKT-IDC-R/L-2020-2-R23	●	○	20	20	125	20.2	23				
ADKT-IDC-R/L-2525-2-R23	●	○	25	25	150	25.2	23	DCE - 3	AKV-02-M6x22		
ADKT-IDC-R/L-1616-3-D35	●	○	16	16	140	16.3	35				
ADKT-IDC-R/L-2525-3-T21	●	○	25	25	150	25.4	21		2504-M5x18		
									2004-M8x1x20	-	AAL-05-4

R: Sağ / Right / Rechts L: Sol / Left / Links

● Stokta / In Stock / Auf Lager ○ Stokta Yok / Non Stock Item / Kein Lagerartikel, Lieferzeit auf Anfrage

ISCR Ucuna Uygundur. / Compatible with ISCR Insert. / Kompatibel mit ISCR Wendeplatten.

Sipariş Örneği/Ordering Example/Bestellbeispiel

1 ad./pcs./stück ADKT-I-R-1212-2-T15

ISCR Ucuna Uygunur. / Compatible with ISCR Insert. / Kompatibel mit ISCR Wendeplatten.

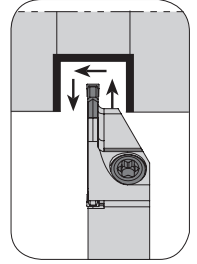
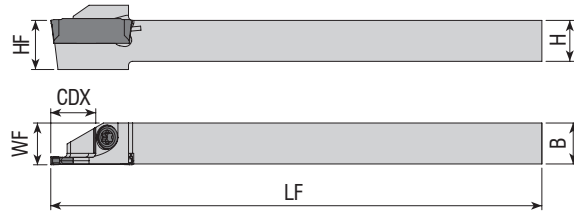

Takım Kodu Ordering Code Bestell-Bezeichnung	Stok Stock Lager		Takım Ölçüleri (mm) Dimension (mm) Abmessung (mm)					Kesici Uç Insert Wendeschneidplatte	Yedek Parçaları / Spare Parts / Ersatzteile			
	R	L	HF=H	B	LF	WF	CDX		Sıkma Vidası Screw Klemmschraube	Pul Stamp Ring	Tork Anahtar Torx Key Torx Innensechskantschlüssel	
ADKT-I-R/L-0808-2-R10-S	●	●	08	08	100	8.2	10	DGN - 2	4015-M4x11	-	80-T15	
ADKT-I-R/L-1010-2-R10-K-S	●	●	10	10	125	10.2	10					
ADKT-I-R/L-1212-2-R12-K-S	●	●	12	12	125	12.2	12					
ADKT-I-R/L-1616-2-R16-K-S	●	○	16	16	125	16.2	16	DGN - 3				
ADKT-I-R/L-1616-3-R16-K-S	●	●	16	16	125	16.3	16					

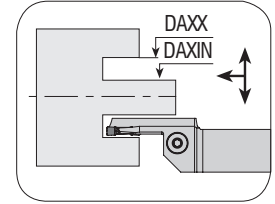
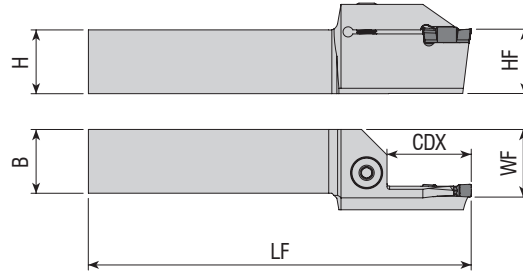

Takım Kodu Ordering Code Bestell-Bezeichnung	Stok Stock Lager		Takım Ölçüleri (mm) Dimension (mm) Abmessung (mm)							Kesici Uç Insert Wendeschneidplatte	Yedek Parçaları / Spare Parts / Ersatzteile			
	R	L	HF=H	B	LF	WF	CDX	DAXIN	DAXX		Sıkma Vidası Screw Klemmschraube	Pul Stamp Ring	Anahtar Allen Key Innensechskantschlüssel	
AAKT-IG-R/L-2525-40-60-4-T25	●	●	25	25	150	26.5	25	40	60	DGN / GRP - 4	2004-M8x1x20	-	AAL-05-4	
AAKT-IG-R/L-2525-52-80-4-T25	●	●	25	25	150	26.5	25	52	80					
AAKT-IG-R/L-2525-70-110-4-T28	●	●	25	25	150	26.5	28	70	110					
AAKT-IG-R/L-2525-72-110-4-T25	○	○	25	25	150	26.5	25	72	110					
AAKT-IG-R/L-2525-100-150-4-T25	●	○	25	25	150	26.5	25	100	150					
AAKT-IG-R/L-2525-110-200-4-T28	●	○	25	25	150	26.5	28	110	200					
AAKT-IG-R/L-2525-110-200-4-T32	●	●	25	25	150	26.5	32	110	200					
AAKT-IG-R/L-2525-140-200-4-T25	○	○	25	25	150	26.5	25	140	200					
AAKT-IG-R/L-2525-180-800-4-T28	●	●	25	25	150	26.5	28	180	800					
AAKT-IG-R/L-2525-200-800-4-T25	○	○	25	25	150	26.5	25	200	800					
AAKT-IG-R/L-2525-70-110-5-T32	●	●	25	25	150	26.5	32	70	110	DGN / GRP - 5				
AAKT-IG-R/L-2525-110-200-5-T9	●	○	25	25	150	26.5	9	110	200					
AAKT-IG-R/L-2525-110-200-5-T32	●	●	25	25	150	26.5	32	110	200					
AAKT-IG-R/L-2525-180-800-5-T32	●	●	25	25	150	26.5	32	180	800	DGN / GRP - 6				
AAKT-IG-R/L-2525-58-100-6-T32	●	○	25	25	150	26.5	32	58	100					
AAKT-IG-R/L-2525-88-180-6-T32	●	○	25	25	150	26.5	32	88	180					

R: Sağ / Right / Rechts | L: Sol / Left / Links

● Stokta / In Stock / Auf Lager ○ Stokta Yok / Non Stock Item / Kein Lagerartikel, Lieferzeit auf Anfrage

ISCR Ucuna Uygunur. / Compatible with ISCR Insert. / Kompatibel mit ISCR Wendeplatten.

Sipariş Örneği/Ordering Example/Bestellbeispiel
1 ad./pcs./stück ADKT-I-R-0808-2-R10-S

ISCR Ucuna Uygundur. / Compatible with ISCR Insert. / Kompatibel mit ISCR Wendeplatten.

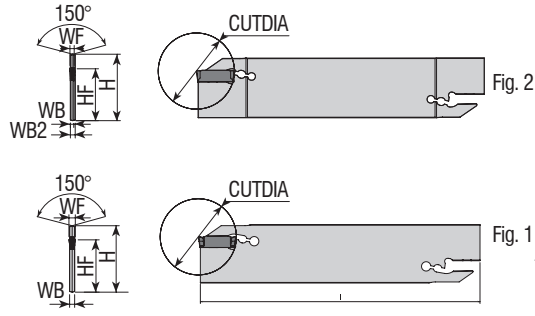

Takım Kodu Ordering Code Bestell-Bezeichnung	Stok Stock Lager	Takım Ölçüleri (mm) Dimension (mm) Abmessung (mm)								Kesici Uç Insert Wendeschneidplatte	Yedek Parçaları / Spare Parts Ersatzteile	
		H	WF	WB2	WB	I	HF	CUTDIA	Fig.		Anahtar Allen Key Innensechskantschlüssel	
AKL-I-26-2	●	26	1.9-2.5	1.6	-	110	21.4	39	1	DGN - 2	ALA-02	
AKL-I-32-2	●	32	1.9-2.5	1.6	2.4	150	25	39	2			
AKL-I-26-3	●	26	3-3.18	2.4	-	110	21.4	39	1	DGN - 3	ALA-02	
AKL-I-32-3	●	32	3-3.18	2.4	-	150	25	39	1			
AKL-I-26-4	●	26	4	3.2	-	110	21.4	80	1	DGN / GRP - 4	ALA-02	
AKL-I-32-4	●	32	4	3.2	-	150	25	100	1			

Blok bilgileri için sayfa 155'ye gidin. / For block information, go to page 155.
Informationen zu den spannblock finden Sie auf Seite 155.

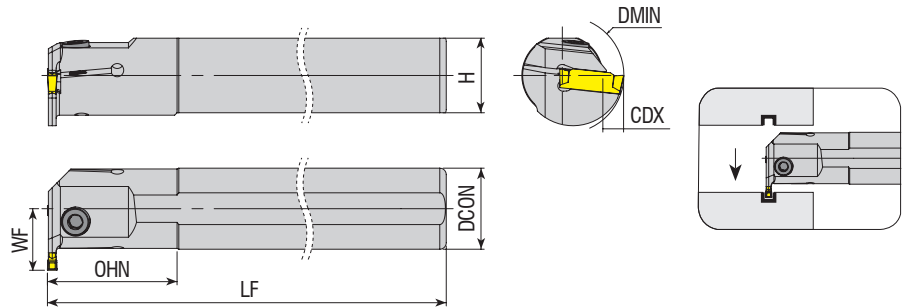

Takım Kodu Ordering Code Bestell-Bezeichnung	Stok Stock Lager		Takım Ölçüleri (mm) Dimension (mm) Abmessung (mm)							Kesici Uç Insert Wendeschneidplatte	Yedek Parçaları / Spare Parts / Ersatzteile	
	R	L	DCON	DMIN	LF	OHN	CDX	H	WF		Sıkma Vidası Screw Klemmschraube	Anahtar Allen Key Innensechskantschlüssel
AIKT-I-R/L-20-3-T5	●	●	20	26	170	25	5	18.3	15.5	DGN - 3	2504-M5x12	AAL-05-4
AIKT-I-R/L-25-3-T6	●	●	25	32	200	40	6	23	19		2504-M5x16	

R: Sağ / Right / Rechts L: Sol / Left / Links

● Stokta / In Stock / Auf Lager ○ Stokta Yok / Non Stock Item / Kein Lagerartikel, Lieferzeit auf Anfrage

ISCR Ucuna Uygundur. / Compatible with ISCR Insert. / Kompatibel mit ISCR Wendeplatten.

Sipariş Örneği/Ordering Example/Bestellbeispiel

1 ad./pcs./stück AKL-I-26-2

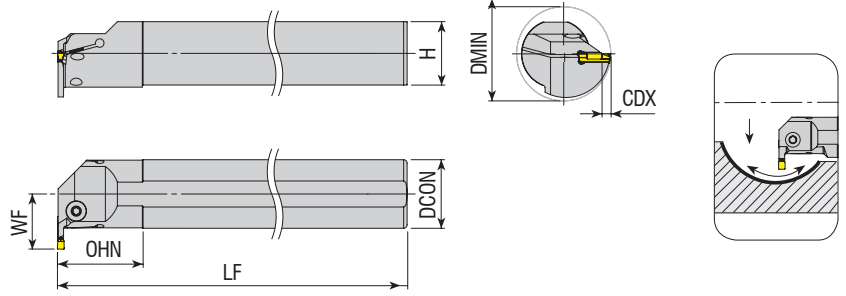

Takım Kodu Ordering Code Bestell-Bezeichnung	Stok Stock Lager		Takım Ölçüleri (mm) Dimension (mm) Abmessung (mm)						Kesici Uç Insert Wendescheidplatte	Yedek Parçaları / Spare Parts / Ersatzteile		
	R	L	DCON	DMIN	LF	OHN	CDX	H		WF	Sıkma Vidası Screw Klemmschraube	Anahtar Allen Key Innensechskantschlüssel
AIKT-IG-R/L-25-4-T10-H	●	●	25	36	200	40	10	23	22.7	DGN / GRP - 4	2504-M5X16	AAL-05-4
AIKT-IG-R/L-32-4-T10-H	●	●	32	43	250	45	10	30	26.2		2004-M8x1x20	
AIKT-IG-R/L-40-4-T12-H	●	●	40	53	250	50	12	37.5	32.2			
AIKT-IG-R/L-25-5-T10-H	●	○	25	43	200	40	10	23	22.7	DGN / GRP - 5	2504-M5X16	
AIKT-IG-R/L-32-5-T10-H	●	○	32	43	250	45	10	30	26.2		2004-M8x1x20	
AIKT-IG-R/L-40-5-T12-H	●	○	40	53	250	50	12	37.5	32.2			
AIKT-IG-R/L-50-5-T12-H	●	○	50	63	300	60	12	47	37.2			

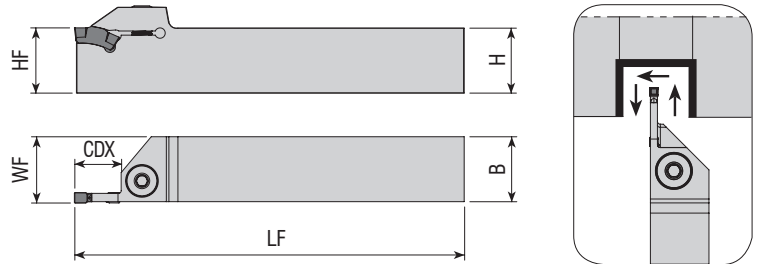

Takım Kodu Ordering Code Bestell-Bezeichnung	Stok Stock Lager		Takım Ölçüleri (mm) Dimension (mm) Abmessung (mm)				Kesici Uç Insert Wendescheidplatte	Yedek Parçaları / Spare Parts / Ersatzteile					
	R	L	HF=H	B	LF	WF		CDX	Sıkma Vidası Screw Klemmschraube	Pul Stamp Ring	Anahtar Allen Key Innensechskantschlüssel		
ADKT-ITG-R/L-20-3-T8	●	●	20	20	125	20.3	8	TGM. - 3	2004-M8x1x20	-	AAL-05-4		
ADKT-ITG-R/L-2525-3-T8	●	●	25	25	150	25.3	8						
ADKT-ITG-R/L-3232-3-T8	●	○	32	32	170	32.3	8						
ADKT-ITG-R/L-20-4-T9	●	●	20	20	125	20.4	9	TGM. - 4					
ADKT-ITG-R/L-2525-4-T17	●	●	25	25	150	25.4	17						
ADKT-ITG-R/L-3232-4-T17	●	●	32	32	170	32.4	17						
ADKT-ITG-R/L-3232-5-T25	●	○	32	32	170	32.5	25		TGM. - 5				

R: Sağ / Right / Rechts L: Sol / Left / Links
● Stokta / In Stock / Auf Lager ○ Stokta Yok / Non Stock Item / Kein Lagerartikel, Lieferzeit auf Anfrage
ISCR Ucuna Uygun. / Compatible with ISCR Insert. / Kompatibel mit ISCR Wendeplatten.

Sipariş Örneği/Ordering Example/Bestellbeispiel
1 ad./pcs./stück AIKT-IG-R-25-4-T10-H

ISCR Ucuna Uygundur. / Compatible with ISCR Insert. / Kompatibel mit ISCR Wendeplatten.

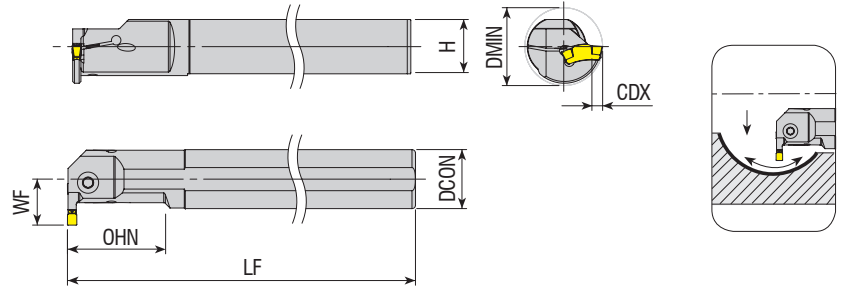

Takım Kodu Ordering Code Bestell-Bezeichnung	Stok Stock Lager		Takım Ölçüleri (mm) Dimension (mm) Abmessung (mm)							Kesici Uç Insert Wendeschneidplatte	Yedek Parçaları / Spare Parts / Ersatzteile	
	R	L	DCON	DMIN	LF	OHN	CDX	H	WF		Sıkma Vidası Screw Klemmschraube	Tork Anahtar Torx Key Torx Innenschlüssel
AIKT-ITG-R/L-16-3-T6-H	●	●	16	20	150	25	6	14.8	12	TGM. - 3	1020-M4.5X14	80-T20
AIKT-ITG-R/L-20-3-T6-H	●	●	20	25	170	32	6	18.3	14.2		1020-M4.5X16	
AIKT-ITG-R/L-25-3-T8-H	●	●	25	32	200	40	8	23	18.8		2504-M5X16	AAL-05-4
AIKT-ITG-R/L-32-3-T8-H	●	●	32	38	250	49	8	30	22		2004-M8x1x20	
AIKT-ITG-R/L-20-4-T6-H	●	●	20	25	170	33	6	18.3	14.2	TGM. - 4	1020-M4.5X16	80-T20
AIKT-ITG-R/L-25-4-T7-H	●	●	25	31	200	41	7	23	17.5		2504-M5X16	
AIKT-ITG-R/L-25-4-T9-H	●	●	25	32.5	200	41	9	23	19.5		2004-M8x1x20	AAL-05-4
AIKT-ITG-R/L-32-4-T11-H	●	●	32	42	250	50	11	30	25.5			
AIKT-ITG-R/L-40-4-T11-H	●	●	40	53	300	50	11	37.5	32	TGM. - 6.35	2004-M8x1x20	
AIKT-ITG-R/L-32-6.35-T17.5-H	●	●	32	57	250	50	17.5	30	29			

R: Sağ / Right / Rechts L: Sol / Left / Links

● Stokta / In Stock / Auf Lager ○ Stokta Yok / Non Stock Item / Kein Lagerartikel, Lieferzeit auf Anfrage

ISCR Ucuna Uygundur. / Compatible with ISCR Insert. / Kompatibel mit ISCR Wendeplatten.

Sipariş Örneği/Ordering Example/Bestellbeispiel
1 ad./pcs./stück AIKT-ITG-R-16-3-T6-H



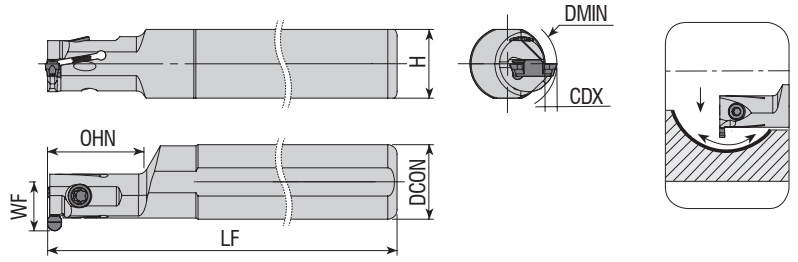

Takım Kodu Ordering Code Bestell-Bezeichnung	Stok Stock Lager		Takım Ölçüleri (mm) Dimension (mm) Abmessung (mm)							Kesici Uç Insert Wendeschneidplatte	Yedek Parçaları / Spare Parts / Ersatzteile	
	R	L	DCON	DMIN	LF	OHN	CDX	H	WF		Sıkma Vidası Screw Klemmschraube	Tork Anahtar Torx Key Torx Innensechskantschlüssel
AIKT-IGE-R/L-10-2-T3-H	●	○	10	11.5	125	25	3	9	8.3	GEPI - 2	3008-M3x8	82-T08
AIKT-IGE-R/L-16-2-T3-D11.5	●	○	16	11.5	125	20	3	14.8	11.1			
AIKT-IGE-R/L-16-2-T3-D11.5-H	●	○	16	11	125	22	3	14.8	11			
AIKT-IGE-R/L-16-2-T2.5-H	●	●	16	13	125	20	2.5	14.8	10.5	GEPI - 3	1315-M4x11	82-T15
AIKT-IGE-R/L-20-2-T4-H	●	○	20	20	170	41	4	18.3	14			
AIKT-IGE-R/L-16-3-T2.5-H	●	○	16	13	125	20	2.5	14.8	10.5			
AIKT-IGE-R/L-16-3-T2.5-D20	●	○	16	20	125	28	2.5	14.8	10.5			80-T15

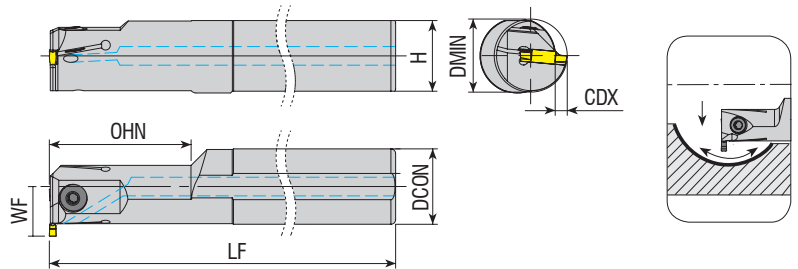

Takım Kodu Ordering Code Bestell-Bezeichnung	Stok Stock Lager		Takım Ölçüleri (mm) Dimension (mm) Abmessung (mm)							Kesici Uç Insert Wendeschneidplatte	Yedek Parçaları / Spare Parts / Ersatzteile	
	R	L	DCON	DMIN	LF	OHN	CDX	H	WF		Sıkma Vidası Screw Klemmschraube	Tork Anahtar Torx Key Innensechskantschlüssel Anahtar Allen Key Innensechskantschlüssel
AIKT-IGI-R/L-20-3-T4	●	●	20	20	170	25	4	18.3	14.5	GIMIY / GIPI - 3	1020-M5x14	80-T20
AIKT-IGI-R/L-25-3-T5	●	●	25	23	200	30	5	23	17			
AIKT-IGI-R/L-32-3-T5	●	●	32	31	250	30	5	30	21			
AIKT-IGI-R/L-40-3-T5	●	○	40	50	300	50	5	37.5	25		2004-M8x1x20	AAL-05-4
AIKT-IGI-R/L-20-4-T4	●	●	20	20	170	25	4	18.3	14.5	GIMIY / GIPI - 4	1020-M5x14	80-T20
AIKT-IGI-R/L-25-5-T10	●	○	25	32	200	25	10	23	22.5	GIMIY / GIPI - 5	2504-M5x16	AAL-05-4
AIKT-IGI-R/L-25-5-T10-H	●	○	25	32	200	25	10	23	22.5			
AIKT-IGI-R/L-25-5-T15	●	○	25	37	200	25	15	23	27.5			
AIKT-IGI-R/L-25-5-T15-H	●	○	25	37	200	25	15	23	27.5			

R: Sağ / Right / Rechts L: Sol / Left / Links

● Stokta / In Stock / Auf Lager ○ Stokta Yok / Non Stock Item / Kein Lagerartikel, Lieferzeit auf Anfrage

ISCR Ucuna Uygundur. / Compatible with ISCR Insert. / Kompatibel mit ISCR Wendeplatten.

Sipariş Örneği/Ordering Example/Bestellbeispiel
1 ad./pcs./stück AIKT-IGE-R-10-2-T3-H

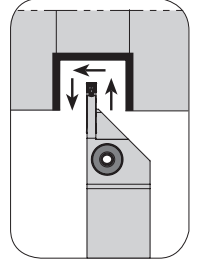
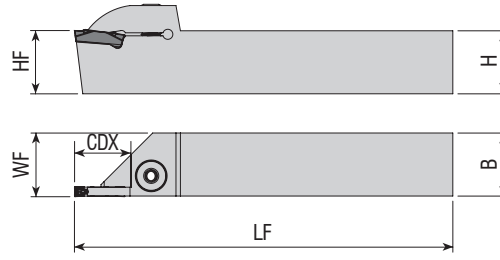

Takım Kodu Ordering Code Bestell-Bezeichnung	Stok Stock Lager		Takım Ölçüleri (mm) Dimension (mm) Abmessung (mm)				Kesici Uç Insert Wendeschneidplatte	Yedek Parçaları / Spare Parts / Ersatzteile			
	R	L	HF=H	B	LF	WF		CDX	Sıkma Vidası Screw Klemmschraube	Pul Stamp Ring	Anahtar Allen Key Innensechskantschlüssel
ADKT-KM-R/L-2020-2-T15	●	●	20	20	125	20.3	15	A4. - 2	AKV-02-M6x22	ABPL-01	AAL-03-3
ADKT-KM-R/L-2525-2-T15	●	●	25	25	150	25.3	15	A4. - 3	2004-M8x1x20	-	AAL-05-4
ADKT-KM-R/L-2020-3-T20	●	●	20	20	125	20.4	20	A4. - 4			
ADKT-KM-R/L-2525-3-T22	●	●	25	25	150	25.4	22				
ADKT-KM-R/L-2525-4-T22	●	●	25	25	150	25.5	22				

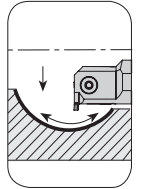
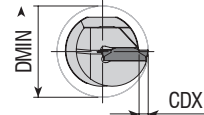
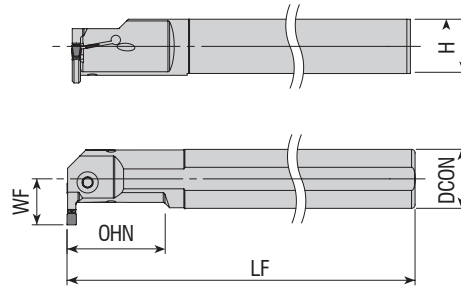

Takım Kodu Ordering Code Bestell-Bezeichnung	Stok Stock Lager		Takım Ölçüleri (mm) Dimension (mm) Abmessung (mm)						Kesici Uç Insert Wendeschneidplatte	Yedek Parçaları / Spare Parts / Ersatzteile		
	R	L	DCON	DMIN	LF	OHN	CDX	H		WF	Sıkma Vidası Screw Klemmschraube	Anahtar Allen Key Innensechskantschlüssel
AIKT-KM-R/L-20-2-T7	●	●	20	25	170	40	7	18.3	13	A4. - 2	2503-M4x12	AAL-03-3
AIKT-KM-R/L-20-3-T7	●	○	20	25	170	40	7	18.3	13	A4. - 3	2504-M5x12	AAL-05-4
AIKT-KM-R/L-25-3-T10	●	●	25	32	200	50	10	23	17	A4. - 4	2505-M6x16	AAL-07-5
AIKT-KM-R/L-32-3-T12	●	●	32	40	250	64	12	30	22		2505-M6x20	
AIKT-KM-R/L-40-3-T12	●	●	40	48	300	80	12	37.5	27		2504-M5x12	AAL-05-4
AIKT-KM-R/L-20-4-T7	●	○	20	25	170	40	7	18.3	13		2504-M5x14	
AIKT-KM-R/L-32-4-T12.2-H	●	○	32	40	190	104	12.2	31	22			

R: Sağ / Right / Rechts L: Sol / Left / Links

● Stokta / In Stock / Auf Lager ○ Stokta Yok / Non Stock Item / Kein Lagerartikel, Lieferzeit auf Anfrage

KNMTL Ucuna Uygundur. / Compatible with KNMTL Insert. / Kompatibel mit KNMTL Wendeplatten.

Sipariş Örneği/Ordering Example/Bestellbeispiel

1 ad./pcs./stück ADKT-KM-R-2020-2-T15

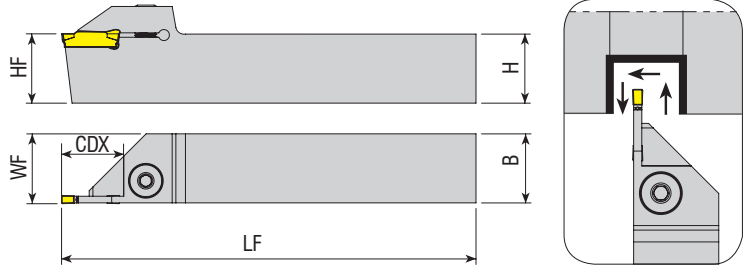

Takım Kodu
Ordering Code
Bestell-Bezeichnung

Stok Stock Lager	Takım Ölçüleri (mm) Dimension (mm) Abmessung (mm)						Kesici Uç Insert Wendeschneidplatte	Yedek Parçaları / Spare Parts / Ersatzteile			
	R	L	HF=H	B	LF	WF		CDX	Sıkma Vidası Screw Klemmschraube	Pul Stamp Ring	Anahtar Allen Key Innensechskantschlüssel
	●	●	12	12	100	12.2	15	MGM. - 1.5	AKV-02-M6x22	ABPL-01	AAL-03-3
	●	●	20	20	125	20.2	15				
	●	●	12	12	100	16.3	15				
	●	●	16	16	125	16.3	10				
	●	●	16	16	125	16.3	15				
	●	●	20	20	150	20.3	15				
	●	●	25	25	150	25.3	15				
	●	●	32	32	170	32.3	15				
	●	●	12	12	100	12.3	15	MGM. - 3	2004-M8x1x20	-	AAL-05-4
new	●	●	16	16	125	16.3	7				
	●	●	16	16	125	16.3	15				
	●	●	20	20	125	20.3	10				
	●	●	20	20	125	20.3	20				
	●	●	20	20	125	20.3	28				
	●	●	25	25	150	25.3	10				
	●	●	25	25	150	25.3	15				
	●	●	25	25	150	25.3	22				
new	●	●	16	16	150	25.3	30				
	●	●	32	32	170	32.3	10				
	●	●	32	32	170	32.3	22				
	●	●	20	20	125	20.4	10				
	●	●	20	20	125	20.4	20				
	●	○	20	20	125	20.4	25				
	●	●	25	25	150	25.4	10				
	●	●	25	25	150	25.4	18				
	●	●	25	25	150	25.4	22				
	●	●	32	32	170	32.4	10				
	●	●	32	32	170	32.4	22				
	●	●	20	20	125	20.5	20				
	●	●	25	25	150	25.5	15				
	●	●	25	25	150	25.5	18				
	●	●	25	25	150	25.5	25				
	●	●	32	32	170	32.5	15				
	●	●	32	32	170	32.5	25				
	●	●	25	25	150	25.6	15				
	●	●	25	25	150	25.6	25				
	●	●	32	32	170	32.6	25				
	●	●	32	32	170	32.8	32				

R: Sağ / Right / Rechts L: Sol / Left / Links

● Stokta / In Stock / Auf Lager ○ Stokta Yok / Non Stock Item / Kein Lagerartikel, Lieferzeit auf Anfrage

KRLY Ucuna Uygundur. / Compatible with KRLY Insert. / Kompatibel mit KRLY Wendeplatten.

Sipariş Örneği/Ordering Example/Bestellbeispiel
1 ad./pcs./stück ADKT-K-R-1212-1.5-T15

KRLY Ucuna Uygun. / Compatible with KRLY Insert. / Kompatibel mit KRLY Wendeplatten.

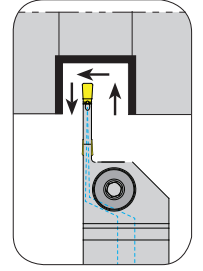
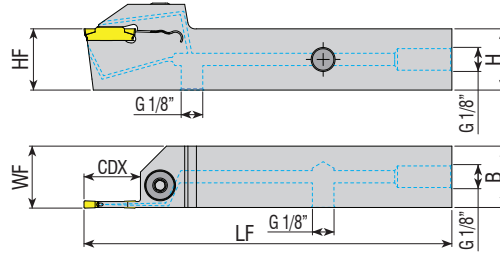

Takım Kodu
Ordering Code
Bestell-Bezeichnung

Stok
Stock
Lager

R

L

HF=H

B

LF

WF

CDX

Kesici Uç
Insert
Wendeschneidplatte



Yedek Parçaları / Spare Parts / Ersatzteile

Sıkma Vidası
Screw
Klemmschraube



Pul
Stamp
Ring



Anahtar
Allen Key
Innensechskantschlüssel



new

ADKT-K-R/L-1616-2-T10-H

●

○

16

16

125

16.2

10

MGM. -2

AKV-02-M6x22

ABPL-01

AAL-03-3

new

ADKT-K-R/L-1616-3-T15-H

●

○

16

16

125

16.3

15

MGM. -3

2004-M8x1x20

-

AAL-05-4

new

ADKT-K-R/L-2020-3-R22-H

○

●

20

20

125

20.3

22

MGM. -3

2004-M8x1x20

-

AAL-05-4

ADKT-K-R/L-2020-3-T20-H

●

●

20

20

125

20.4

20

MGM. -4

2004-M8x1x20

-

AAL-05-4

ADKT-K-R/L-2525-3-T22-H

●

●

25

25

150

25.4

22

MGM. -4

2004-M8x1x20

-

AAL-05-4

ADKT-K-R/L-2020-4-T20-H

●

●

20

20

125

20.4

20

MGM. -4

2004-M8x1x20

-

AAL-05-4

ADKT-K-R/L-2525-4-T22-H

●

●

25

25

150

25.4

22

MGM. -4

2004-M8x1x20

-

AAL-05-4

ADKT-K-R/L-2525-5-T25-H

●

●

25

25

150

25.5

25

MGM. -4

2004-M8x1x20

-

AAL-05-4

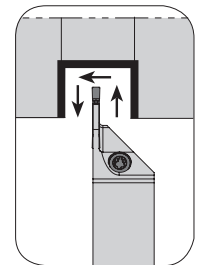
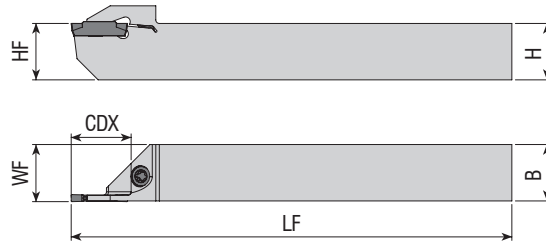

Takım Kodu
Ordering Code
Bestell-Bezeichnung

Stok
Stock
Lager

R

L

HF=H

B

LF

WF

CDX

Kesici Uç
Insert
Wendeschneidplatte



Yedek Parçaları / Spare Parts / Ersatzteile

Sıkma Vidası
Screw
Klemmschraube



Pul
Stamp
Ring



Tork Anahtar
Torx Key
Torx Innensechskantschlüssel



ADKT-K-R/L-1212-2-R12-K-S

●

●

12

12

125

12.20

12

MGM. -2

4015-M4x11

-

80-T15

ADKT-K-R/L-1616-2-R16-K-S

●

●

16

16

125

16.20

16

MGM. -2

4015-M4x11

-

80-T15

ADKT-K-R/L-1212-3-R12-K-S

●

●

12

12

125

12.30

12

MGM. -3

4015-M4x11

-

80-T15

ADKT-K-R/L-1616-3-R16-K-S

●

●

16

16

125

16.30

16

MGM. -3

4015-M4x11

-

80-T15

R: Sağ / Right / Rechts L: Sol / Left / Links

● Stokta / In Stock / Auf Lager ○ Stokta Yok / Non Stock Item / Kein Lagerartikel, Lieferzeit auf Anfrage

KRLY Ucuna Uygun. / Compatible with KRLY Insert. / Kompatibel mit KRLY Wendeplatten.

Sipariş Örneği/Ordering Example/Bestellbeispiel

1 ad./pcs./stück ADKT-K-R/L-1616-2-T10-H

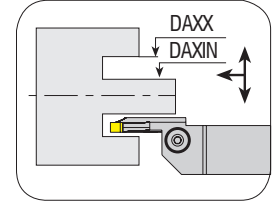
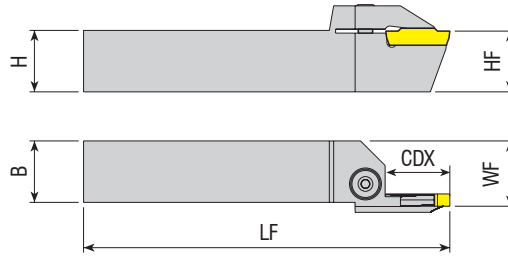

Takım Kodu Ordering Code Bestell-Bezeichnung	Stok Stock Lager		Takım Ölçüleri (mm) Dimension (mm) Abmessung (mm)							Kesici Uç Insert Wendeschneidplatte	Yedek Parçaları / Spare Parts / Ersatzteile			
	R	L	HF=H	B	LF	WF	CDX	DAXIN	DAXX	Sıkma Vidası Screw Klemmschraube	Pul Stamp Ring	Tork Anahtar Torx Key Torx Innensechskantschlüssel		
AAKT-K-R/L-2525-34-45-3-T17	●	●	25	25	150	26.5	17	34	45	MGM. - 3				
AAKT-K-R/L-2525-39-55-3-T17	●	●	25	25	150	26.5	17	39	55					
AAKT-K-R/L-2525-49-80-3-T17	●	●	25	25	150	26.5	17	49	80					
AAKT-K-R/L-2525-70-110-3-T17	●	●	25	25	150	26.5	17	70	110					
AAKT-K-R/L-2525-100-150-3-T17	●	●	25	25	150	26.5	17	100	150					
AAKT-K-R/L-2525-80-180-3-T32	●	●	25	25	150	26.5	32	80	180					
AAKT-K-R/L-2525-175-215-3-T22	●	●	25	25	150	26.5	22	175	215					
AAKT-K-R/L-2525-700-800-3-T17	●	●	25	25	150	26.5	17	700	800					
new AAKT-K-R/L-3232-140-450-3-T17	●	●	32	32	170	33.5	17	140	450	MGM. - 4	2004-M8x1x20	-	AAL-05-4	
AAKT-K-R/L-2525-50-85-4-T22	●	●	25	25	150	26.5	22	50	85					
AAKT-K-R/L-2525-70-110-4-T22	●	●	25	25	150	26.5	22	70	110					
AAKT-K-R/L-2525-100-150-4-T22	●	●	25	25	150	26.5	22	100	150					
AAKT-K-R/L-2525-80-180-4-T32	●	●	25	25	150	26.5	32	80	180					
AAKT-K-R/L-2525-180-800-4-T32	●	●	25	25	150	26.5	32	180	800					
AAKT-K-R/L-2525-70-110-5-T25	●	●	25	25	150	26.5	25	70	110					
AAKT-K-R/L-2525-100-150-5-T25	●	●	25	25	150	26.5	25	100	150					
new AAKT-K-R/L-2525-100-200-5-T45	●	●	25	25	150	26.5	45	100	200	MGM. - 5				
AAKT-K-R/L-2525-80-180-5-T32	●	●	25	25	150	26.5	32	80	180					
AAKT-K-R/L-2525-140-200-5-T25	●	○	25	25	150	26.5	25	140	200					
AAKT-K-R/L-2525-180-800-5-T32	●	●	25	25	150	26.5	32	180	800					
AAKT-K-R/L-2525-180-800-5-T40	●	○	25	25	150	26.5	40	180	800					
AAKT-K-R/L-2525-60-100-6-T25	●	○	25	25	150	26.5	25	60	100					
AAKT-K-R/L-2525-60-100-6-T35	●	○	25	25	150	26.5	35	60	100					
AAKT-K-R/L-2525-100-200-6-T25	●	○	25	25	150	26.5	25	100	200					
AAKT-K-R/L-2525-100-200-6-T35	●	●	25	25	150	26.5	35	100	200	MGM. - 6				
AAKT-K-R/L-2525-100-200-6-T45	●	○	25	25	150	26.5	45	100	200					
AAKT-K-R/L-2525-140-300-6-T35	●	●	25	25	150	26.5	35	140	300					
AAKT-K-R/L-2525-180-360-6-T40	●	○	25	25	150	26.5	40	180	360					
new AAKT-K-R-3232-140-800-6-T25	○	○	32	32	170	33.5	25	140	800					
new AAKT-K-R-3232-180-800-6-T41	○	○	32	32	170	33.5	41	180	800					
new AAKT-K-R-3232-400-500-6-T25	●	○	32	32	170	33.5	25	400	500					
AAKT-K-R/L-2525-140-300-8-T35	●	○	25	25	150	26.5	35	140	300					MGM. - 8
AAKT-K-R/L-3232-140-350-8-T35	●	○	32	32	150	33.5	35	140	350					

R: Sağ / Right / Rechts L: Sol / Left / Links

● Stokta / In Stock / Auf Lager ○ Stokta Yok / Non Stock Item / Kein Lagerartikel, Lieferzeit auf Anfrage

KRPLY Ucuna Uygundur. / Compatible with KRPLY Insert. / Kompatibel mit KRPLY Wendeplatten.

Sipariş Örneği/Ordering Example/Bestellbeispiel

1 ad./pcs./stück AAKT-K-R-2525-34-45-3-T17

KRRLY Ucuna Uygun. / Compatible with KRRLY Insert. / Kompatibel mit KRRLY Wendeplatten.

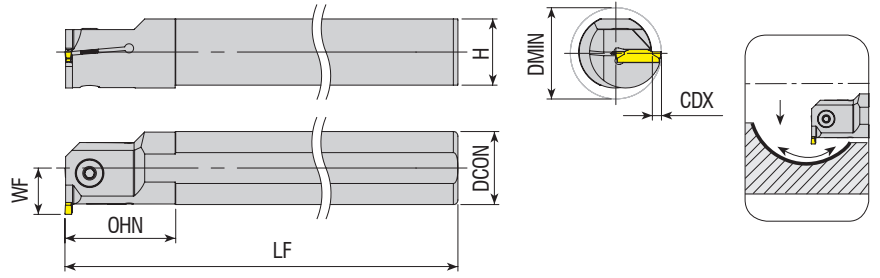

Takım Kodu Ordering Code Bestell-Bezeichnung	Stok Stock Lager		Takım Ölçüleri (mm) Dimension (mm) Abmessung (mm)							Kesici Uç Insert Wendeschneidplatte	Yedek Parçaları / Spare Parts / Ersatzteile	
	R	L	DCON	DMIN	LF	OHN	CDX	H	WF		Sıkma Vidası Screw Klemmschraube	Anahtar Allen Key Innensechskantschlüssel
AIKT-K-R/L-16-2-T4	●	●	16	21	150	28	4	14.8	12	MGM. - 2	2503-M4x10	AAL-03-3
AIKT-K-R/L-20-2-T4	●	●	20	25	170	30	4	18.3	14		2503-M4x12	
AIKT-K-R/L-25-2-T6	●	●	25	32	200	40	6	23	18.5		2504-M5x12	
new AIKT-K-R/L-16-3-T7	●	●	16	25	150	28	7	14.8	15	MGM. - 3	2503-M4x12	AAL-05-4
AIKT-K-R/L-20-3-T6	●	●	20	27	170	30	6	18.3	16		2504-M5x12	
AIKT-K-R/L-20-3-T7	●	●	20	25	170	38	7	18.3	13		2504-M5x16	
AIKT-K-R/L-25-3-T6	●	●	25	32	200	40	6	23	18.5		2004-M8x1x20	
AIKT-K-R/L-25-3-T10	●	●	25	32	200	48	10	23	17		2504-M5x12	
AIKT-K-R/L-32-3-T6	●	●	32	39	250	50	6	30	22		2504-M5x16	
AIKT-K-R/L-32-3-T12	●	●	32	39	250	53	12	30	22		2004-M8x1x20	
AIKT-K-R/L-40-3-T6	●	●	40	47	300	55	6	37.5	26		2504-M5x12	
AIKT-K-R/L-40-3-T12	●	○	40	48	300	63	12	37.5	27		2504-M5x16	
AIKT-K-R/L-20-4-T6	●	●	20	27	170	30	6	18.3	16		MGM. - 4	
AIKT-K-R/L-20-4-T7	●	○	20	25	170	38	7	18.3	13	2504-M5x16		
AIKT-K-R/L-25-4-T6	●	●	25	32	200	40	6	23	18.5	2004-M8x1x20		
AIKT-K-R/L-25-4-T10	●	●	25	32	200	49	10	23	17	2504-M5x12		
AIKT-K-R/L-32-4-T6	●	●	32	39	250	50	6	30	22	2504-M5x16		
AIKT-K-R/L-32-4-T12	●	●	32	39	250	53	12	30	22	2004-M8x1x20		
AIKT-K-R/L-40-4-T6	●	●	40	47	300	55	6	37.5	26	2504-M5x16		
AIKT-K-R/L-40-4-T12	●	●	40	48	300	63	12	37.5	27	2004-M8x1x20		
AIKT-K-R/L-25-5-T7	●	●	25	33	200	40	7	23	19.5	MGM. - 5	AAL-05-4	
AIKT-K-R/L-32-5-T7	●	●	32	40	250	50	7	30	23			2504-M5x16
AIKT-K-R/L-40-5-T7	●	●	40	48	300	55	7	37.5	27			2004-M8x1x20
AIKT-K-R/L-40-5-T12	●	○	40	48	300	63	12	37.5	27			2004-M8x1x20

R: Sağ / Right / Rechts L: Sol / Left / Links

● Stokta / In Stock / Auf Lager ○ Stokta Yok / Non Stock Item / Kein Lagerartikel, Lieferzeit auf Anfrage

KRRLY Ucuna Uygun. / Compatible with KRRLY Insert. / Kompatibel mit KRRLY Wendeplatten.

Sipariş Örneği/Ordering Example/Bestellbeispiel

1 ad./pcs./stück AIKT-K-R-16-2-T4

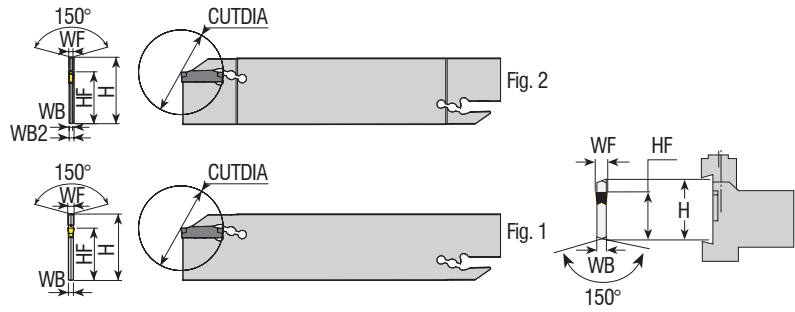

Takım Kodu Ordering Code Bestell-Bezeichnung	Stok Stock Lager	Takım Ölçüleri (mm) Dimension (mm) Abmessung (mm)								Kesici Uç Insert Wendeschneidplatte	Yedek Parçaları / Spare Parts Ersatzteile	
		H	WF	WB2	WB	I	HF	CUTDIA	Fig.		Anahtar Allen Key Innensechskantschlüssel	
AKL-K-32-2	●	32	2	2.40	1.60	150	25	32	2	MGM.-2	ALA-02	
AKL-K-32-3	●	32	3	-	2.40	150	25	42	1	MGM.-3		
AKL-K-32-4	●	32	4	-	3.20	150	25	42	1	MGM.-4		

Blok bilgileri için sayfa 155'ye gidin. / For block information, go to page 155. / Informationen zu den spannblock finden Sie auf Seite 155.

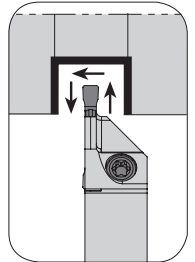
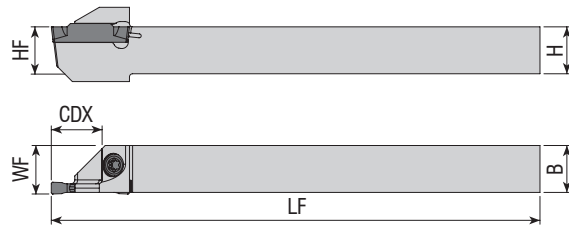

Takım Kodu Ordering Code Bestell-Bezeichnung	Stok Stock Lager		Takım Ölçüleri (mm) Dimension (mm) Abmessung (mm)					Kesici Uç Insert Wendeschneidplatte	Yedek Parçaları / Spare Parts / Ersatzteile			
	R	L	HF=H	B	LF	WF	CDX		Sıkma Vidası Screw Klemmschraube	Pul Stamp Ring	Tork Anahtar Torx Key Torx Innensechskantschlüssel	
ADKT-KG-R/L-1010-2-R10-K-S	●	○	10	10	125	10.2	10	KG. - 2	AKV-02-M6x22	ABPL-01	AAL-03-3	
ADKT-KG-R/L-1212-2-R12-K-S	●	●	12	12	125	12.2	12				80-T15	
ADKT-KG-R/L-1616-2-R16-K-S	●	●	16	16	125	16.2	16		KG. - 3	4015-M4x11	-	
ADKT-KG-R/L-1212-3-R12-K-S	●	●	12	12	125	12.3	12					
ADKT-KG-R/L-1616-3-R16-K-S	●	●	16	16	125	16.3	16					

R: Sağ / Right / Rechts L: Sol / Left / Links

● Stokta / In Stock / Auf Lager ○ Stokta Yok / Non Stock Item / Kein Lagerartikel, Lieferzeit auf Anfrage

KRLY Ucuna Uygundur. / Compatible with KRLY Insert. / Kompatibel mit KRLY Wendeplatten.

Sipariş Örneği/Ordering Example/Bestellbeispiel

1 ad./pcs./stück AKL-K-32-2

KRLY Ucuna Uygundur. / Compatible with KRLY Insert. / Kompatibel mit KRLY Wendeplatten.

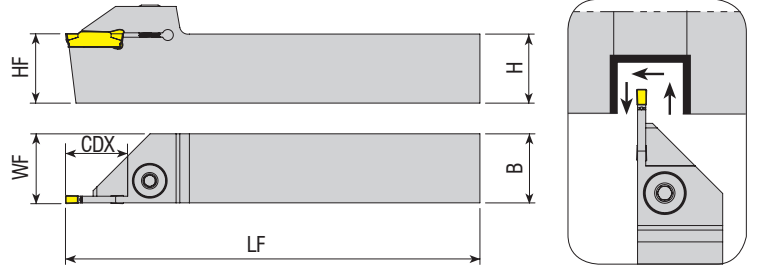

Takım Kodu Ordering Code Bestell-Bezeichnung	Stok Stock Lager		Takım Ölçüleri (mm) Dimension (mm) Abmessung (mm)				Kesici Uç Insert Wendeschneidplatte	Yedek Parçaları / Spare Parts / Ersatzteile			
	R	L	HF=H	B	LF	WF		CDX	Sıkma Vidası Screw Klemmschraube	Pul Stamp Ring	Anahtar Allen Key Innensechskantschlüssel
ADKT-KG-R/L-2020-2-T15	●	●	20	20	125	20.2	15	KG.. - 2	AKV-02-M6x22	ABPL-01	AAL-03-3
ADKT-KG-R/L-2525-2-T8	●	●	25	25	150	25.2	8				
ADKT-KG-R/L-2525-2-T15	●	○	25	25	150	25.2	15				
ADKT-KG-R/L-2525-2-T17	●	○	25	25	150	25.2	17	KG.. - 3	2004-M8x1x20	-	AAL-05-4
ADKT-KG-R/L-1616-3-T20	●	●	16	16	125	16.3	20				
ADKT-KG-R/L-2020-3-T20	●	●	20	20	125	20.3	20				
ADKT-KG-R/L-2525-3-T10	●	●	25	25	150	25.3	10				
ADKT-KG-R/L-2525-3-T13	●	●	25	25	150	25.3	13				
ADKT-KG-R/L-2525-3-T22	●	●	25	25	150	25.3	22				
ADKT-KG-R/L-2020-4-T20	●	●	20	20	125	20.4	20	KG.. - 4	2004-M8x1x20	-	AAL-05-4
ADKT-KG-R/L-2525-4-T10	●	●	25	25	150	25.4	10				
ADKT-KG-R/L-2525-4-T16	●	○	25	25	150	25.4	16				
ADKT-KG-R/L-2525-4-T22	●	○	25	25	150	25.4	22				
ADKT-KG-R/L-2525-5-T12	●	●	25	25	150	25.5	12	KG.. - 5	2004-M8x1x20	-	AAL-05-4
ADKT-KG-R/L-2525-5-T15	●	●	25	25	150	25.5	15				
ADKT-KG-R/L-2525-5-T25	●	○	25	25	150	25.5	25				
ADKT-KG-R/L-2525-6-T25	○	○	25	25	150	25.6	25	KG.. - 6	2004-M8x1x20	-	AAL-05-4

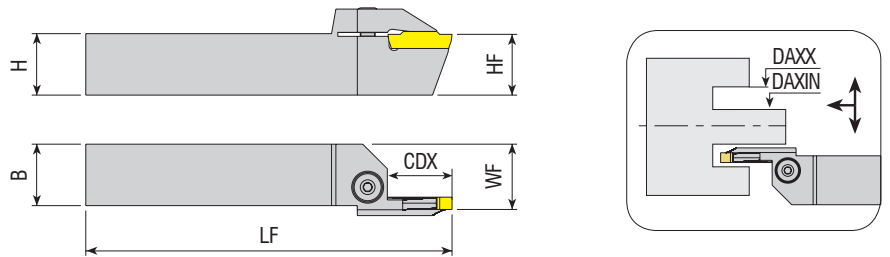

Takım Kodu Ordering Code Bestell-Bezeichnung	Stok Stock Lager		Takım Ölçüleri (mm) Dimension (mm) Abmessung (mm)							Kesici Uç Insert Wendeschneidplatte	Yedek Parçaları / Spare Parts / Ersatzteile			
	R	L	HF=H	B	LF	WF	CDX	DAXIN	DAXX		Sıkma Vidası Screw Klemmschraube	Pul Stamp Ring	Anahtar Allen Key Innensechskantschlüssel	
AAKT-KG-R/L-2525-44-70-4-T22	○	○	25	25	150	26.5	22	44	70	KG.. - 4	2004-M8x1x20	-	AAL-05-4	
AAKT-KG-R/L-2525-60-120-4-T22	○	○	25	25	150	26.5	22	60	120					
AAKT-KG-R/L-2525-112-200-4-T22	○	○	25	25	150	26.5	22	112	200					

R: Sağ / Right / Rechts L: Sol / Left / Links

● Stokta / In Stock / Auf Lager ○ Stokta Yok / Non Stock Item / Kein Lagerartikel, Lieferzeit auf Anfrage

KRLY Ucuna Uygundur. / Compatible with KRLY Insert. / Kompatibel mit KRLY Wendeplatten.

Sipariş Örneği/Ordering Example/Bestellbeispiel

1 ad./pcs./stück ADKT-KG-R-2020-2-T15

KRLY Ucuna Uygundur. / Compatible with KRLY Insert. / Kompatibel mit KRLY Wendeplatten.

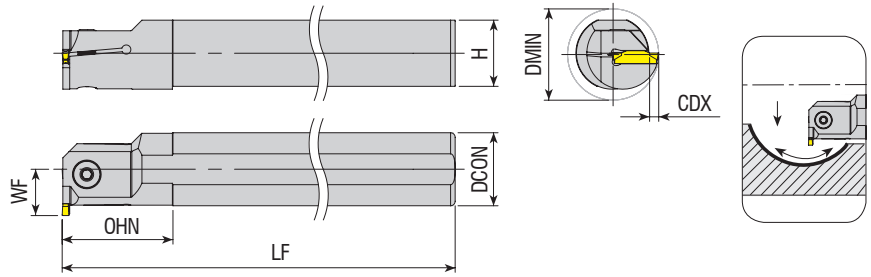

Takım Kodu Ordering Code Bestell-Bezeichnung	Stok Stock Lager		Takım Ölçüleri (mm) Dimension (mm) Abmessung (mm)							Kesici Uç Insert Wendeschneidplatte	Yedek Parçaları / Spare Parts / Ersatzteile	
	R	L	DCON	DMIN	LF	OHN	CDX	H	WF		Sıkma Vidası Screw Klemmschraube	Anahtar Allen Key Innensechskantschlüssel
AIKT-KG-R/L-25-2-T7	●	●	25	33	200	40	7	23	19.5	KG.. - 2	2504-M5x12	AAL-05-4
AIKT-KG-R/L-20-3-T6.5-H	●	○	20	27.5	170	30	6.5	18.3	16.5			
AIKT-KG-R/L-25-3-T7	○	○	25	33	200	40	7	23	19.5	KG.. - 3	2504-M5x16	
AIKT-KG-R/L-40-3-T8	●	○	40	50	300	55	8	37.5	28		2004-M8x1x20	
AIKT-KG-R/L-25-4-T8	●	●	25	34	200	40	8	23	20.5	KG.. - 4	2504-M5x16	

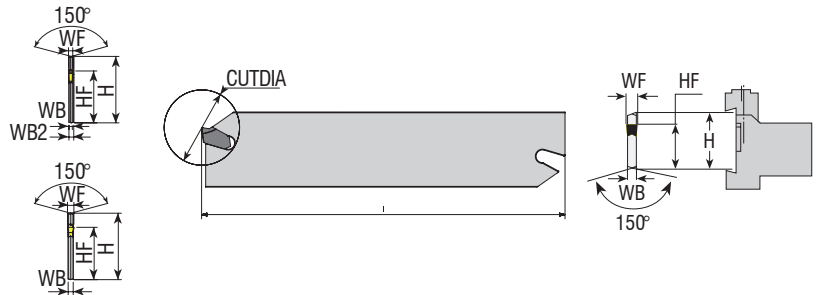

Takım Kodu Ordering Code Bestell-Bezeichnung	Stok Stock Lager	Takım Ölçüleri (mm) Dimension (mm) Abmessung (mm)								Kesici Uç Insert Wendeschneidplatte	Yedek Parçaları / Spare Parts / Ersatzteile	
		H	WF	WB2	WB	I	HF	CUTDIA	Fig.		Anahtar Allen Key Innensechskantschlüssel	
AKL-SP-26-2	●	26	2	-	1.60	110	21	-	1	SP200N	ALA-03	
AKL-SP-26-3	●	26	3	-	2.40	110	21	-	1			
AKL-SP-32-3	●	32	3	-	2.40	150	25	-	1	SP300N		
AKL-SP-32-4	●	32	4	-	3.20	150	25	-	1			SP400N

R: Sağ / Right / Rechts L: Sol / Left / Links

● Stokta / In Stock / Auf Lager ○ Stokta Yok / Non Stock Item / Kein Lagerartikel, Lieferzeit auf Anfrage

Block bilgileri için sayfa 155'ye gidin. / For block information, go to page 155. / Informationen zu den spannblock finden Sie auf Seite 155.

KRLY Ucuna Uygundur. / Compatible with KRLY Insert. / Kompatibel mit KRLY Wendeplatten.

Sipariş Örneği/Ordering Example/Bestellbeispiel

1 ad./pcs./stück AIKT-KG-R/L-25-2-T7

LMN Ucuna Uygundur. / Compatible with LMN Insert. / Kompatibel mit LMN Wendeplatten.

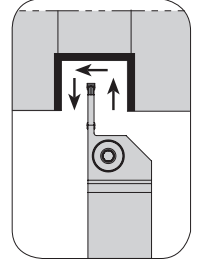
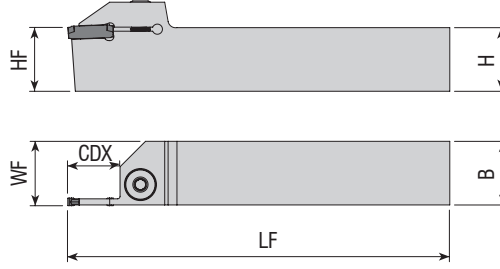

Takım Kodu
Ordering Code
Bestell-Bezeichnung

Stok
Stock
Lager

R L

HF=H

B

LF

WF

CDX

Kesici Uç
Insert
Wendeschneidplatte

Yedek Parçaları / Spare Parts / Ersatzteile

Sıkma Vidası
Screw
Klemmschraube

Pul
Stamp
Ring

Anahtar
Allen Key
Innensechskantschlüssel

ADKT-LGC-R/L-1616-2-D40
ADKT-LGC-R/L-2020-2-D40
ADKT-LGC-R/L-2525-2-D40
ADKT-LGC-R/L-1616-3-T20
ADKT-LGC-R/L-2020-3-T20
ADKT-LGC-R/L-2525-3-T20

● ●
● ●
● ●
● ●
● ●
● ●

16
20
25
16
20
25

16
20
25
16
20
25

125
125
150
125
125
150

16.2
20.2
25.2
16.3
20.3
25.3

20
20
20
20
20
20

GCTX - 2
GCTX - 3

AKV-02-M6x22
2004-M8x1x20

ABPL-01
-

AAL-03-3
AAL-05-4

LMN Ucuna Uygundur. / Compatible with LMN Insert. / Kompatibel mit LMN Wendeplatten.

MTSBH Ucuna Uygundur. / Compatible with MTSBH Insert. / Kompatibel mit MTSBH Wendeplatten.

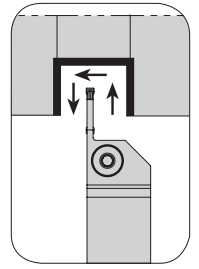
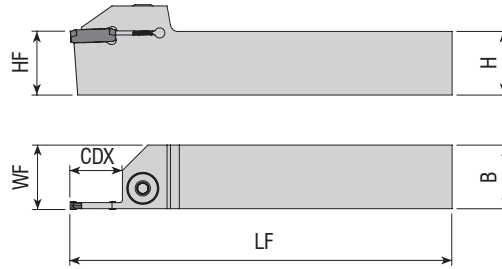

Takım Kodu
Ordering Code
Bestell-Bezeichnung

Stok
Stock
Lager

R L

HF=H

B

LF

WF

CDX

Kesici Uç
Insert
Wendeschneidplatte

Yedek Parçaları / Spare Parts / Ersatzteile

Sıkma Vidası
Screw
Klemmschraube

Pul
Stamp
Ring

Anahtar
Allen Key
Innensechskantschlüssel

ADKT-GY2-R/L-2525-2-R20
ADKT-GY2-R/L-2525-2.5-R6
ADKT-GY2-R/L-2525-3-R20
ADKT-GY2-R/L-2525-4-T25
ADKT-GY2-R/L-2525-5-T25

● ○
● ○
● ○
● ○
● ○

25
25
25
25
25

25
25
25
25
25

150
150
150
150
150

25.2
25.25
25.3
25.4
25.5

20
6
20
25
25

GY2M-0200
GY2M-0250
GY2M-0300
GY2M-0400
GY2M-0500

AKV-02-M6X22
2004-M8x1x20

ABPL-01
-

AAL-03-3
AAL-05-4

R: Sağ / Right / Rechts L: Sol / Left / Links

● Stokta / In Stock / Auf Lager ○ Stokta Yok / Non Stock Item / Kein Lagerartikel, Lieferzeit auf Anfrage

MTSBH Ucuna Uygundur. / Compatible with MTSBH Insert. / Kompatibel mit MTSBH Wendeplatten.

Sipariş Örneği/Ordering Example/Bestellbeispiel

1 ad./pcs./stück ADKT-LGC-R-1616-2-D40



MTSBH Ucuna Uygundur. / Compatible with MTSBH Insert. / Kompatibel mit MTSBH Wendeplatten.

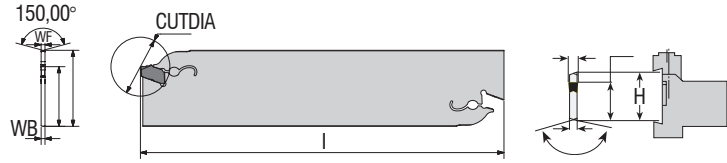

Takım Kodu Ordering Code Bestell-Bezeichnung	Stok Stock Lager		Takım Ölçüleri (mm) Dimension (mm) Abmessung (mm)							Kesici Uç Insert Wendeschneidplatte	Yedek Parçaları / Spare Parts Ersatzteile	
	R	L	H	WF	WB2	WB	I	HF	CUTDIA		Fig.	Anahtar Allen Key Innensechskantschlüssel
AKL-GW1-32-2	●		32	2	1.6	-	150	25	60	1	GW1M0200D020N	ALA-02
AKL-GW1-32-3	●		32	3	2.4	-	150	25	60	1	GW1M0300F030N	
AKL-GW1-32-4	●		32	4	3.35	-	150	25	60	1	GW1M0400H030N	

Blok bilgileri için sayfa 155'ye gidin. / For block information, go to page 155. / Informationen zu den spannblock finden Sie auf Seite 155.

MTSBH Ucuna Uygundur. / Compatible with MTSBH Insert. / Kompatibel mit MTSBH Wendeplatten.

NTK Ucuna Uygundur. / Compatible with NTK Insert. / Kompatibel mit NTK Wendeplatten.

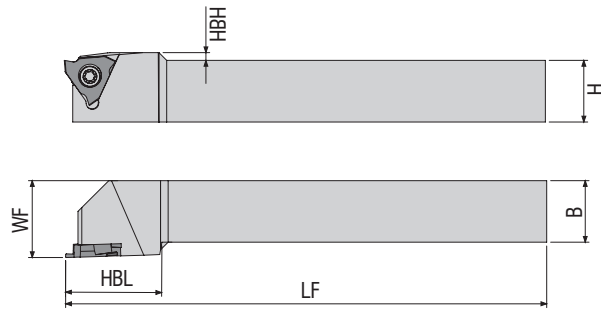
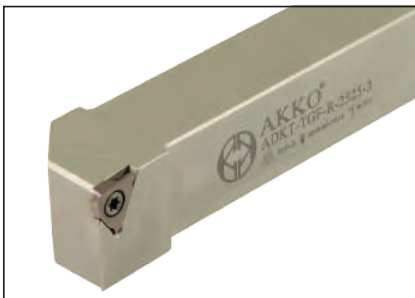

Takım Kodu Ordering Code Bestell-Bezeichnung	Stok Stock Lager		Takım Ölçüleri (mm) Dimension (mm) Abmessung (mm)				Kesici Uç Insert Wendeschneidplatte	Yedek Parçaları / Spare Parts / Ersatzteile			
	R	L	HF=H	B	LF	WF		Sıkma Vidası Screw Klemmschraube	Pul Stamp Ring	Tork Anahtar Torx Key Torx Innensechskantschlüssel	
ADKT-TGF-R/L-1616-3	●	○	16	16	125	20	QC16L150	4015-M3.5X10	-	80-T15	
ADKT-TGF-R/L-2020-3	●	○	20	20	125	25					
ADKT-TGF-R/L-2525-3	●	○	25	25	150	32					

R: Sağ / Right / Rechts L: Sol / Left / Links

● Stokta / In Stock / Auf Lager ○ Stokta Yok / Non Stock Item / Kein Lagerartikel, Lieferzeit auf Anfrage

NTK Ucuna Uygundur. / Compatible with NTK Insert. / Kompatibel mit NTK Wendeplatten.

Sipariş Örneği/Ordering Example/Bestellbeispiel

1 ad./pcs./stück AKL-GW1-32-2

PLBT Ucuna Uygundur. / Compatible with PLBT Insert. / Kompatibel mit PLBT Wendeplatten.

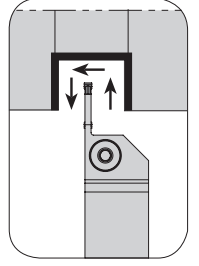
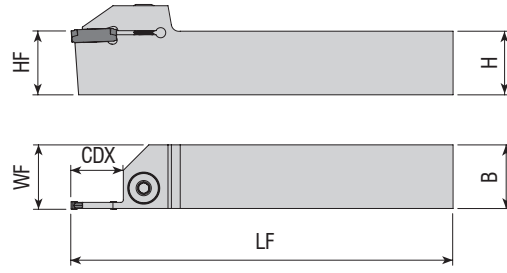

Takım Kodu Ordering Code Bestell-Bezeichnung	Stok Stock Lager		Takım Ölçüleri (mm) Dimension (mm) Abmessung (mm)				Kesici Uç Insert Wendeschneidplatte	Yedek Parçaları / Spare Parts / Ersatzteile			
	R	L	HF=H	B	LF	WF		CDX	Sıkma Vidası Screw Klemmschraube	Pul Stamp Ring	Anahtar Allen Key Innensechskantschlüssel
ADKT-GP-R/L-2020-2-T15	●	●	20	20	125	20.2	15	GP - 2	AKV-02-M6x22	ABPL-01	AAL-03-3
ADKT-GP-R/L-2525-2-T15	●	●	25	25	150	25.2	15				
ADKT-GP-R/L-2020-3-T20	●	●	20	20	125	20.3	20	GP - 3	2004-M8x1x20	-	AAL-05-4
ADKT-GP-R/L-2525-3-T22	●	●	25	25	150	25.3	22				
ADKT-GP-R/L-2525-4-T22	●	●	25	25	150	25.4	22	GP - 4	-	-	-
ADKT-GP-R/L-2525-5-T25	●	●	25	25	150	25.5	25				

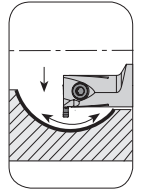
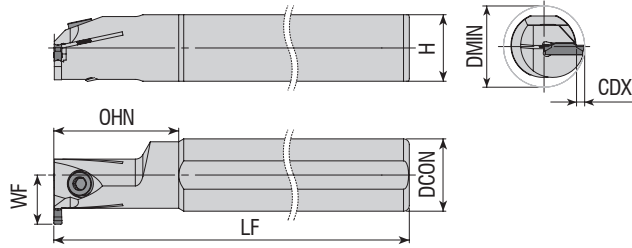

Takım Kodu Ordering Code Bestell-Bezeichnung	Stok Stock Lager		Takım Ölçüleri (mm) Dimension (mm) Abmessung (mm)						Kesici Uç Insert Wendeschneidplatte	Yedek Parçaları / Spare Parts / Ersatzteile		
	R	L	DCON	DMIN	LF	OHN	CDX	H		WF	Sıkma Vidası Screw Klemmschraube	Anahtar Allen Key Innensechskantschlüssel
AIKT-GP-R/L-20-2-T4	●	○	20	25	170	30	4	18.3	14.5	GP - 2	2503-M4x12	AAL-03-3
AIKT-GP-R/L-25-2-T6	●	○	25	32	200	40	6	23	18.5			
AIKT-GP-R/L-20-3-T6	●	○	20	27	170	30	6	18.3	16	GP - 3	2504-M5X16	AAL-05-4
AIKT-GP-R/L-25-3-T6	●	○	25	32	200	40	6	23	18.5			
AIKT-GP-R/L-32-3-T6	●	○	32	39	250	50	6	30	22	GP - 4	2004-M8x1x20	-
AIKT-GP-R/L-20-4-T6	●	○	20	27	170	30	6	18.3	16			
AIKT-GP-R/L-25-4-T6	●	○	25	32	200	40	6	23	18.5	-	-	-
AIKT-GP-R/L-32-4-T6	●	○	32	39	250	50	6	30	22			

R: Sağ / Right / Rechts L: Sol / Left / Links

● Stokta / In Stock / Auf Lager ○ Stokta Yok / Non Stock Item / Kein Lagerartikel, Lieferzeit auf Anfrage

PLBT Ucuna Uygundur. / Compatible with PLBT Insert. / Kompatibel mit PLBT Wendeplatten.

Sipariş Örneği/Ordering Example/Bestellbeispiel
1 ad./pcs./stück ADKT-GP-R-2020-2-T15

SC Ucuna Uygundur. / Compatible with SC Insert. / Kompatibel mit SC Wendeplatten.

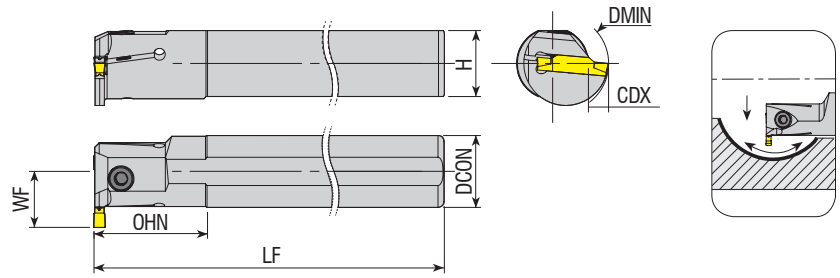

Takım Kodu Ordering Code Bestell-Bezeichnung	Stok Stock Lager		Takım Ölçüleri (mm) Dimension (mm) Abmessung (mm)							Kesici Uç Insert Wendeschneidplatte	Yedek Parçaları / Spare Parts / Ersatzteile	
	R	L	DCON	DMIN	LF	OHN	CDX	H	WF		Sıkma Vidası Screw Klemmschraube	Anahtar Allen Key Innensechskantschlüssel
AIKT-LC13-R-16-3-T4	●	○	16	20	150	28	4	14.8	12	LC.. 130404-0300 LC.. 130404-0400	2503-M4x10	AAL-03-3
AIKT-LC13-R-16-4-T6	●	○	16	22	150	28	6	14.8	14			

SC Ucuna Uygundur. / Compatible with SC Insert. / Kompatibel mit SC Wendeplatten.

SMTM Ucuna Uygundur. / Compatible with SMTM Insert. / Kompatibel mit SMTM Wendeplatten.

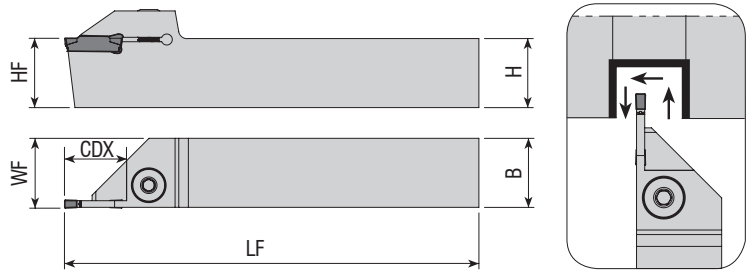

Takım Kodu Ordering Code Bestell-Bezeichnung	Stok Stock Lager		Takım Ölçüleri (mm) Dimension (mm) Abmessung (mm)					Kesici Uç Insert Wendeschneidplatte	Yedek Parçaları / Spare Parts / Ersatzteile		
	R	L	HF=H	B	LF	WF	CDX		Sıkma Vidası Screw Klemmschraube	Pul Stamp Ring	Anahtar Allen Key Innensechskantschlüssel
ADKT-SGC-R/L-1212-2-R15	●	●	12	12	100	16.2	15	GCM N20	AKV-02-M6x22	ABPL-01	AAL-03-3
ADKT-SGC-R/L-1616-2-R15	●	●	16	16	125	16.2	15				
ADKT-SGC-R/L-2020-2-R20	●	●	20	20	125	20.2	20				
ADKT-SGC-R/L-2525-2-R20	●	●	25	25	150	25.2	20	GCM N30	2004-M8x1x20	-	AAL-05-4
ADKT-SGC-R/L-1212-3-R15	●	●	12	12	100	16.3	15				
ADKT-SGC-R/L-1616-3-T12	●	○	16	16	125	16.3	12				
ADKT-SGC-R/L-1616-3-R15	●	●	16	16	125	16.3	15	GCM N40			
ADKT-SGC-R/L-2020-3-R22	●	●	20	20	125	20.3	22				
ADKT-SGC-R/L-2525-3-T10	○	●	25	25	150	25.30	10				
ADKT-SGC-R/L-2525-3-R15	●	○	25	25	150	25.3	15	GCM N40			
ADKT-SGC-R/L-2525-3-R22	●	●	25	25	150	25.3	22				
ADKT-SGC-R/L-2525-4-T10	○	●	25	25	150	25.40	10				
ADKT-SGC-R/L-2525-4-T15	○	●	25	25	150	25.40	15	GCM N40			
ADKT-SGC-R/L-2525-4-T20	○	●	25	25	150	25.40	20				
ADKT-SGC-R/L-2525-4-R25	●	○	25	25	150	25.4	25				

R: Sağ / Right / Rechts L: Sol / Left / Links

● Stokta / In Stock / Auf Lager ○ Stokta Yok / Non Stock Item / Kein Lagerartikel, Lieferzeit auf Anfrage

SMTM Ucuna Uygundur. / Compatible with SMTM Insert. / Kompatibel mit SMTM Wendeplatten.

Sipariş Örneği/Ordering Example/Bestellbeispiel

1 ad./pcs./stück AIKT-LC13-R-16-3-T4

SMTM Ucuna Uygun. / Compatible with SMTM Insert. / Kompatibel mit SMTM Wendeplatten.

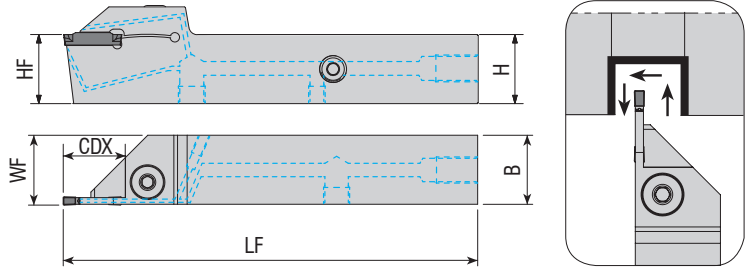

Takım Kodu
Ordering Code
Bestell-Bezeichnung

Stok
Stock
Lager

Takım Ölçüleri (mm)
Dimension (mm)
Abmessung (mm)

Kesici Uç
Insert
Wendeschneidplatte

Yedek Parçaları / Spare Parts / Ersatzteile

Sıkma Vidası
Screw
Klemmschraube

Pul
Stamp
Ring

Anahtar
Allen Key
Innensechskantschlüssel

R

L

HF=H

B

LF

WF

CDX



ADKT-SGC-R/L-2525-3-R25-H

○

●

25

25

150

25.3

25

GCM N30

2004-M8x1x20

-

AAL-05-4

R: Sağ / Right / Rechts L: Sol / Left / Links

● Stokta / In Stock / Auf Lager ○ Stokta Yok / Non Stock Item / Kein Lagerartikel, Lieferzeit auf Anfrage

SMTM Ucuna Uygun. / Compatible with SMTM Insert. / Kompatibel mit SMTM Wendeplatten.

Sipariş Örneği/Ordering Example/Bestellbeispiel

1 ad./pcs./stück ADKT-SGC-R-2525-3-R25-H



SMTM Ucuna Uygundur. / Compatible with SMTM Insert. / Kompatibel mit SMTM Wendeplatten.

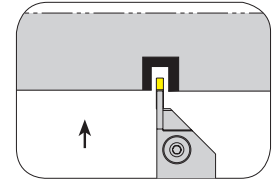
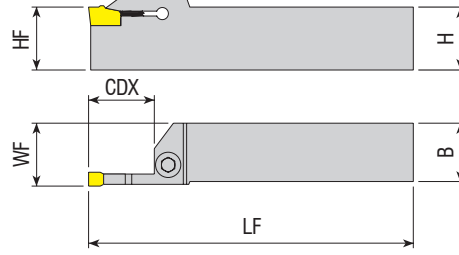

Takım Kodu Ordering Code Bestell-Bezeichnung	Stok Stock Lager		Takım Ölçüleri (mm) Dimension (mm) Abmessung (mm)					Kesici Uç Insert Wendeschneidplatte	Yedek Parçaları / Spare Parts / Ersatzteile		
	R	L	HF=H	B	LF	WF	CDX		Sıkma Vidası Screw Klemmschraube	Pul Stamp Ring	Anahtar Allen Key Innensechskantschlüssel
ADKT-SWC-R/L-2020-2-T25	●	○	20	20	125	20.3	25	WCF - 2	AKV-02-M6x22	ABPL-01	AAL-03-3
ADKT-SWC-R/L-2020-3-T25	●	○	20	20	125	20.4	25	WCF - 3	2004-M8x1x20	-	AAL-05-4

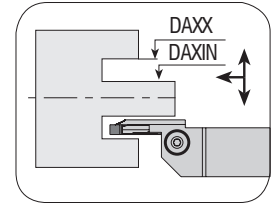
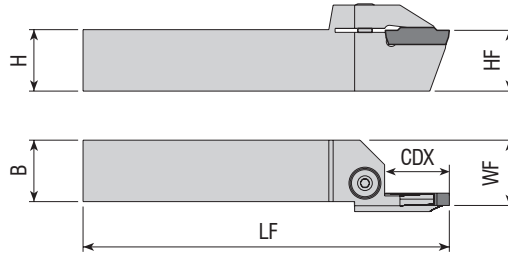

Takım Kodu Ordering Code Bestell-Bezeichnung	Stok Stock Lager		Takım Ölçüleri (mm) Dimension (mm) Abmessung (mm)							Kesici Uç Insert Wendeschneidplatte	Yedek Parçaları / Spare Parts / Ersatzteile		
	R	L	HF=H	B	LF	WF	CDX	DAXIN	DAXX		Sıkma Vidası Screw Klemmschraube	Pul Stamp Ring	Anahtar Allen Key Innensechskantschlüssel
AAKT-SGC-R/L-2020-22-53-3-T13	○	●	20	20	125	21.5	13	22	53	GCM N3002	2004-M8X1X20	-	AAL-05-4
AAKT-SGC-R/L-2525-80-100-3-T8	●	○	25	25	150	26.5	8	80	100				
AAKT-SGC-R/L-2525-40-65-4-T12	●	○	25	25	150	26.5	12	40	65	GCM N4020	2004-M8X1X20	-	AAL-05-4
AAKT-SGC-R/L-2525-80-140-4-T8	●	○	25	25	150	26.5	8	80	140				

R: Sağ / Right / Rechts L: Sol / Left / Links

● Stokta / In Stock / Auf Lager ○ Stokta Yok / Non Stock Item / Kein Lagerartikel, Lieferzeit auf Anfrage

SMTM Ucuna Uygundur. / Compatible with SMTM Insert. / Kompatibel mit SMTM Wendeplatten.

Sipariş Örneği/Ordering Example/Bestellbeispiel

1 ad./pcs./stück ADKT-SWC-R-2020-2-T25

SMTM Ucuna Uygundur. / Compatible with SMTM Insert. / Kompatibel mit SMTM Wendeplatten.

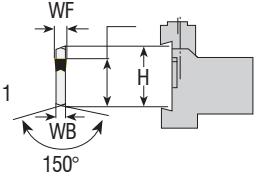
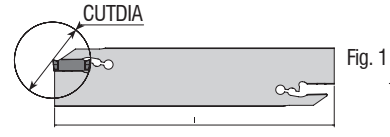
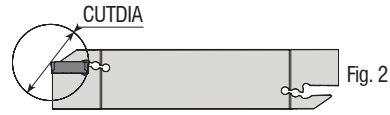
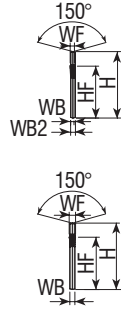

Takım Kodu Ordering Code Bestell-Bezeichnung	Stok Stock Lager	Takım Ölçüleri (mm) Dimension (mm) Abmessung (mm)								Kesici Uç Insert Wendeschneidplatte	Yedek Parçaları / Spare Parts Ersatzteile	
		H	WF	WB2	WB	I	HF	CUTDIA	Fig.		Anahtar Allen Key Innensechskantschlüssel	
AKL-SGC-26-3	●	26	3	2.40	-	110	21.4	39	2	GCM N30	ALA-02	
AKL-SGC-32-3	●	32	3	2.40	-	150	25	39	1			

Blok bilgileri için sayfa 155'ye gidin. / For block information, go to page 155. / Informationen zu den spannblock finden Sie auf Seite 155.

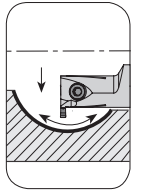
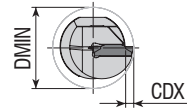
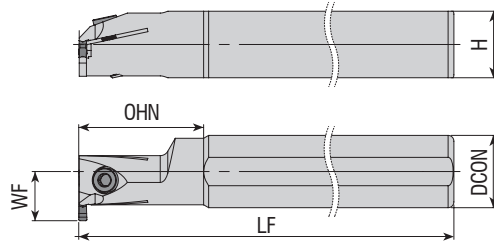

Takım Kodu Ordering Code Bestell-Bezeichnung	Stok Stock Lager		Takım Ölçüleri (mm) Dimension (mm) Abmessung (mm)							Kesici Uç Insert Wendeschneidplatte	Yedek Parçaları / Spare Parts / Ersatzteile	
	R	L	DCON	DMIN	LF	OHN	CDX	H	WF		Sıkma Vidası Screw Klemmschraube	Anahtar Allen Key Innensechskantschlüssel
AIKT-SGC-R/L-25-3-T6	●	○	25	32	200	40	6	23	18.5	GCM N30	2504-M5x16	AAL-05-4
AIKT-SGC-R/L-32-3-T6	●	○	32	39	250	50	6	30	22			
new AIKT-SGC-R/L-32-3-T12	●	●	32	45	250	50	12	30	28			
AIKT-SGC-R/L-40-3-T6	●	○	40	47	300	55	6	37.5	26			
new AIKT-SGC-R/L-40-3-T12	●	●	40	53	300	55	12	37.5	12	GCM N40	2004-M8x1x20	AAL-05-4
new AIKT-SGC-R/L-25-4-T6	●	●	25	32	200	40	6	23	18.5			
new AIKT-SGC-R/L-25-4-T12	●	●	25	38	200	40	12	23	24.5			
new AIKT-SGC-R/L-32-4-T6	●	●	32	39	250	50	6	30	22			
new AIKT-SGC-R/L-32-4-T12	●	●	32	45	250	50	12	30	28			
new AIKT-SGC-R/L-40-4-T6	●	●	40	47	300	55	6	37.5	26			
new AIKT-SGC-R/L-40-4-T12	●	●	40	53	300	55	12	37.5	32			

R: Sağ / Right / Rechts L: Sol / Left / Links

● Stokta / In Stock / Auf Lager ○ Stokta Yok / Non Stock Item / Kein Lagerartikel, Lieferzeit auf Anfrage

SMTM Ucuna Uygundur. / Compatible with SMTM Insert. / Kompatibel mit SMTM Wendeplatten.

Sipariş Örneği/Ordering Example/Bestellbeispiel

1 ad./pcs./stück AKL-SGC-26-3

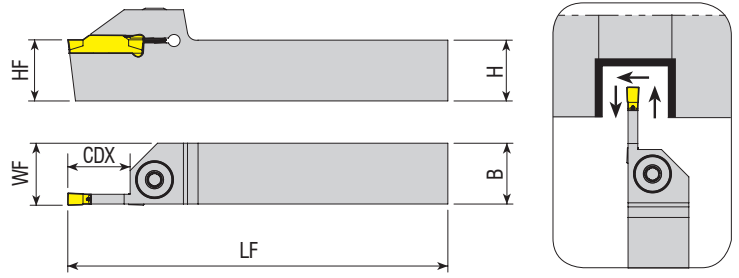

Takım Kodu Ordering Code Bestell-Bezeichnung	Stok Stock Lager		Takım Ölçüleri (mm) Dimension (mm) Abmessung (mm)					Kesici Uç Insert Wendeschneidplatte	Yedek Parçaları / Spare Parts / Ersatzteile			
	R	L	HF=H	B	LF	WF	CDX		Sıkma Vidası Screw Klemmschraube	Pul Stamp Ring	Anahtar Allen Key Innensechskantschlüssel	
ADKT-123-R/L-1212-1.5-R15	●	●	12	12	100	12.2	15	123 - 1.5				
ADKT-123-R/L-1616-1.5-R15	●	●	16	16	125	16.2	15					
ADKT-123-R/L-2012-1.5-R15	○	●	20	12	125	12.5	15					
new ADKT-123-R/L-1212-2-T12	○	●	12	12	125	12.2	12	123 - 2	4015-M4x11	-	80-T15	
ADKT-123-R/L-1616-2-T15	●	○	16	16	125	16.2	15		AKV-02-M6x22	ABPL-01	AAL-03-3	
ADKT-123-R/L-2020-2-T8	●	●	20	20	125	20.2	8					
ADKT-123-R/L-2020-2-T15	●	●	20	20	125	20.2	15					
ADKT-123-R/L-2525-2-T8	●	●	25	25	150	25.2	8					
ADKT-123-R/L-2525-2-T15	●	●	25	25	150	25.2	15					
ADKT-123-R/L-3232-2-T15	●	●	32	32	170	32.2	15					
new ADKT-123-R/L-1616-2.5-R17	○	●	16	16	125	16.25	17		123 - 2.5	2004-M8x1x20		AAL-05-4
ADKT-123-R/L-1616-3-T10	●	●	16	16	125	16.3	10	123 - 3	2004-M8x1x20	-	AAL-05-4	
ADKT-123-R/L-1616-3-T15	●	●	16	16	125	16.3	15					
ADKT-123-R/L-2020-3-T10	●	●	20	20	125	20.3	10					
ADKT-123-R/L-2020-3-T15	●	●	20	20	125	20.3	15					
ADKT-123-R/L-2020-3-T20	●	●	20	20	125	20.3	20					
ADKT-123-R/L-2525-3-T10	●	●	25	25	150	25.3	10					
ADKT-123-R/L-2525-3-T15	●	●	25	25	150	25.3	15					
ADKT-123-R/L-2525-3-T22	●	●	25	25	150	25.3	22					
ADKT-123-R/L-2020-4-T20	●	●	20	20	125	20.4	20	123 - 4				
ADKT-123-R/L-2525-4-T13	●	●	25	25	150	25.4	13					
ADKT-123-R/L-2525-4-T22	●	●	25	25	150	25.4	22					
ADKT-123-R/L-3232-4-T25	●	●	32	32	170	32.4	25					
ADKT-123-R/L-2020-5-T20	●	●	20	20	125	20.5	20	123 - 5				
ADKT-123-R/L-2525-5-T25	●	●	25	25	150	25.5	25	123 - 6				
ADKT-123-R/L-3232-6-T15	●	●	32	32	170	32.5	15					

R: Sağ / Right / Rechts L: Sol / Left / Links

● Stokta / In Stock / Auf Lager ○ Stokta Yok / Non Stock Item / Kein Lagerartikel, Lieferzeit auf Anfrage

SNDVK Ucuna Uygunur. / Compatible with SNDVK Insert. / Kompatibel mit SNDVK Wendeplatten.

Sipariş Örneği/Ordering Example/Bestellbeispiel

1 ad./pcs./stück ADKT-123-R-1212-1.5-R15

SNDVK Ucuna Uygun. / Compatible with SNDVK Insert. / Kompatibel mit SNDVK Wendeplatten.

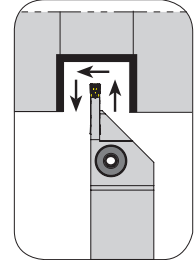
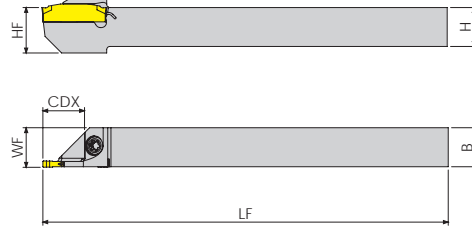

Takım Kodu Ordering Code Bestell-Bezeichnung	Stok Stock Lager		Takım Ölçüleri (mm) Dimension (mm) Abmessung (mm)					Kesici Uç Insert Wendeschneidplatte	Yedek Parçaları / Spare Parts / Ersatzteile		
	R	L	HF=H	B	LF	WF	CDX		Sıkma Vidası Screw Klemmschraube	Pul Stamp Ring	Tork Anahtar Torx Key Torx Innensechskantschlüssel
ADKT-123-R/L-1212-2-T12-K-S	●	○	12	12	125	12.2	12				
ADKT-123-R/L-1212-3-T12-K-S	○	○	12	12	125	12.3	12		4015-M4X11	-	80-T15

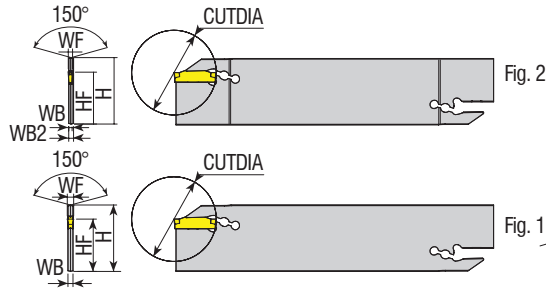

Takım Kodu Ordering Code Bestell-Bezeichnung	Stok Stock Lager	Takım Ölçüleri (mm) Dimension (mm) Abmessung (mm)								Kesici Uç Insert Wendeschneidplatte	Fig.
		H	WF	WB2	WB	I	HF	CUTDIA	Fig.		
AKL-123-32-2	●	32	2	2.4	1.6	150	25	39	2		
AKL-123-32-3	●	32	3	2.4	-	150	25	39	1		
AKL-123-32-4	●	32	4	3.2	-	150	25	39	1		
new AKL-123-32-6	●	32	6	5	-	150	25	55	1		

R: Sağ / Right / Rechts L: Sol / Left / Links

● Stokta / In Stock / Auf Lager ○ Stokta Yok / Non Stock Item / Kein Lagerartikel, Lieferzeit auf Anfrage

Blok bilgileri için sayfa 155'ye gidin. / For block information, go to page 155. / Informationen zu den spannblock finden Sie auf Seite 155.

SNDVK Ucuna Uygun. / Compatible with SNDVK Insert. / Kompatibel mit SNDVK Wendeplatten.

Sipariş Örneği/Ordering Example/Bestellbeispiel

1 ad./pcs./stück ADKT-123-R-1212-2-T12-K-S

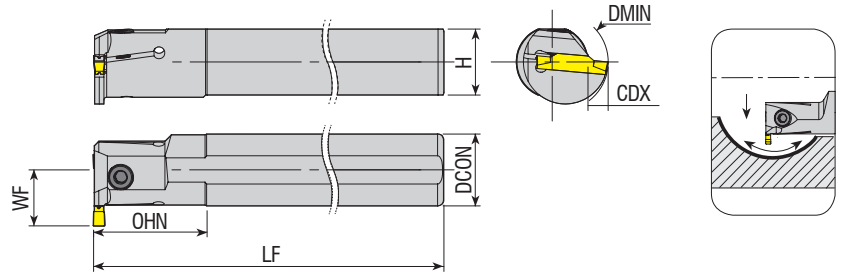

Takım Kodu Ordering Code Bestell-Bezeichnung	Stok Stock Lager		Takım Ölçüleri (mm) Dimension (mm) Abmessung (mm)							Kesici Uç Insert Wendeschneidplatte	Yedek Parçaları / Spare Parts / Ersatzteile		
	R	L	DCON	DMIN	LF	OHN	CDX	H	WF		Sıkma Vidası Screw Klemmschraube	Anahtar Allen Key Innensechskantschlüssel	
AIKT-123-R/L-20-2-T6	●	○	20	32	170	30	6	18.3	16	123 - 2	2503-M4x12	AAL-03-3	
AIKT-123-R/L-25-2-T6	●	○	25	32	200	40	6	18.3	18.5		2504-M5x12	AAL-05-4	
AIKT-123-R/L-32-2-T7	●	○	32	41	250	45	7	30	23	2004-M8x1x20			
AIKT-123-R/L-20-3-T6	●	○	20	32	170	30	6	18.3	16	123 - 3	2504-M5x16	AAL-05-4	
AIKT-123-R/L-25-3-T7	●	○	25	32	200	40	7	23	19.5		2004-M8x1x20		
AIKT-123-R/L-32-3-T9	●	○	32	41	250	50	9	30	25	2504-M5x16	AAL-05-4		
AIKT-123-R/L-20-4-T8	●	○	20	29	170	30	8	18.3	18	2004-M8x1x20			
AIKT-123-R/L-25-4-T7	●	○	25	32	200	40	7	23	19.5	123 - 4	2504-M5x16	AAL-05-4	
AIKT-123-R/L-32-4-T7	●	●	32	41	250	45	7	30	23		2004-M8x1x20		
AIKT-123-R/L-32-4-T10	●	○	32	43	250	50	10	30	26	123 - 5	2504-M5x16	AAL-05-4	
AIKT-123-R/L-25-5-T8	●	○	25	34	200	40	8	23	20.5		2004-M8x1x20		
AIKT-123-R/L-32-5-T11	●	●	32	43	250	50	11	30	27	2504-M5x16	2004-M8x1x20		

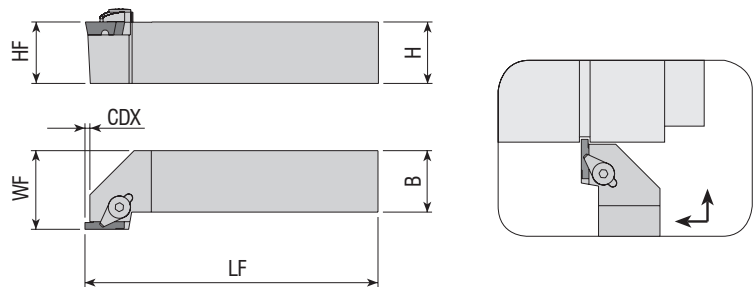

Takım Kodu Ordering Code Bestell-Bezeichnung	Stok Stock Lager		Takım Ölçüleri (mm) Dimension (mm) Abmessung (mm)					Kesici Uç Insert Wendeschneidplatte	Yedek Parçaları / Spare Parts / Ersatzteile				
	R	L	HF=H	B	LF	WF	CDX		Baskı Parçası Wedge Clamp Spannspratze	Sıkma Vidası Screw Klemmschraube	Pul Stamp Ring	Anahtar Allen Key Innensechskantschlüssel	
ADKT-154.91-R/L-2020-3-T4	●	●	20	20	125	25	4	154.91 - 3	ACK-03	AKV-07-M6x22	APM-06	AAL-03-3	
ADKT-154.91-R/L 2525-3-T4	●	●	25	25	150	30.5	4						
ADKT-154.91-R/L 2020-5-T5	●	●	20	20	125	25	5	154.91 - 5	ACK-03	AKV-07-M6x22	APM-06	AAL-03-3	
ADKT-154.91-R/L 2525-5-T5	●	●	25	25	150	30.5	5						

R: Sağ / Right / Rechts L: Sol / Left / Links

● Stokta / In Stock / Auf Lager ○ Stokta Yok / Non Stock Item / Kein Lagerartikel, Lieferzeit auf Anfrage

SNDVK Ucuna Uygundur. / Compatible with SNDVK Insert. / Kompatibel mit SNDVK Wendeplatten.

Sipariş Örneği/Ordering Example/Bestellbeispiel

1 ad./pcs./stück AIKT-123-R-20-2-T6

SNDVK Ucuna Uygun. / Compatible with SNDVK Insert. / Kompatibel mit SNDVK Wendeplatten.

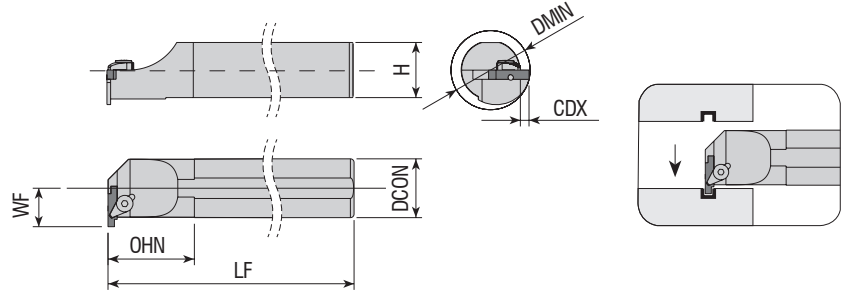

Takım Kodu Ordering Code Bestell-Bezeichnung	Stok Stock Lager		Takım Ölçüleri (mm) Dimension (mm) Abmessung (mm)							Kesici Uç Insert Wendeschneidplatte	Yedek Parçaları / Spare Parts / Ersatzteile			
	R	L	DCON	DMIN	LF	OHN	CDX	H	WF		Baskı Parçası Wedge Clamp Spannpratze	Sıkma Vidası Screw Klemmschraube	Pim Pin Stift	Anahtar Allen Key Innensechskantschlüssel
AIKT-154.91-R/L-16-3-T3	●	●	16	20	150	35	3	14.8	11	154.91 - 3	ACK-06	AKV-10-M6x14	APM-06	AAL-05-4
AIKT-154.91-R/L-20-3-T4	●	●	20	25	170	38	4	18.3	14					
AIKT-154.91-R/L-25-3-T4	●	●	25	31	200	40	4	23	16.5	154.91 - 5	ACK-03	AKV-21-M6x18 AKV-07-M6x22	AAL-03-3	
AIKT-154.91-R/L-25-5-T5	●	●	25	31	200	45	5	23	17.5					
AIKT-154.91-R/L-32-5-T5	●	●	32	38	250	50	5	30	21					

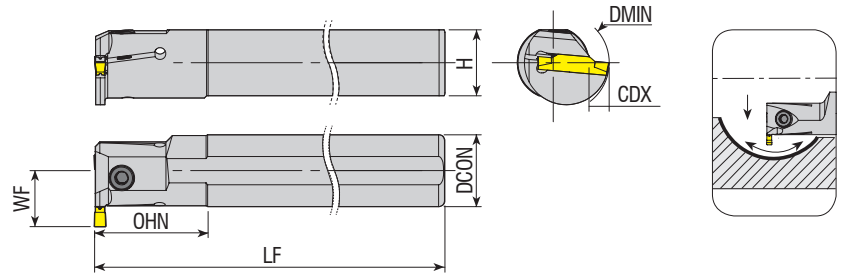

Takım Kodu Ordering Code Bestell-Bezeichnung	Stok Stock Lager		Takım Ölçüleri (mm) Dimension (mm) Abmessung (mm)							Kesici Uç Insert Wendeschneidplatte	Yedek Parçaları / Spare Parts / Ersatzteile	
	R	L	DCON	DMIN	LF	OHN	CDX	H	WF		Sıkma Vidası Screw Klemmschraube	Anahtar Allen Key Innensechskantschlüssel
AIKT-151.23-R/L-20-2-T6	●	○	20	32	170	30	6	18.3	16	151.23 - 2	2503-M4x12	AAL-03-3
AIKT-151.23-R/L-20-2.5-T6	●	○	20	32	170	30	6	18.3	16			
AIKT-151.22-R/L-25-3-T6	○	●	25	37	200	32	6	23	18.5	151.23 - 3		
AIKT-151.22-R/L-25-3-T6-H	○	●	25	37	200	32	6	23	18.5			

R: Sağ / Right / Rechts L: Sol / Left / Links

● Stokta / In Stock / Auf Lager ○ Stokta Yok / Non Stock Item / Kein Lagerartikel, Lieferzeit auf Anfrage

SNDVK Ucuna Uygun. / Compatible with SNDVK Insert. / Kompatibel mit SNDVK Wendeplatten.

Sipariş Örneği/Ordering Example/Bestellbeispiel

1 ad./pcs./stück AIKT-154.91-R/L-16-3-T3

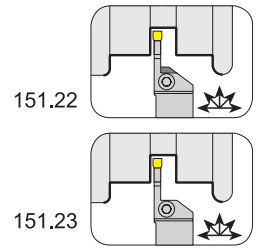
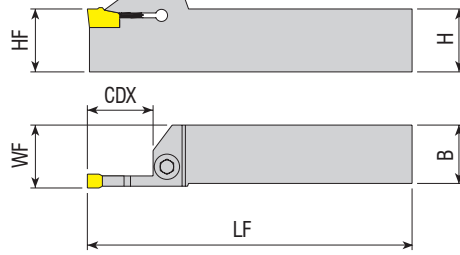

Takım Kodu Ordering Code Bestell-Bezeichnung	Stok Stock Lager		Takım Ölçüleri (mm) Dimension (mm) Abmessung (mm)				Kesici Uç Insert Wendeschneidplatte	Yedek Parçaları / Spare Parts / Ersatzteile			
	R	L	HF=H	B	LF	WF		CDX	Sıkma Vidası Screw Klemmschraube	Pul Stamp Ring	Anahtar Allen Key Innensechskantschlüssel
ADKT-151.22-R/L-1616-2-T15	●	●	16	16	125	16.3	15	151.2 - 2	AKV-02-M6x22	ABPL-01	AAL-03-3
ADKT-151.22-R/L-2020-2-T15	●	●	20	20	125	20.3	15				
ADKT-151.22-R/L-2525-2-T15	●	●	25	25	150	25.3	15	151.2 - 3	2004-M8x1x20	-	AAL-05-4
ADKT-151.22-R/L-1616-3-T15	●	●	16	16	125	16.4	15				
ADKT-151.22-R/L-2020-3-T20	●	●	20	20	125	20.4	20	151.2 - 4	2004-M8x1x20	-	AAL-05-4
ADKT-151.22-R/L-2525-3-T22	●	●	25	25	150	25.4	22				
ADKT-151.22-R/L-1616-4-T15	●	●	16	16	125	16.4	15	151.2 - 5	2004-M8x1x20	-	AAL-05-4
ADKT-151.22-R/L-2020-4-T20	●	●	20	20	125	20.4	20				
ADKT-151.22-R/L-2525-4-T22	●	●	25	25	150	25.4	22	151.2 - 3	2004-M8x1x20	-	AAL-05-4
ADKT-151.22-R/L-2020-5-T20	●	●	20	20	125	20.5	20				
ADKT-151.22-R/L-2525-5-T25	●	●	25	25	150	25.5	25	151.2 - 2.5	AKV-02-M6x22	ABPL-01	AAL-03-3
ADKT-151.23-R/L-1616-2-T15	●	●	16	16	125	16.3	15				
ADKT-151.23-R/L-2020-2-T15	●	●	20	20	125	20.3	15	151.2 - 2.5	AKV-02-M6x22	ABPL-01	AAL-03-3
ADKT-151.23-R/L-2525-2-T15	●	●	25	25	150	25.3	15				
ADKT-151.23-R/L-1616-2.5-T15	●	●	16	16	125	16.3	15	151.2 - 3	2004-M8x1x20	-	AAL-05-4
ADKT-151.23-R/L-2020-2.5-T15	●	●	20	20	125	20.3	15				
ADKT-151.23-R/L-2525-2.5-T15	●	●	25	25	150	25.3	15	151.2 - 4	2004-M8x1x20	-	AAL-05-4
ADKT-151.23-R/L-1212-3-T15	●	●	12	12	100	16.4	15				
ADKT-151.23-R/L-1616-3-T15	●	●	16	16	125	16.4	15	151.2 - 5	2004-M8x1x20	-	AAL-05-4
ADKT-151.23-R/L-2020-3-T20	●	●	20	20	125	20.4	20				
ADKT-151.23-R/L-2525-3-T20	●	●	25	25	150	25.4	20	151.2 - 4	2004-M8x1x20	-	AAL-05-4
ADKT-151.23-R/L-2525-3-T22	●	●	25	25	150	25.4	22				
ADKT-151.23-R/L-1616-4-T15	●	●	16	16	125	16.4	15	151.2 - 5	2004-M8x1x20	-	AAL-05-4
ADKT-151.23-R/L-2020-4-T20	●	●	20	20	125	20.4	20				
ADKT-151.23-R/L-2525-4-T22	●	●	25	25	150	25.4	22	151.2 - 5	2004-M8x1x20	-	AAL-05-4
ADKT-151.23-R/L-2020-5-T20	●	●	20	20	125	20.5	20				
ADKT-151.23-R/L-2525-5-T25	●	●	25	25	150	25.5	25				

R: Sağ / Right / Rechts L: Sol / Left / Links

● Stokta / In Stock / Auf Lager ○ Stokta Yok / Non Stock Item / Kein Lagerartikel, Lieferzeit auf Anfrage

SNDVK Ucuna Uygundur. / Compatible with SNDVK Insert. / Kompatibel mit SNDVK Wendeplatten.

Sipariş Örneği/Ordering Example/Bestellbeispiel

1 ad./pcs./stück ADKT-151.22-R-1616-2-T15

SNDVK Ucuna Uygun. / Compatible with SNDVK Insert. / Kompatibel mit SNDVK Wendeplatten.

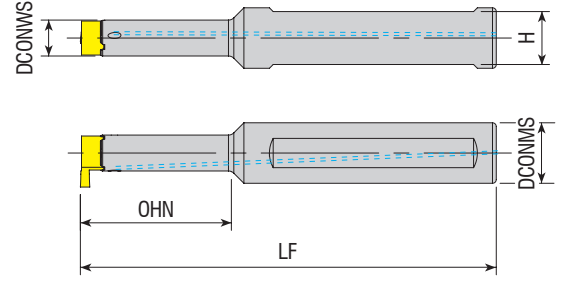

Takım Kodu Ordering Code Bestell-Bezeichnung	Stok Stock Lager		Takım Ölçüleri (mm) Dimension (mm) Abmessung (mm)				Kesici Uç Insert Wendeschneidplatte	Yedek Parçaları / Spare Parts / Ersatzteile		
			DCONMS	DCONWS	LF	OHN		H	Sıkma Vidası Screw Klemmschraube	Tork Anahtar Torx Key Torx Innensechskantschlüssel
AIKT-MB07-A16-090-15	●		16	7.4	90	15	14	MB - 07	4008-M3x8	82-T08
AIKT-MB07-A16-090-22	●		16	7.4	90	22	14			
AIKT-MB09-A16-090-19	●		16	9.5	90	19	14	MB - 09	4015-M4x11	80-T15
AIKT-MB09-A16-095-28	●		16	9.5	95	28	14			
AIKT-MB09-A16-110-40	●		16	9.5	110	40	14			

SNDVK Ucuna Uygun. / Compatible with SNDVK Insert. / Kompatibel mit SNDVK Wendeplatten.

TGTC Ucuna Uygun. / Compatible with TGTC Insert. / Kompatibel mit TGTC Wendeplatten.

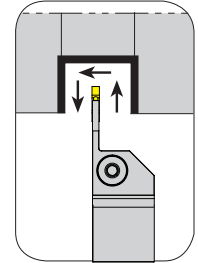
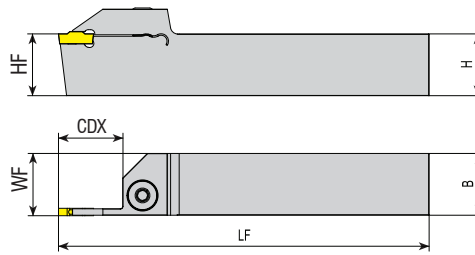

Takım Kodu Ordering Code Bestell-Bezeichnung	Stok Stock Lager		Takım Ölçüleri (mm) Dimension (mm) Abmessung (mm)				Kesici Uç Insert Wendeschneidplatte	Yedek Parçaları / Spare Parts / Ersatzteile				
	R	L	HF=H	B	LF	WF		CDX	Sıkma Vidası Screw Klemmschraube	Pul Stamp Ring	Anahtar Allen Key Innensechskantschlüssel	Tork Anahtar Torx Key Torx Innensechskantschlüssel
ADKT-RD-R/L-1616-2-T17	●	○	16	16	125	16.2	17	RD - 2	AKV-02-M6x22	ABPL-01	AAL-03-3	
ADKT-RD-R/L-2020-2-T17	●	○	20	20	125	20.2	17					
ADKT-RD-R/L-2525-2-T17	●	○	25	25	150	25.2	17					
ADKT-RD-R/L-1616-3-T20	●	●	16	16	125	16.3	20	RD - 3	2004-M8x1x20	-	AAL-05-4	
ADKT-RD-R/L-2020-3-T25	●	○	20	20	125	20.3	25					
ADKT-RD-R/L-2525-3-T25	●	○	25	25	150	25.3	25					
ADKT-RD-R/L-2020-4-T30	●	●	20	20	125	20.4	30	RD - 4	-	-	-	
ADKT-RD-R/L-2525-4-T30	●	○	25	25	150	25.5	30					

R: Sağ / Right / Rechts L: Sol / Left / Links

● Stokta / In Stock / Auf Lager ○ Stokta Yok / Non Stock Item / Kein Lagerartikel, Lieferzeit auf Anfrage

TGTC Ucuna Uygun. / Compatible with TGTC Insert. / Kompatibel mit TGTC Wendeplatten.

Sipariş Örneği/Ordering Example/Bestellbeispiel

1 ad./pcs./stück AIKT-MB07-A16-090-15

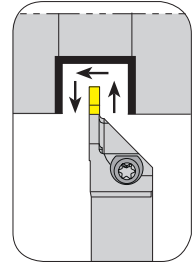
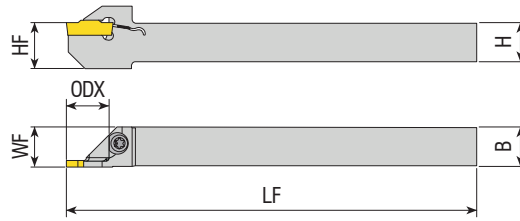

Takım Kodu
Ordering Code
Bestell-Bezeichnung

Takım Kodu Ordering Code Bestell-Bezeichnung	Stok Stock Lager		Takım Ölçüleri (mm) Dimension (mm) Abmessung (mm)				Kesici Uç Insert Wendeschneidplatte	Yedek Parçaları / Spare Parts / Ersatzteile			
	R	L	HF=H	B	LF	WF		CDX	Sıkma Vidası Screw Klemmschraube	Pul Stamp Ring	Tork Anahtar Torx Key Torx Innensechskantschlüssel
ADKT-RD-R/L-1212-2-T12-K-S	●	●	12	12	125	12.2	12	RD. - 2	4015-M4x11	-	80-T15
ADKT-RD-R/L-1616-2-T17-K-S	●	●	16	16	125	16.2	17				
ADKT-RD-R/L-1212-3-T12-K-S	●	●	12	12	125	12.2	12	RD. - 3			

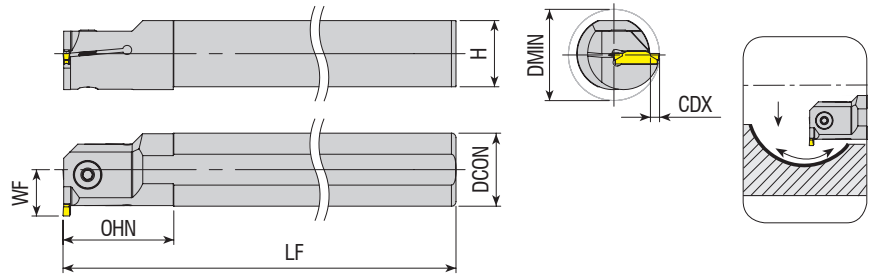

Takım Kodu Ordering Code Bestell-Bezeichnung	Stok Stock Lager		Takım Ölçüleri (mm) Dimension (mm) Abmessung (mm)						Kesici Uç Insert Wendeschneidplatte	Yedek Parçaları / Spare Parts / Ersatzteile		
	R	L	DCON	DMIN	LF	OHN	CDX	H		WF	Sıkma Vidası Screw Klemmschraube	Anahtar Allen Key Innensechskantschlüssel
AIKT-RD-R/L-16-2-T6	●	○	16	24	150	28	6	14.8	14	RD. - 2	2503-M4x10	AAL-03-3
AIKT-RD-R/L-20-2-T6	●	○	20	28	170	28	6	18.3	16		2504-M5x16	AAL-05-4
AIKT-RD-R/L-25-2-T6	●	○	25	33	200	28	6	23	18.5	RD. - 3	2503-M4x10	AAL-03-3
AIKT-RD-R/L-16-3-T6	●	○	16	24	150	28	6	14.8	14		2504-M5x12	AAL-05-4
AIKT-RD-R/L-20-3-T6	●	○	20	28	170	28	6	18.3	16	2504-M5x16		
AIKT-RD-R/L-25-3-T6	●	○	25	33	200	28	6	23	18.5	2004-M8x1x20		
AIKT-RD-R/L-32-3-T6	●	○	32	40	250	50	6	30	22	RD. - 4	2504-M5x12	
AIKT-RD-R/L-20-4-T6	●	○	20	28	170	28	6	18.3	16		2504-M5x16	
AIKT-RD-R/L-25-4-T6	●	○	25	33	200	28	6	23	18.5	2004-M8x1x20		
AIKT-RD-R/L-32-4-T6	●	○	32	40	250	50	6	30	22			

R: Sağ / Right / Rechts L: Sol / Left / Links

● Stokta / In Stock / Auf Lager ○ Stokta Yok / Non Stock Item / Kein Lagerartikel, Lieferzeit auf Anfrage

TGTC Ucuna Uygun. / Compatible with TGTC Insert. / Kompatibel mit TGTC Wendeplatten.

Sipariş Örneği/Ordering Example/Bestellbeispiel

1 ad./pcs./stück ADKT-RD-R-1212-2-T12-K-S

TGTC Ucuna Uygundur. / Compatible with TGTC Insert. / Kompatibel mit TGTC Wendeplatten.

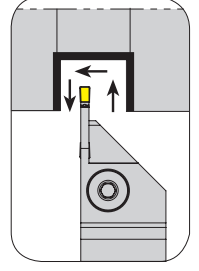
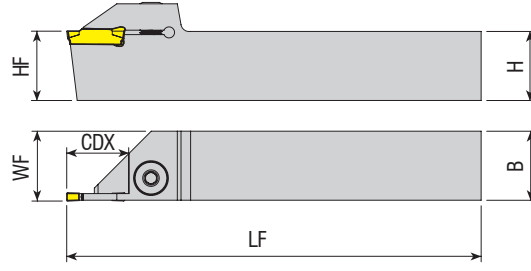

Takım Kodu Ordering Code Bestell-Bezeichnung	Stok Stock Lager		Takım Ölçüleri (mm) Dimension (mm) Abmessung (mm)				Kesici Uç Insert Wendeschneidplatte	Yedek Parçaları / Spare Parts / Ersatzteile			
	R	L	HF=H	B	LF	WF		CDX	Sıkma Vidası Screw Klemmschraube	Pul Stamp Ring	Anahtar Allen Key Innensechskantschlüssel
ADKT-TD-R/L-1212-2-T15	●	●	12	12	100	12.2	15	TD. - 2	AKV-02-M6x22	ABPL-01	AAL-03-3
ADKT-TD-R/L-1616-2-T8	●	●	16	16	125	16.2	8				
ADKT-TD-R/L-1616-2-T15	●	●	16	16	125	16.2	15				
ADKT-TD-R/L-2020-2-T9	●	○	20	20	125	20.2	9				
ADKT-TD-R/L-2020-2-T15	●	●	20	20	125	20.2	15				
ADKT-TD-R/L-2020-2-T17	●	○	20	20	125	20.2	17				
ADKT-TD-R/L-2020-2-T20	●	○	20	20	125	20.2	20				
ADKT-TD-R/L-2525-2-T8	●	●	25	25	150	25.2	8				
ADKT-TD-R/L-2525-2-T17	●	●	25	25	150	25.2	17				
ADKT-TD-R/L-1212-3-T15	●	●	12	12	100	12.4	15				
ADKT-TD-R/L-1616-3-T15	●	●	16	16	125	16.4	15				
ADKT-TD-R/L-2020-3-T12	●	●	20	20	125	20.4	12				
ADKT-TD-R/L-2020-3-T20	●	●	20	20	125	20.4	20				
ADKT-TD-R/L-2020-3-T25	●	○	20	20	125	20.4	25				
ADKT-TD-R/L-2020-3-T30	●	●	20	20	125	20.4	30				
ADKT-TD-R/L-2525-3-T9	●	●	25	25	150	25.4	9				
ADKT-TD-R/L-2525-3-T12	●	●	25	25	150	25.4	12				
ADKT-TD-R/L-2525-3-T22	●	●	25	25	150	25.4	22				
ADKT-TD-R/L-2525-3-T25	●	●	25	25	150	25.4	25				
ADKT-TD-R/L-2525-3-T30	●	●	25	25	150	25.4	30	TD. - 4			
ADKT-TD-R/L-3232-3-T25	●	○	32	32	170	32.4	25				
ADKT-TD-R/L-2525-4-T10	●	●	25	25	150	25.5	10				
ADKT-TD-R/L-2525-4-T15	●	●	25	25	150	25.5	15				
ADKT-TD-R/L-2525-4-T22	●	●	25	25	150	25.5	22				
ADKT-TD-R/L-2525-4-T25	●	○	25	25	150	25.4	25	TD. - 5			
ADKT-TD-R/L-2525-4-T30	●	○	25	25	150	25.5	30				
ADKT-TD-R/L-2525-5-T25	●	●	25	25	150	25.5	25				

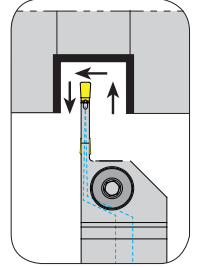
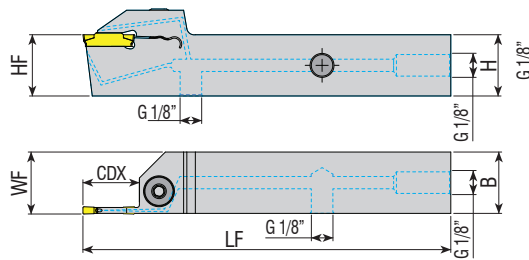

Takım Kodu Ordering Code Bestell-Bezeichnung	Stok Stock Lager		Takım Ölçüleri (mm) Dimension (mm) Abmessung (mm)				Kesici Uç Insert Wendeschneidplatte	Yedek Parçaları / Spare Parts / Ersatzteile			
	R	L	HF=H	B	LF	WF		CDX	Sıkma Vidası Screw Klemmschraube	Pul Stamp Ring	Anahtar Allen Key Innensechskantschlüssel
ADKT-TD-R/L-2020-3-T30-H	●	●	20	20	125	20.5	30	TD. - 3	2004-M8x1x20	-	AAL-05-4

R: Sağ / Right / Rechts L: Sol / Left / Links

● Stokta / In Stock / Auf Lager ○ Stokta Yok / Non Stock Item / Kein Lagerartikel, Lieferzeit auf Anfrage

TGTC Ucuna Uygundur. / Compatible with TGTC Insert. / Kompatibel mit TGTC Wendeplatten.

Sipariş Örneği/Ordering Example/Bestellbeispiel

1 ad./pcs./stück ADKT-TD-R-1212-2-T15

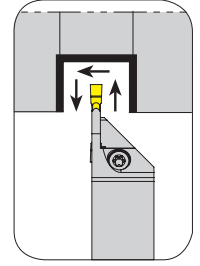
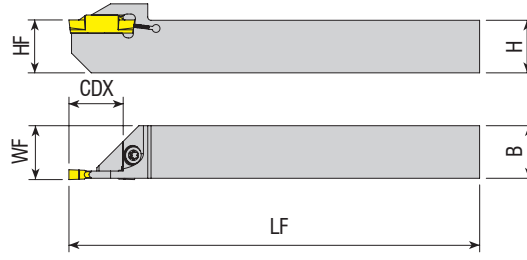

Takım Kodu Ordering Code Bestell-Bezeichnung	Stok Stock Lager		Takım Ölçüleri (mm) Dimension (mm) Abmessung (mm)				Kesici Uç Insert Wendeschneidplatte	Yedek Parçaları / Spare Parts / Ersatzteile			
	R	L	HF=H	B	LF	WF		CDX	Sıkma Vidası Screw Klemmschraube	Pul Stamp Ring	Tork Anahtar Torx Key Torx Innensechskantschlüssel
ADKT-TD-R/L-1010-2-R10-K-S	●	●	10	10	125	10.2	10	TD. - 2	4015-M4x11	-	80-T15
ADKT-TD-R/L-1212-2-T12-K-S	●	●	12	12	125	12.2	12				
ADKT-TD-R/L-1616-2-T16-K-S	●	●	16	16	125	16.2	16	TD. - 3			
ADKT-TD-R/L-1212-3-T12-K-S	●	●	12	12	125	12.3	12				
ADKT-TD-R/L-1616-3-T16-K-S	●	●	16	16	125	16.3	16				

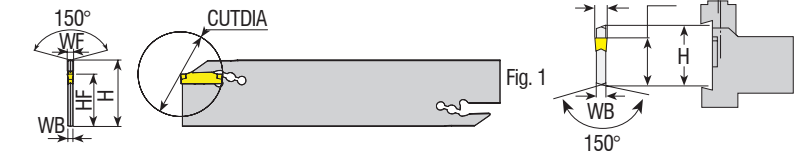
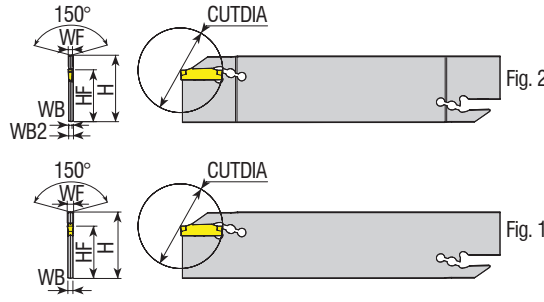

Takım Kodu Ordering Code Bestell-Bezeichnung	Stok Stock Lager	Takım Ölçüleri (mm) Dimension (mm) Abmessung (mm)								Kesici Uç Insert Wendeschneidplatte	Yedek Parçaları / Spare Parts / Ersatzteile
		H	WF	WB2	WB	I	HF	CUTDIA	Fig.		Anahtar Allen Key Innensechskantschlüssel
AKL-TD-32-2	●	32	2	2.4	1.6	150	25	39	2	TD. - 2	ALA-02
AKL-TD-26-3	●	26	3	-	2.40	110	26	40	1	TD. - 3	
AKL-TD-32-3	●	32	3	2.4	-	150	25	39	1	TD. - 4	
AKL-TD-26-4	●	26	4	-	3.20	110	26	40	1	TD. - 5	
AKL-TD-32-5	●	32	5	-	4	150	25	40	1		

Blok bilgileri için sayfa 155'ye gidin. / For block information, go to page 155. / Informationen zu den spannblock finden Sie auf Seite 155.

TGTC Ucuna Uygundur. / Compatible with TGTC Insert. / Kompatibel mit TGTC Wendeplatten.

Sipariş Örneği/Ordering Example/Bestellbeispiel

1 ad./pcs./stück ADKT-TD-R-1010-2-R10-K-S

TGTC Ucuna Uygundur. / Compatible with TGTC Insert. / Kompatibel mit TGTC Wendeplatten.

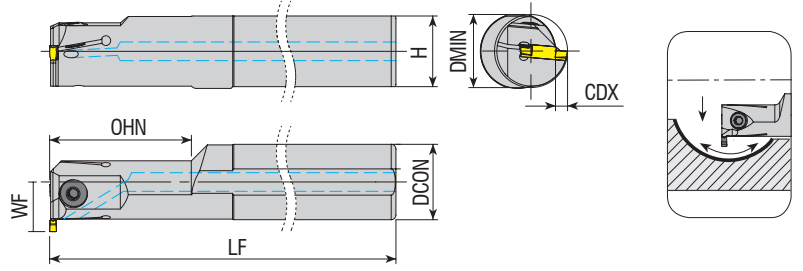

Takım Kodu
Ordering Code
Bestell-Bezeichnung

Stok
Stock
Lager

Takım Ölçüleri (mm)
Dimension (mm)
Abmessung (mm)

Kesici Uç
Insert
Wendeschneidplatte

Yedek Parçaları / Spare Parts / Ersatzteile

Sıkma Vidası
Screw
Klemmschraube

Anahtar
Allen Key
Innensechskantschlüssel

R

L

DCON

DMIN

LF

OHN

CDX

H

WF



AIKT-TD-R/L-16-2-T8.5-H

● ○

16

25

150

28

8.5

14.8

16.5

TD - 2

2503-M4x10

AAL-03-3

AIKT-TD-R/L-20-3-T6-H

● ○

20

25

170

40

6

18.3

16

TD - 3

2504-M5x12

AAL-05-4

AIKT-TD-R/L-25-3-T6-H

● ○

25

25

200

40

6

23

18.5

TD - 3

2504-M5x16

AAL-05-4

AIKT-TD-R/L-32-3-T5-H

● ○

32

31

250

60

5

30

21

TD - 3

2004-M8x1x20

AAL-05-4

new

AIKT-TD-R/L-32-3-T10-H

● ○

32

36

250

78

10

30

26

TD - 3

2004-M8x1x20

AAL-05-4

new

AIKT-TD-R/L-40-3-T12-H

● ○

40

45

300

78

12

37.5

12

TD - 3

2004-M8x1x20

AAL-05-4

AIKT-TD-R/L-20-4-T10-H

○ ●

20

27

170

40

10

18.3

20

TD - 4

2504-M5x12

AAL-05-4

AIKT-TD-R/L-25-4-T10-H

○ ●

25

31

200

40

10

23

22.5

TD - 4

2504-M5x16

AAL-05-4

AIKT-TD-R/L-32-4-T10-H

○ ●

32

36

250

60

10

30

26

TD - 4

2004-M8x1x20

AAL-05-4

TGTC Ucuna Uygundur. / Compatible with TGTC Insert. / Kompatibel mit TGTC Wendeplatten.

TNGLY Ucuna Uygundur. / Compatible with TNGLY Insert. / Kompatibel mit TNGLY Wendeplatten.

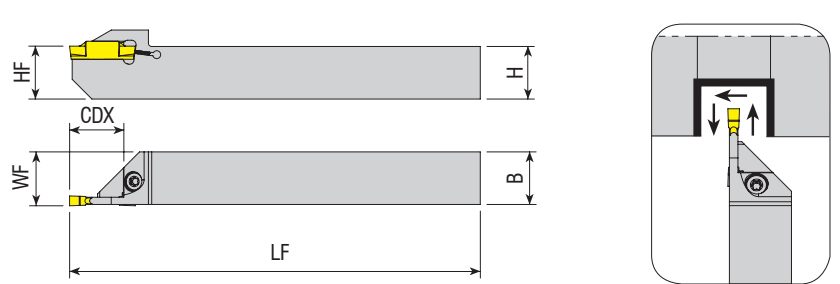

Takım Kodu
Ordering Code
Bestell-Bezeichnung

Stok
Stock
Lager

Takım Ölçüleri (mm)
Dimension (mm)
Abmessung (mm)

Kesici Uç
Insert
Wendeschneidplatte

Yedek Parçaları / Spare Parts / Ersatzteile

Sıkma Vidası
Screw
Klemmschraube

Pul
Stamp
Ring

Tork Anahtar
Torx Key
Torx Innensechskantschlüssel

R

L

HF=H

B

LF

WF

CDX



ADKT-TG-R/L-1212-2-R12-K-S

● ○

12

12

125

12.2

12

DGM2-020

4015-M4x11

-

80-T15

ADKT-TG-R/L-1212-3-R12-K-S

● ○

12

12

125

12.3

12

DGM3-020

4015-M4x11

-

80-T15

R: Sağ / Right / Rechts L: Sol / Left / Links

● Stokta / In Stock / Auf Lager ○ Stokta Yok / Non Stock Item / Kein Lagerartikel, Lieferzeit auf Anfrage

TNGLY Ucuna Uygundur. / Compatible with TNGLY Insert. / Kompatibel mit TNGLY Wendeplatten.

Sipariş Örneği/Ordering Example/Bestellbeispiel
1 ad./pcs./stück AIKT-TD-R-16-2-T8.5-H

TNGLY Ucuna Uygundur. / Compatible with TNGLY Insert. / Kompatibel mit TNGLY Wendeplatten.

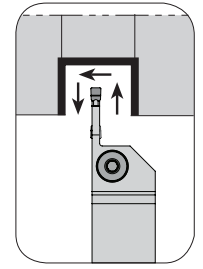
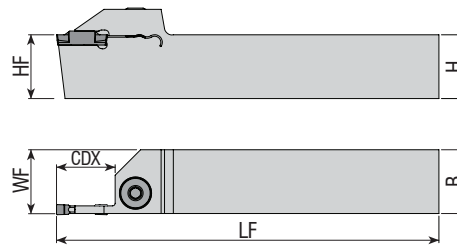

Takım Kodu Ordering Code Bestell-Bezeichnung	Stok Stock Lager		Takım Ölçüleri (mm) Dimension (mm) Abmessung (mm)					Kesici Uç Insert Wendeschneidplatte	Yedek Parçaları / Spare Parts / Ersatzteile			
	R	L	HF=H	B	LF	WF	CDX		Sıkma Vidası Screw Klemmschraube	Pul Stamp Ring	Anahtar Allen Key Innensechskantschlüssel	
ADKT-TG-R/L-1616-2-R17	●	○	16	16	125	16.2	17	DGM2-020	AKV-02-M6x22	ABPL-01	AAL-03-3	
ADKT-TG-R/L-2020-2-T8	●	○	20	20	125	20.2	8					
ADKT-TG-R/L-2020-2-R12	●	○	20	20	125	20.2	12					
ADKT-TG-R/L-2020-2-R17	●	○	20	20	125	20.2	17					
ADKT-TG-R/L-2525-2-T12	●	○	25	25	150	25.2	12					
ADKT-TG-R/L-2525-2-R17	●	○	25	25	150	25.2	17	DGM3-020	2004-M8x1x20	-	AAL-05-4	
ADKT-TG-R/L-1616-3-T20	●	○	16	16	125	16.3	20					
ADKT-TG-R/L-2020-3-T12	●	○	20	20	125	20.3	12					
ADKT-TG-R/L-2020-3-T20	●	○	20	20	125	20.3	20					
ADKT-TG-R/L-2525-3-T9	●	○	25	25	150	25.3	9					
ADKT-TG-R/L-2525-3-T20	●	○	25	25	150	25.3	20					
ADKT-TG-R/L-2525-3-R25	●	○	25	25	150	25.3	25					
ADKT-TG-R/L-2525-4-T15	●	○	25	25	150	25.5	15					
ADKT-TG-R/L-2525-4-T20	●	○	25	25	150	25.5	20					
ADKT-TG-R/L-2525-4-T25	●	○	25	25	150	25.5	25					
ADKT-TG-R/L-2525-5-T12	●	○	25	25	150	25.5	12	DGM4-030	2004-M8x1x20	-	AAL-05-4	
ADKT-TG-R/L-2525-5-T25	●	○	25	25	150	25.5	25					
ADKT-TG-R/L-2525-5-T32	●	○	25	25	150	25.5	32					

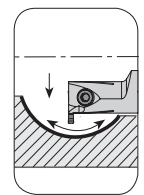
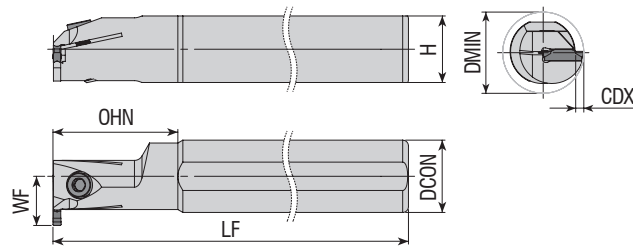

Takım Kodu Ordering Code Bestell-Bezeichnung	Stok Stock Lager		Takım Ölçüleri (mm) Dimension (mm) Abmessung (mm)						Kesici Uç Insert Wendeschneidplatte	Yedek Parçaları / Spare Parts / Ersatzteile		
	R	L	DCON	DMIN	LF	OHN	CDX	H		WF	Sıkma Vidası Screw Klemmschraube	Tork Anahtar Torx Key Torx Innensechskantschlüssel
AIKT-TG-R/L-20-2-T6	●	○	20	28	160	28	6	18.3	15.8	DGM2-020	2503-M4x10 2504-M5x12 2504-M5x16	AAL-03-3
AIKT-TG-R/L-20-3-T6	●	○	20	28	160	28	6	18.3	15.8			
AIKT-TG-R/L-25-3-T8	●	○	25	35	200	28	8	23	21.5			
AIKT-TG-R/L-32-3-T10	●	○	32	43	250	50	10	30	27	DTX3-030	2004-M8x1x20	AAL-05-4
AIKT-TG-R/L-32-3-T12	●	○	32	45	250	50	12	30	27			
AIKT-TG-R/L-32-4-T10	●	○	32	43	250	50	10	30	27	DTX4-040 DTX5-040	2004-M8x1x20	AAL-05-4
AIKT-TG-R/L-32-5-T10	●	○	32	43	250	50	10	30	27			

R: Sağ / Right / Rechts L: Sol / Left / Links

● Stokta / In Stock / Auf Lager ○ Stokta Yok / Non Stock Item / Kein Lagerartikel, Lieferzeit auf Anfrage

TNGLY Ucuna Uygundur. / Compatible with TNGLY Insert. / Kompatibel mit TNGLY Wendeplatten.

Sipariş Örneği/Ordering Example/Bestellbeispiel

1 ad./pcs./stück ADKT-TG-R-1616-2-R17

WLTR Ucuna Uygundur. / Compatible with WLTR Insert. / Kompatibel mit WLTR Wendeplatten.

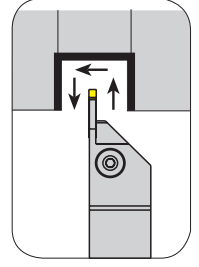
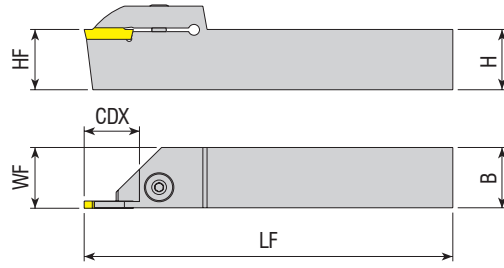

Takım Kodu
Ordering Code
Bestell-Bezeichnung

Stok
Stock
Lager

Takım Ölçüleri (mm)
Dimension (mm)
Abmessung (mm)

Kesici Uç
Insert
Wendeschneidplatte

Yedek Parçaları / Spare Parts / Ersatzteile

Sıkma Vidası
Screw
Klemmschraube

Pul
Stamp
Ring

Anahtar
Allen Key
Innensechskantschlüssel

R

L

HF=H

B

LF

WF

CDX

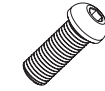

ADKT-WGX16-R/L-2020-2-R16

●

○

20

20

125

20.2

16

GX16. - 2

AKV-02-M6x22

ABPL-01

AAL-03-3

ADKT-WGX16-R/L-2525-2-R16

●

○

25

25

150

25.2

16

ADKT-WGX24-R/L-2020-3-T20

●

●

20

20

125

20.4

20

ADKT-WGX24-R/L-2525-3-T12

●

●

25

25

150

25.4

12

ADKT-WGX24-R/L-2525-3-T22

●

●

25

25

150

25.4

22

ADKT-WGX24-R/L-3232-3-T22

●

○

32

32

170

32.4

22

ADKT-WGX24-R/L-2525-4-T22

●

●

25

25

150

25.5

22

GX24. - 4

ADKT-WGX24-R/L-2525-5-T25

●

●

25

25

150

25.5

25

GX24. - 5

ADKT-WGX24-R/L-3232-5-T25

●

●

32

32

170

32.5

25

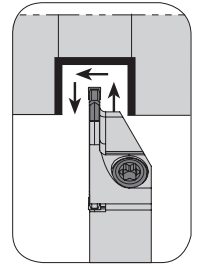
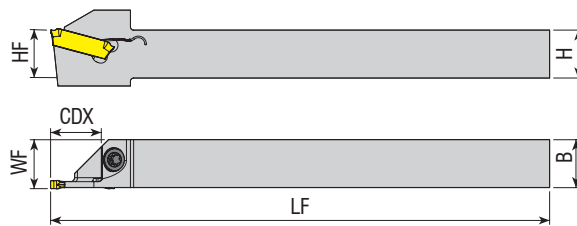

Takım Kodu
Ordering Code
Bestell-Bezeichnung

Stok
Stock
Lager

Takım Ölçüleri (mm)
Dimension (mm)
Abmessung (mm)

Kesici Uç
Insert
Wendeschneidplatte

Yedek Parçaları / Spare Parts / Ersatzteile

Sıkma Vidası
Screw
Klemmschraube

Pul
Stamp
Ring

Tork Anahtar
Torx Key
Torx Innensechskantschlüssel

R

L

HF=H

B

LF

WF

CDX

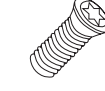

ADKT-WGX16-R/L-1212-2-R12-K-S

●

●

12

12

125

12.2

12

GX16. - 2

4015-M4x11

-

80-T15

ADKT-WGX16-R/L-1616-2-R16-K-S

●

○

16

16

125

16.2

16

ADKT-WGX24-R/L-1616-3-R16-K-S

●

○

16

16

125

16.3

16

GX24. - 3

R: Sağ / Right / Rechts L: Sol / Left / Links

● Stokta / In Stock / Auf Lager ○ Stokta Yok / Non Stock Item / Kein Lagerartikel, Lieferzeit auf Anfrage

WLTR Ucuna Uygundur. / Compatible with WLTR Insert. / Kompatibel mit WLTR Wendeplatten.

Sipariş Örneği/Ordering Example/Bestellbeispiel

1 ad./pcs./stück ADKT-WGX16-R-2020-2-R16

WLTR Ucuna Uygundur. / Compatible with WLTR Insert. / Kompatibel mit WLTR Wendeplatten.

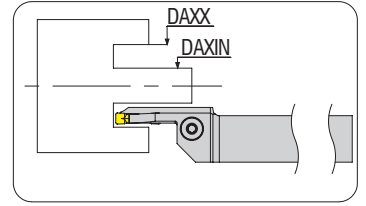
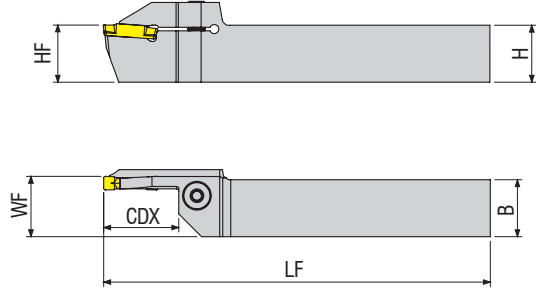
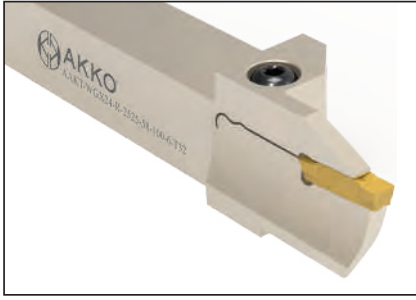

Takım Kodu
Ordering Code
Bestell-Bezeichnung

Stok
Stock
Lager

Takım Ölçüleri (mm)
Dimension (mm)
Abmessung (mm)

Kesici Uç
Insert
Wendeschneidplatte

Yedek Parçaları / Spare Parts / Ersatzteile

Sıkma Vidası
Screw
Klemmschraube

Pul
Stamp
Ring

Anahtar
Allen Key
Innensechskantschlüssel

AAKT-WGX24-R-L-2525-58-100-6-T32
AAKT-WGX24-R-L-2525-88-180-6-T32

R L

HF=H

B

LF

WF

CDX

DAXIN

DAXX

GX24-6

2004-M8x1x20

-

AAL-05-4

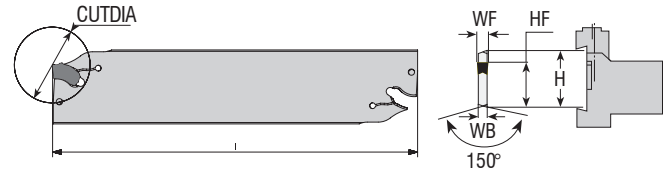
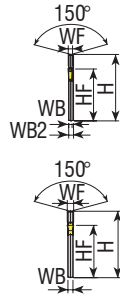

Takım Kodu
Ordering Code
Bestell-Bezeichnung

Stok
Stock
Lager

Takım Ölçüleri (mm)
Dimension (mm)
Abmessung (mm)

Kesici Uç
Insert
Wendeschneidplatte

Yedek Parçaları / Spare Parts
Ersatzteile

Anahtar
Allen Key
Innensechskantschlüssel

AKL-SX-32-3
AKL-SX-32-4
AKL-SX-32-5
AKL-SX-32-6

H

WF

WB2

WB

I

HF

CUTDIA

Fig.

SX-3E.300N

SX-4E.400N

SX-5E.500N

SX-5E.600N

ALA-04

R: Sağ / Right / Rechts L: Sol / Left / Links

● Stokta / In Stock / Auf Lager ○ Stokta Yok / Non Stock Item / Kein Lagerartikel, Lieferzeit auf Anfrage

Blok bilgileri için sayfa 155'ye gidin. / For block information, go to page 155. / Informationen zu den spannblock finden Sie auf Seite 155.

WLTR Ucuna Uygundur. / Compatible with WLTR Insert. / Kompatibel mit WLTR Wendeplatten.

Sipariş Örneği/Ordering Example/Bestellbeispiel
1 ad./pcs./stück AAKT-WGX24-R-2525-58-100-6-T32

XTC-GSC Ucuna Uygundur. / Compatible with **XTC-GSC** Insert. / Kompatibel mit **XTC-GSC** Wendeplatten.

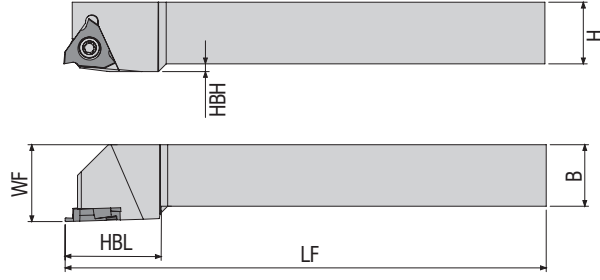

Takım Kodu Ordering Code Bestell-Bezeichnung	Stok Stock Lager		Takım Ölçüleri (mm) Dimension (mm) Abmessung (mm)				Kesici Uç Insert Wendeschneidplatte	Yedek Parçaları / Spare Parts / Ersatzteile			
	R	L	HF=H	B	LF	WF		Sıkma Vidası Screw Klemmschraube	Pul Stamp Ring	Tork Anahtar Torx Key Torx Innensechskantschlüssel	
ADKT-GB-R/L-1212-3	●	○	12	12	100	16	GB3100	4015-M3.5x10	-	80-T15	
ADKT-GB-R/L-1616-3	●	○	16	16	125	20					
ADKT-GB-R/L-2020-3	●	○	20	20	125	25					

XTC-GSC Ucuna Uygundur. / Compatible with **XTC-GSC** Insert. / Kompatibel mit **XTC-GSC** Wendeplatten.

ZCC Ucuna Uygundur. / Compatible with **ZCC** Insert. / Kompatibel mit **ZCC** Wendeplatten.

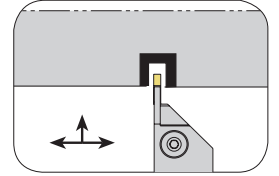
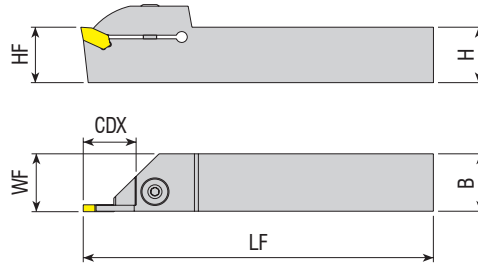
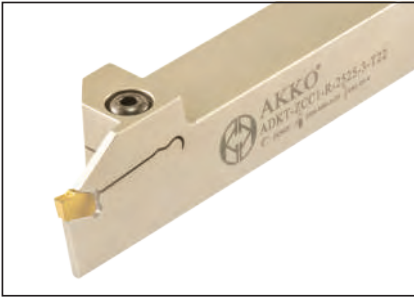

Takım Kodu Ordering Code Bestell-Bezeichnung	Stok Stock Lager		Takım Ölçüleri (mm) Dimension (mm) Abmessung (mm)				Kesici Uç Insert Wendeschneidplatte	Yedek Parçaları / Spare Parts / Ersatzteile			
	R	L	HF=H	B	LF	WF		CDX	Sıkma Vidası Screw Klemmschraube	Pul Stamp Ring	Anahtar Allen Key Innensechskantschlüssel
ADKT-ZCC1-R/L-2020-3-T20	●	○	20	20	125	20.3	20	ZQMX - 3	2004-M8x1x20	-	AAL-05-4
ADKT-ZCC1-R/L-2525-3-T22	●	○	25	25	150	25.3	22				
ADKT-ZCC1-R/L-2020-4-T20	●	○	20	20	125	20.4	20	ZQMX - 4	-	-	-
ADKT-ZCC1-R/L-2525-4-T22	●	○	25	25	150	25.4	22				

R: Sağ / Right / Rechts L: Sol / Left / Links

● Stokta / In Stock / Auf Lager ○ Stokta Yok / Non Stock Item / Kein Lagerartikel, Lieferzeit auf Anfrage

ZCC Ucuna Uygundur. / Compatible with **ZCC** Insert. / Kompatibel mit **ZCC** Wendeplatten.

Sipariş Örneği/Ordering Example/Bestellbeispiel

1 ad./pcs./stück ADKT-GB-R-1212-3

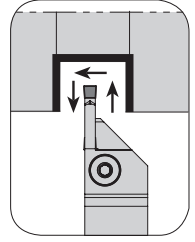
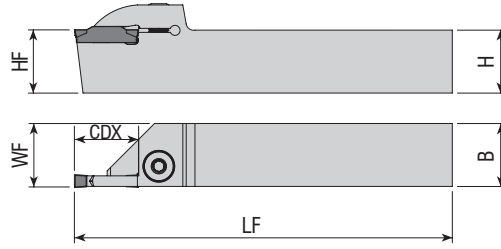

Takım Kodu
Ordering Code
Bestell-Bezeichnung

Stok
Stock
Lager

Takım Ölçüleri (mm)
Dimension (mm)
Abmessung (mm)

Kesici Uç
Insert
Wendeschneidplatte

Yedek Parçaları / Spare Parts / Ersatzteile

Sıkma Vidası
Screw
Klemmschraube

Pul
Stamp
Ring

Anahtar
Allen Key
Innensechskantschlüssel

R	L	HF=H	B	LF	WF	CDX	Kesici Uç Insert Wendeschneidplatte	Sıkma Vidası Screw Klemmschraube	Pul Stamp Ring	Anahtar Allen Key Innensechskantschlüssel	
ADKT-ZCC2-R/L-1616-2-T15	●	●	16	16	125	16.2	15	Z.BD - 2	AKV-02-M6x22	ABPL-01	AAL-03-3
ADKT-ZCC2-R/L-2020-2-T17	●	●	20	20	125	20.2	7				
ADKT-ZCC2-R/L-2020-2-T15	●	●	20	20	125	20.2	15				
ADKT-ZCC2-R/L-2525-2-T15	●	●	25	25	150	25.2	15	Z.ED - 2.5			
ADKT-ZCC2-R/L-1616-2.5-T15	●	●	16	16	125	16.3	15				
ADKT-ZCC2-R/L-2020-2.5-T17	●	●	20	20	125	20.3	17				
ADKT-ZCC2-R/L-2525-2.5-T15	●	●	25	25	150	25.3	15	Z.FD - 3			
ADKT-ZCC2-R/L-1616-3-T15	●	●	16	16	125	16.3	15				
ADKT-ZCC2-R/L-1616-3-T17	●	○	16	16	125	16.3	17				
ADKT-ZCC2-R/L-1616-3-T20	●	○	16	16	125	16.3	20	Z.GD - 4	2004-M8x1x20	-	AAL-05-4
ADKT-ZCC2-R/L-2020-3-T12	●	●	20	20	125	20.3	12				
ADKT-ZCC2-R/L-2020-3-T20	●	●	20	20	125	20.3	20				
ADKT-ZCC2-R/L-2020-3-R21	●	○	20	20	125	20.3	21	Z.HD - 5			
ADKT-ZCC2-R/L-2020-3-R25	●	●	20	20	125	20.3	25				
ADKT-ZCC2-R/L-2525-3-T12	●	○	25	25	150	25.3	12				
ADKT-ZCC2-R/L-2525-3-T22	●	●	25	25	150	25.3	22	Z.KD - 6			
ADKT-ZCC2-R/L-2525-3-R30	●	●	25	25	150	25.3	30				
ADKT-ZCC2-R/L-2020-4-T12	●	○	20	20	125	20.5	12				
ADKT-ZCC2-R/L-2020-4-T20	●	●	20	20	125	20.5	20	Z.HD - 5			
ADKT-ZCC2-R/L-2525-4-T12	●	●	25	25	150	25.5	12				
ADKT-ZCC2-R/L-2525-4-T22	●	●	25	25	150	25.5	22				
ADKT-ZCC2-R/L-2020-5-T12	●	○	20	20	125	20.5	12	Z.KD - 6			
ADKT-ZCC2-R/L-2020-5-T20	●	●	20	20	125	20.5	20				
ADKT-ZCC2-R/L-2525-5-T12	●	○	25	25	150	25.5	12				
ADKT-ZCC2-R/L-2525-5-T25	●	●	25	25	150	25.5	25	Z.KD - 6			
ADKT-ZCC2-R/L-3232-5-T25	●	●	32	32	170	32.5	25				
ADKT-ZCC2-R/L-2020-6-T20	●	●	20	20	125	20.6	20				
ADKT-ZCC2-R/L-2525-6-T25	●	●	25	25	150	25.6	25	Z.KD - 6			
ADKT-ZCC2-R/L-3232-6-T25	●	●	32	32	170	32.6	25				
ADKT-ZCC2-R/L-3232-6-T30	●	●	32	32	170	32.6	30				

R: Sağ / Right / Rechts L: Sol / Left / Links

● Stokta / In Stock / Auf Lager ○ Stokta Yok / Non Stock Item / Kein Lagerartikel, Lieferzeit auf Anfrage

ZCC Ucuna Uygundur. / Compatible with ZCC Insert. / Kompatibel mit ZCC Wendeplatten.

Sipariş Örneği/Ordering Example/Bestellbeispiel

1 ad./pcs./stück ADKT-ZCC2-R-1616-2-T15

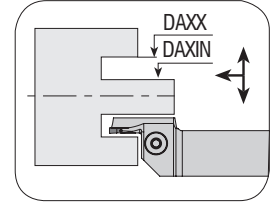
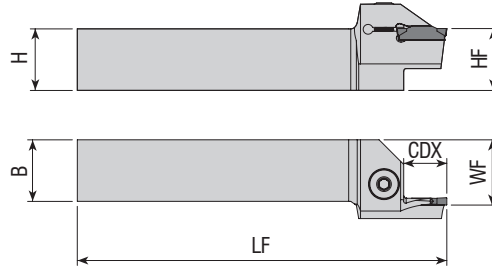

Takım Kodu Ordering Code Bestell-Bezeichnung	Takım Ölçüleri (mm) Dimension (mm) Abmessung (mm)									Kesici Uç Insert Wendeschneidplatte	Yedek Parçaları / Spare Parts / Ersatzteile		
	R	L	HF=H	B	LF	WF	CDX	DAXIN	DAXX		Sıkma Vidası Screw Klemmschraube	Pul Stamp Ring	Anahtar Allen Key Innensechskantschlüssel
AAKT-ZCC2-R/L-2525-140-180-2-T4	●	○	25	25	150	26.5	4	140	180	Z.BD - 2	2004-M8x1x20	-	AAL-05-4
AAKT-ZCC2-R/L-2525-35-45-3-T17	●	●	25	25	150	26.5	17	35	45	Z.FD - 3			
AAKT-ZCC2-R/L-2525-39-55-3-T17	●	○	25	25	150	26.5	17	39	55				
AAKT-ZCC2-R/L-2525-49-80-3-T17	●	●	25	25	150	26.5	17	49	80				
AAKT-ZCC2-R/L-2525-70-110-3-T15	●	○	25	25	150	26.5	15	70	110				
AAKT-ZCC2-R/L-2525-70-110-3-T17	●	●	25	25	150	26.5	17	70	110				
AAKT-ZCC2-R/L-2525-100-150-3-T17	●	●	25	25	150	26.5	17	100	150				
AAKT-ZCC2-R/L-2525-100-150-3-T22	●	●	25	25	150	26.5	22	100	150				
new AAKT-ZCC2-R/L-3232-135-175-3-T5	●	○	32	32	170	33.5	5	135	175	Z.HD-3			
new AAKT-ZCC2-R/L-3232-145-175-3-T15	●	○	32	32	170	33.5	15	145	175				
new AAKT-ZCC2-R/L-3232-155-185-3-T7	●	○	32	32	170	33.5	7	155	185				
new AAKT-ZCC2-R/L-3232-180-215-3-T5	●	○	32	32	170	33.5	5	180	215				
AAKT-ZCC2-R/L-2525-40-60-4-T22	●	○	25	25	150	26.5	22	40	60	Z.GD - 4			
AAKT-ZCC2-R/L-2525-52-80-4-T22	●	●	25	25	150	26.5	22	52	80				
AAKT-ZCC2-R/L-2525-72-110-4-T22	●	●	25	25	150	26.5	22	72	110				
AAKT-ZCC2-R/L-2525-100-150-4-T22	●	●	25	25	150	26.5	22	100	150				
AAKT-ZCC2-R/L-2525-140-200-4-T22	●	●	25	25	150	26.5	22	140	200				
new AAKT-ZCC2-R/L-3232-130-195-4-T10	●	○	32	32	170	33.5	10	130	195	Z.HD-4			
AAKT-ZCC2-R/L-2525-55-95-5-T25	●	○	25	25	150	26.5	25	55	95	Z.HD - 5			
AAKT-ZCC2-R/L-2525-85-140-5-T25	●	●	25	25	150	26.5	25	85	140				
new AAKT-ZCC2-R/L-2525-100-200-5-T45	●	○	25	25	150	26.5	45	100	200				
AAKT-ZCC2-R/L-2525-130-200-5-T25	●	●	25	25	150	26.5	25	130	200				
AAKT-ZCC2-R/L-2525-190-400-5-T25	●	○	25	25	150	26.5	25	190	400				
AAKT-ZCC2-R/L-2525-190-400-5-T35	●	○	25	25	150	26.5	35	190	400				
new AAKT-ZCC2-R/L-3232-150-215-5-T10	●	○	32	32	170	33.5	10	150	215				
AAKT-ZCC2-R/L-2525-200-500-5-T17	●	●	25	25	150	26.5	17	200	500	Z.KD - 6			
AAKT-ZCC2-R/L-2525-60-110-6-T15	●	○	25	25	150	26.5	15	60	110				
AAKT-ZCC2-R/L-3232-160-400-6-T25	○	●	32	32	170	33.5	25	160	400				

R: Sağ / Right / Rechts L: Sol / Left / Links

● Stokta / In Stock / Auf Lager ○ Stokta Yok / Non Stock Item / Kein Lagerartikel, Lieferzeit auf Anfrage

ZCC Ucuna Uygundur. / Compatible with ZCC Insert. / Kompatibel mit ZCC Wendeplatten.

Sipariş Örneği/Ordering Example/Bestellbeispiel
1 ad./pcs./stück AAKT-ZCC2-R-2525-140-180-2-T4

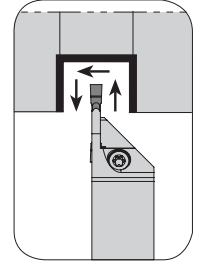
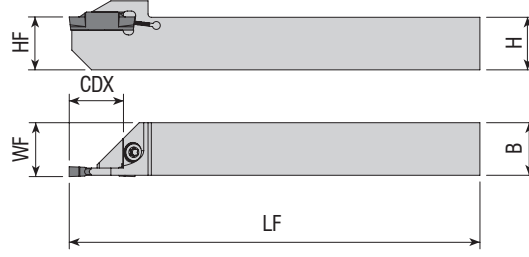

Takım Kodu Ordering Code Bestell-Bezeichnung	Stok Stock Lager		Takım Ölçüleri (mm) Dimension (mm) Abmessung (mm)				Kesici Uç Insert Wendeschneidplatte	Yedek Parçaları / Spare Parts / Ersatzteile			
	R	L	HF=H	B	LF	WF		CDX	Sıkma Vidası Screw Klemmschraube	Pul Stamp Ring	Tork Anahtar Torx Key Torx Innensechskantschlüssel
ADKT-ZCC2-R/L-1010-2-T12-K-S	●	●	10	10	125	10.2	12	Z.BD - 2	4015-M4x11	-	80-T15
ADKT-ZCC2-R/L-1212-2-T12-K-S	●	●	12	12	125	12.2	12				
ADKT-ZCC2-R/L-1616-2-R16-K-S	●	●	16	16	125	16.2	16	Z.FD - 3			
ADKT-ZCC2-R/L-1212-3-T12-K-S	●	●	12	12	125	12.3	12				

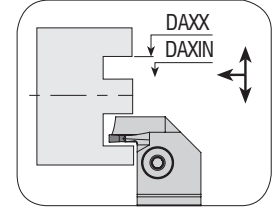
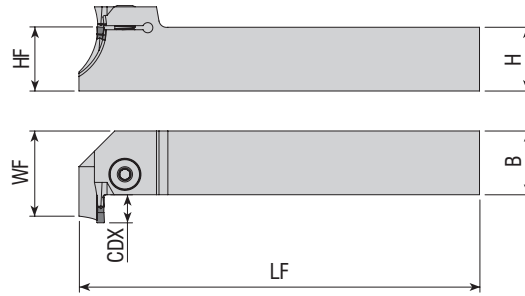

Takım Kodu Ordering Code Bestell-Bezeichnung	Stok Stock Lager		Takım Ölçüleri (mm) Dimension (mm) Abmessung (mm)							Kesici Uç Insert Wendeschneidplatte	Yedek Parçaları / Spare Parts / Ersatzteile			
	R	L	HF=H	B	LF	WF	CDX	DAXIN	DAXX		Sıkma Vidası Screw Klemmschraube	Pul Stamp Ring	Anahtar Allen Key Innensechskantschlüssel	
ALKT-ZCC2-R/L-2525-35-45-3-T10	●	●	25	25	150	36	10	35	45	Z.FD - 3	2004-M8x1x20	-	AAL-05-4	
ALKT-ZCC2-R/L-2525-39-55-3-T10	●	●	25	25	150	36	10	39	55					
ALKT-ZCC2-R/L-2525-35-∞-3-T4	●	●	25	25	150	30	4	35	∞	Z.GD - 4				
ALKT-ZCC2-R/L-2525-40-60-4-T14	●	●	25	25	150	40	14	40	60					
ALKT-ZCC2-R/L-2525-52-80-4-T14	●	○	25	25	150	40	14	52	80	Z.GD - 4				
ALKT-ZCC2-R/L-2525-72-110-4-T14	●	○	25	25	150	40	14	72	110					
ALKT-ZCC2-R/L-2525-100-230-4-T14	●	●	25	25	150	40	14	100	230	Z.GD - 4				
ALKT-ZCC2-R/L-2525-40-∞-4-T4	●	●	25	25	150	30	4	40	∞					

R: Sağ / Right / Rechts L: Sol / Left / Links

● Stokta / In Stock / Auf Lager ○ Stokta Yok / Non Stock Item / Kein Lagerartikel, Lieferzeit auf Anfrage

ZCC Ucuna Uygundur. / Compatible with ZCC Insert. / Kompatibel mit ZCC Wendeplatten.

Sipariş Örneği/Ordering Example/Bestellbeispiel

1 ad./pcs./stück ADKT-ZCC2-R-1010-2-T12-K-S

ZCC Ucuna Uygundur. / Compatible with ZCC Insert. / Kompatibel mit ZCC Wendeplatten.

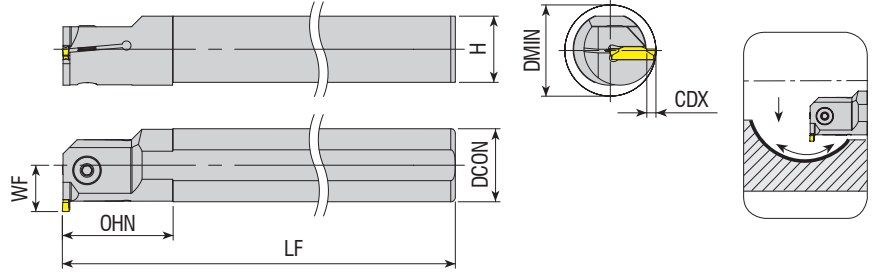

Takım Kodu Ordering Code Bestell-Bezeichnung	Stok Stock Lager		Takım Ölçüleri (mm) Dimension (mm) Abmessung (mm)						Kesici Uç Insert Wendeschneidplatte	Yedek Parçaları / Spare Parts / Ersatzteile		
	R	L	DCON	DMIN	LF	OHN	CDX	H	WF	Sıkma Vidası Screw Klemmschraube	Anahtar Allen Key Innensechskantschlüssel	
AIKT-ZCC2-R/L-16-2-T4	●	○	16	21	150	28	4	14.8	12	Z.BD - 2	2503-M4x10	AAL-03-3
AIKT-ZCC2-R/L-20-3-T5	●	●	20	27	170	30	5	18.3	15	Z.FD - 3	2504-M5x12	AAL-05-4
AIKT-ZCC2-R/L-20-3-T8	●	○	20	29	170	30	8	18.3	18		2504-M5x16	
AIKT-ZCC2-R/L-25-3-T5	●	○	25	31	200	40	5	23	17.5		2504-M5x16	
AIKT-ZCC2-R/L-25-3-T10	●	○	25	36	200	40	10	23	22.5		2004-M8x1x20	
AIKT-ZCC2-R/L-32-3-T6	●	○	32	39	250	50	6	30	22	Z.GD - 4	2004-M8x1x20	AAL-05-4
AIKT-ZCC2-R/L-32-3-T8	●	○	32	41	250	50	8	30	24			
AIKT-ZCC2-R/L-32-3-T13	●	○	32	46	250	50	13	30	29			
AIKT-ZCC2-R/L-40-3-T12	●	○	40	53	300	55	12	37.5	32	Z.HD - 5	2504-M5x16	AAL-05-4
AIKT-ZCC2-R/L-25-4-T6	●	○	25	32	200	40	6	23	18.5			
AIKT-ZCC2-R/L-32-4-T7	●	○	32	40	250	50	7	30	23			
AIKT-ZCC2-R/L-32-4-T8	●	○	32	41	250	50	8	30	24			
AIKT-ZCC2-R/L-32-4-T10	●	○	32	43	250	50	10	30	26	2004-M8x1x20	AAL-05-4	
AIKT-ZCC2-R/L-32-5-T7	●	○	32	40	250	50	7	30	23			
AIKT-ZCC2-R/L-32-5-T8	●	○	32	41	250	50	8	30	24			
AIKT-ZCC2-R/L-40-5-T8	●	○	40	49	300	55	8	37.5	28	2004-M8x1x20	AAL-05-4	
AIKT-ZCC2-R/L-40-5-T10	●	○	40	51	300	55	10	37.5	30			

R: Sağ / Right / Rechts L: Sol / Left / Links

● Stokta / In Stock / Auf Lager ○ Stokta Yok / Non Stock Item / Kein Lagerartikel, Lieferzeit auf Anfrage

ZCC Ucuna Uygundur. / Compatible with ZCC Insert. / Kompatibel mit ZCC Wendeplatten.

Sipariş Örneği/Ordering Example/Bestellbeispiel

1 ad./pcs./stück AIKT-ZCC2-R/L-16-2-T4

ZCC Ucuna Uygundur. / Compatible with ZCC Insert. / Kompatibel mit ZCC Wendeplatten.

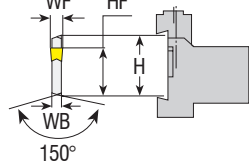
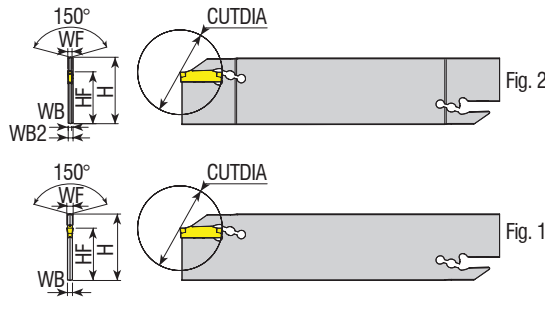
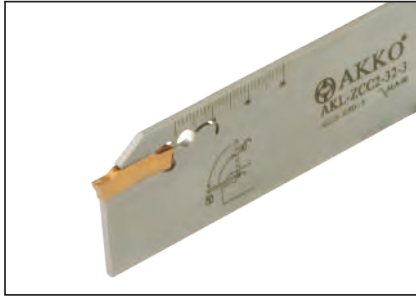

Takım Kodu Ordering Code Bestell-Bezeichnung	Stok Stock Lager		Takım Ölçüleri (mm) Dimension (mm) Abmessung (mm)							Kesici Uç Insert Wendeschneidplatte	Yedek Parçaları / Spare Parts Ersatzteile	
			H	WF	WB2	WB	I	HF	CUTDIA		Fig.	
AKL-ZCC2-32-3	●		32	3	-	2.40	150	25	39	1	Z.FD-3	ALA-02
AKL-ZCC2-32-4	●		32	4	-	3.20	150	25	50.8	1	Z.FD-4	
AKL-ZCC2-32-5	●		32	5	-	4	150	25	50.8	1	Z.FD-5	

Blok bilgileri için sayfa 155'ye gidin. / For block information, go to page 155. / Informationen zu den spannblock finden Sie auf Seite 155.

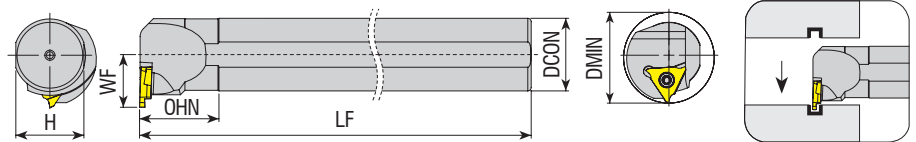

Takım Kodu Ordering Code Bestell-Bezeichnung	Stok Stock Lager		Takım Ölçüleri (mm) Dimension (mm) Abmessung (mm)							Kesici Uç Insert Wendeschneidplatte	Yedek Parçaları / Spare Parts / Ersatzteile	
	R	L	DCON	DMIN	LF	OHN	CDX	H	WF		Sıkma Vidası Screw Klemmschraube	Tork Anahtar Torx Key Torx Innensechskantschlüssel
AIKT-QC11-R/L-20-(0.5-1.8)	●	○	20	16	150	40	-	18.3	11.1	QC11R/L (0.50-1.80)	3008 M2.5x6	82-T08
AIKT-QC16-R/L-20-(0.5-1.8)	○	○	20	25	150	35	-	18.3	13.5	QC16R/L (0.50-1.80)	4015-M3.5x10	80-T15
AIKT-QC16-R/L-20-(0.5-2.5)	●	○	20	25	150	35	-	18.3	13.5	QC16R/L (0.50-2.50)		
AIKT-QC22-R/L-25-(1-2.3)	○	○	25	35	150	35	-	23	18.2	QC22R/L (1.00-2.30)		
AIKT-QC22-R/L-25-(2.5-3.3)	●	○	25	35	150	35	-	23	18.2	QC22R/L (2.50-3.30)	1020 M5x11	80-T20
AIKT-QC22-R/L-25-(3.3-4.8)	●	○	25	35	150	35	-	23	18.2	QC22R/L (3.30-4.80)		
AIKT-QC22-R/L-32-(1-2.3)	○	○	32	45	150	35	-	30	23.2	QC22R/L (1.00-2.30)		

R: Sağ / Right / Rechts L: Sol / Left / Links

● Stokta / In Stock / Auf Lager ○ Stokta Yok / Non Stock Item / Kein Lagerartikel, Lieferzeit auf Anfrage

ZCC Ucuna Uygundur. / Compatible with ZCC Insert. / Kompatibel mit ZCC Wendeplatten.

Sipariş Örneği/Ordering Example/Bestellbeispiel

1 ad./pcs./stück AKL-ZCC2-32-3