

# M-SİSTEM

**M-SİSTEM DIŞ TORNA KATERLERİ**  
M-SYSTEM EXTERNAL TURNING TOOLHOLDERS  
M-SYSTEM AUSSEN - DREHHALTER

*konusulan*  
*the spoken kalite...*  
*quality...*

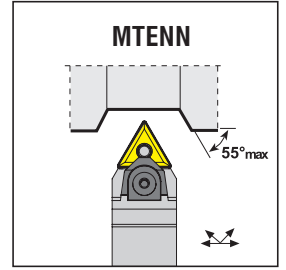

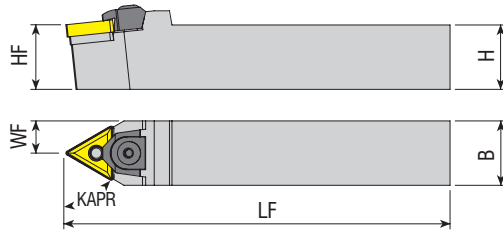
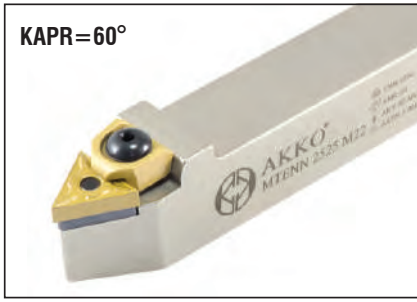

Takım Kodu Ordering Code Bestell-Bezeichnung	Stok Stock Lager		Takım Ölçüleri (mm) Dimension (mm) Abmessung (mm)				Kesici Uç Insert Wendeschneidplatte	Baskı Pabucu Wedge Clamp Spannpratze	Pabuç Vidası Clamp Screw Klemmschraube	Altlık Shim Unterlage	Pim Pin Stift	Segman Ring Feder	Pul Stamp Ring	Anahtar Allen Key Innensechskantschlüssel
	HF=H	B	LF	WF										
MTENN 2020 K16	●		20	20	125	10	TN.. 1604..	AMK-04	AKV-30-M6x22	AATN-2-0002	APM-01	AS-01	ABPL-01	AAL-03-3
MTENN 2525 M16	●		25	25	150	12.5								
MTENN 3232 P16	●		32	32	170	16								
MTENN 2525 M22	●		25	25	150	12.5	TN.. 2204...	AMK-08	AKV-30-M6x22	AATN-3-0015	APM-02	AS-01	ABPL-01	AAL-03-3
MTENN 3232 P22	●		32	32	170	16								
MTENN 4040 S22	●		40	40	250	20								

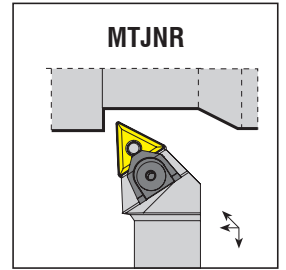
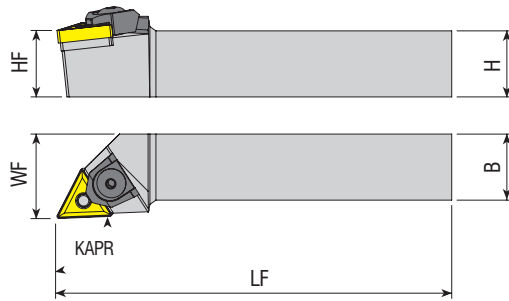
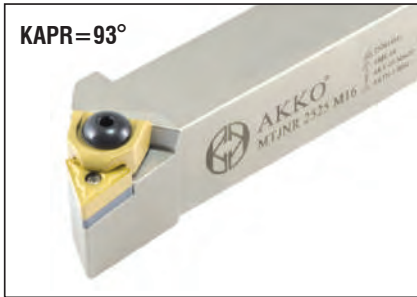

Takım Kodu Ordering Code Bestell-Bezeichnung	Stok Stock Lager		Takım Ölçüleri (mm) Dimension (mm) Abmessung (mm)				Kesici Uç Insert Wendeschneidplatte	Baskı Pabucu Wedge Clamp Spannpratze	Pabuç Vidası Clamp Screw Klemmschraube	Altlık Shim Unterlage	Pim Pin Stift	Segman Ring Feder	Pul Stamp Ring	Anahtar Allen Key Innensechskantschlüssel
	R	L	HF=H	B	LF	WF								
MTJNR/L 2020 K16	●	●	20	20	125	25	TN.. 1604..	AMK-04	AKV-30-M6x22	AATN-2-0002	APM-01	AS-01	ABPL-01	AAL-03-3
MTJNR/L 2525 M16	●	●	25	25	150	32								
MTJNR/L 3232 P16	●	●	32	32	170	40								
MTJNR/L 2525 M22	●	●	25	25	150	32	TN.. 2204...	AMK-08	AKV-30-M6x22	AATN-3-0015	APM-02	AS-01	ABPL-01	AAL-03-3
MTJNR/L 3232 P22	●	●	32	32	170	40								
MTJNR/L 4040 S22	●	●	40	40	250	50								

R: Sağ / Right / Rechts L: Sol / Left / Links

● Stokta / In Stock / Auf Lager ○ Stokta Yok / Non Stock Item / Kein Lagerartikel, Lieferzeit auf Anfrage

Sipariş Örneği/Ordering Example/Bestellbeispiel

1 ad./pcs./stück MTENN 2020 K16

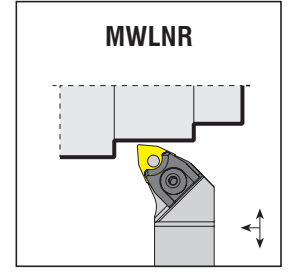
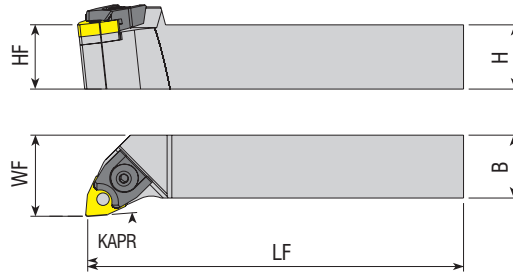

**Takım Kodu**  
**Ordering Code**  
**Bestell-Bezeichnung**

Takım Kodu Ordering Code Bestell-Bezeichnung	Stok Stock Lager		Takım Ölçüleri (mm) Dimension (mm) Abmessung (mm)				Kesici Uç Insert Wendeschneidplatte	Baskı Pabucu Wedge Clamp Spannpratze	Pabuç Vidası Clamp Screw Klemmschraube	Altlık Shim Unterlage	Pim Pin Stift	Segman Ring Feder	Pul Stamp Ring	Anahtar Allen Key Innensechskantschlüssel
	R	L	HF=H	B	LF	WF								
MWLNR/L 1616 H06	●	●	16	16	100	20	WN.. 0604..	AMK-01	AKV-04-M5x17	-	APM-08	-	-	AAL-03-3
MWLNR/L 2020 K06	●	●	20	20	125	25								
MWLNR/L 2525 M06	●	●	25	25	150	32	WN.. 0804..	AMK-05	AKV-03-M6x22	AAWN-3-0001	APM-02	AS-01	ABPL-01	AAL-03-3
MWLNR/L 2020 K08	●	●	20	20	125	25								
MWLNR/L 2525 M08	●	●	25	25	150	32								
MWLNR/L 3232 P08	●	●	32	32	170	40								

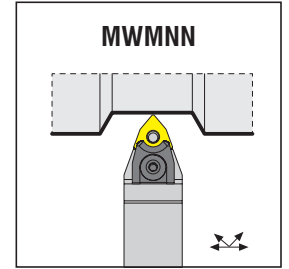
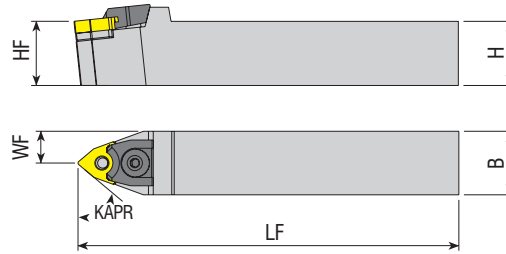

**Takım Kodu**  
**Ordering Code**  
**Bestell-Bezeichnung**

Takım Kodu Ordering Code Bestell-Bezeichnung	Stok Stock Lager		Takım Ölçüleri (mm) Dimension (mm) Abmessung (mm)				Kesici Uç Insert Wendeschneidplatte	Baskı Pabucu Wedge Clamp Spannpratze	Pabuç Vidası Clamp Screw Klemmschraube	Altlık Shim Unterlage	Pim Pin Stift	Segman Ring Feder	Pul Stamp Ring	Anahtar Allen Key Innensechskantschlüssel
	R	L	HF=H	B	LF	WF								
MWMNN 1616 H06	●		16	16	100	8	WN.. 0604..	AMK-01	AKV-04-M5x17	-	APM-08	-	-	AAL-03-3
MWMNN 2020 K06	●		20	20	125	10								
MWMNN 2525 M06	●		25	25	150	12.5	WN.. 0804..	AMK-05	AKV-03-M6x22	AAWN-3-0001	APM-02	AS-01	ABPL-01	AAL-03-3
MWMNN 2020 K08	●		20	20	125	10								
MWMNN 2525 M08	●		25	25	150	12.5								
MWMNN 3232 P08	●		32	32	170	16								

R: Sağ / Right / Rechts L: Sol / Left / Links

● Stokta / In Stock / Auf Lager ○ Stokta Yok / Non Stock Item / Kein Lagerartikel, Lieferzeit auf Anfrage

Sipariş Örneği/Ordering Example/Bestellbeispiel

1 ad./pcs./stück MWLNR 1616 H06