

S-SİSTEM

S-SİSTEM DIŞ TORNA KATERLERİ
S-SYSTEM EXTERNAL TURNING TOOLHOLDERS
S-SYSTEM AUSSEN - DREHHALTER

konusulan
the spoken kalite...
quality...

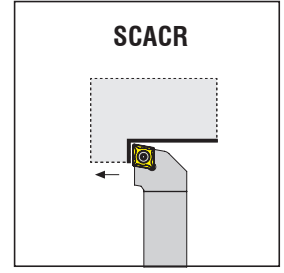

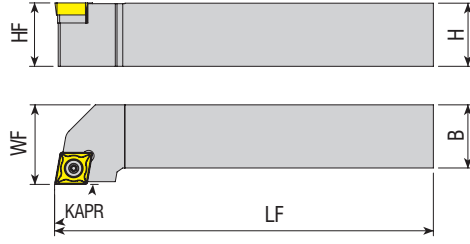

Takım Kodu Ordering Code Bestell-Bezeichnung	Stok Stock Lager		Takım Ölçüleri (mm) Dimension (mm) Abmessung (mm)				Kesici Uç Insert Wendeschneidplatte	Yedek Parçaları / Spare Parts / Ersatzteile			
	R	L	HF=H	B	LF	WF		Sıkma Vidası Screw Klemmschraube	Altlık Shim Unterlage	Altlık Vidası Shim Screw Schraube für Unterlage	Tork Anahtar Torx Key Torx-Schlüssel
SCACR/L 0808 E06	●	●	08	08	70	10	CC.. 0602..	4008-M2.5x6	-	-	82-T08
SCACR/L 1010 E06	●	●	10	10	70	12		4015-M3.5x11	-	-	
SCACR/L 1212 F09	●	●	12	12	80	16	CC.. 09T3..	4015-M3.5x14	AACN-2-0001	AAV-06-M3.5x11	80-T15
SCACR/L 1616 H09	●	●	16	16	100	20					
SCACR/L 2020 K09	●	●	20	20	125	25					
SCACR/L 2020 K12	●	●	20	20	125	25	CC.. 1204..	1020-M4.5x16	AACN-2-0003	AAV-07-M4.5x13	80-T20
SCACR/L 2525 M12	●	●	25	25	150	32					

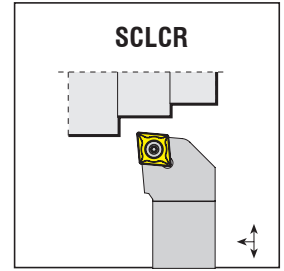
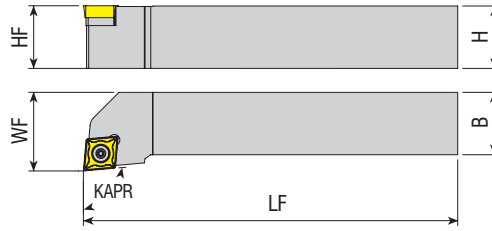
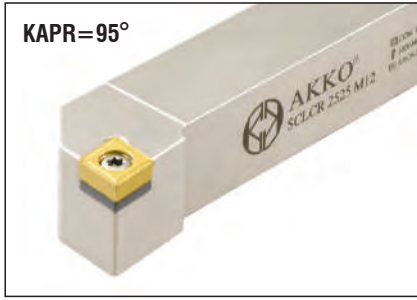

Takım Kodu Ordering Code Bestell-Bezeichnung	Stok Stock Lager		Takım Ölçüleri (mm) Dimension (mm) Abmessung (mm)				Kesici Uç Insert Wendeschneidplatte	Yedek Parçaları / Spare Parts / Ersatzteile			
	R	L	HF=H	B	LF	WF		Sıkma Vidası Screw Klemmschraube	Altlık Shim Unterlage	Altlık Vidası Shim Screw Schraube für Unterlage	Tork Anahtar Torx Key Torx-Schlüssel
SCLCR/L 0808 E06	●	●	08	08	70	10	CC.. 0602..	4008-M2.5x6	-	-	82-T08
SCLCR/L 1010 E06	●	○	10	10	70	12		4015-M3.5x9	-	-	
SCLCR/L 1212 F06	●	●	12	12	80	16	CC.. 09T3..	4015-M3.5x11	-	-	80-T15
SCLCR/L 1010 E09	●	●	10	10	70	12					
SCLCR/L 1212 F09	●	●	12	12	80	16					
new SCLCR/L 1212 M09	●	●	12	12	150	16	CC.. 1204..	4015-M3.5x14	AACN-2-0001	AAV-06-M3.5x11	80-T15
SCLCR/L 1616 H09	●	●	16	16	100	20					
SCLCR/L 2020 K09	●	●	20	20	125	25					
SCLCR/L 2525 M09	●	●	25	25	150	32	CC.. 1204..	1020-M5x11	AACN-2-0003	AAV-07-M4.5x13	80-T20
SCLCR/L 1616 H12	●	○	16	16	100	20		1020-M4.5x16			
SCLCR/L 2020 K12	●	●	20	20	125	25					
SCLCR/L 2525 M12	●	●	25	25	150	32					

R: Sağ / Right / Rechts L: Sol / Left / Links
● Stokta / In Stock / Auf Lager ○ Stokta Yok / Non Stock Item / Kein Lagerartikel, Lieferzeit auf Anfrage

Sipariş Örneği/Ordering Example/Bestellbeispiel
1 ad./pcs./stück SCACR 0808 E06

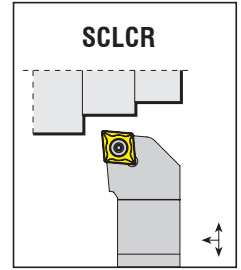
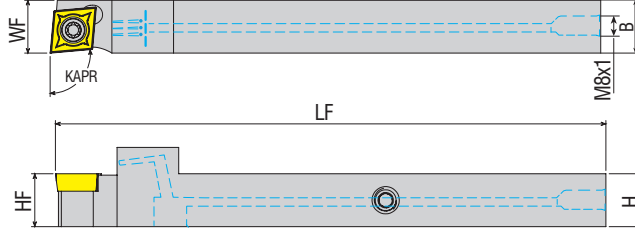

Takım Kodu Ordering Code Bestell-Bezeichnung	Stok Stock Lager		Takım Ölçüleri (mm) Dimension (mm) Abmessung (mm)				Kesici Uç Insert Wendeschneidplatte	Yedek Parçaları / Spare Parts / Ersatzteile					
	R	L	HF=H	B	LF	WF		Sıkma Vidası Screw Klemmschraube	Altılık Shim Unterlage	Altılık Vidası Shim Screw Schraube für Unterlage	Sızdırmaz Vidâ Threaded Pin Gewindestift	Anahtar Allen Key Innensechskantschlüssel	Tork Anahtar Torx Key Torx-Schlüssel
SCLCR/L 1212 K09-SHC	●	○	12	12	125	12	CC.. 09T3..	4015-M3.5x11	-	-	2703-M6X4	AAL-03-3	80-T15
SCLCR/L 1616 K09-SHC	●	○	16	16	125	16					2704-M8X1X5	AAL-05-4	

ISO Ucuna Uygundur. / Compatible with ISO Insert. / Kompatibel mit ISO Wendepfatten.

S-SİSTEM DIŞ TORNA KATERLERİ
S-SYSTEM EXTERNAL TURNING TOOLHOLDERS
S-SYSTEM AUSSEN - DREHHALTER

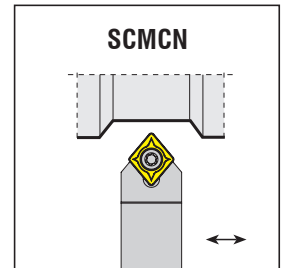
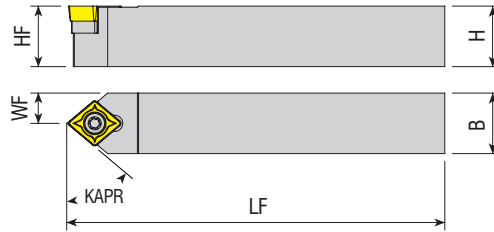
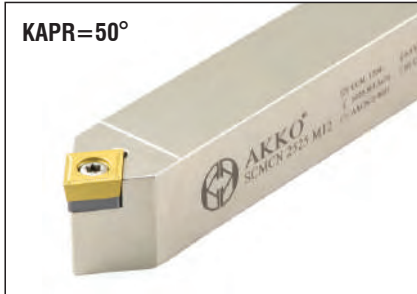

Takım Kodu Ordering Code Bestell-Bezeichnung	Stok Stock Lager		Takım Ölçüleri (mm) Dimension (mm) Abmessung (mm)				Kesici Uç Insert Wendeschneidplatte	Yedek Parçaları / Spare Parts / Ersatzteile				
	R	L	HF=H	B	LF	WF		Sıkma Vidası Screw Klemmschraube	Altılık Shim Unterlage	Altılık Vidası Shim Screw Schraube für Unterlage	Tork Anahtar Torx Key Torx-Schlüssel	
SCMCN 0808 E06	●		08	08	70	04	CC.. 0602..	4008-M2.5x6	-	-	82-T08	
SCMCN 1010 E06	●		10	10	70	05						
SCMCN 1212 F06	●		12	12	80	06						
SCMCN 1212 F09	●		12	12	80	06	CC.. 09T3..	4015-M3.5x11	-	-	80-T15	
SCMCN 1616 H09	●		16	16	100	08						4015-M3.5x14
SCMCN 2020 K12	●		20	20	125	10	CC.. 1204..	1020-M4.5x16	AACN-2-0003	AAV-07-M4.5x13	80-T20	
SCMCN 2525 M12	●		25	25	150	12.5						

R: Sağ / Right / Rechts L: Sol / Left / Links

● Stokta / In Stock / Auf Lager ○ Stokta Yok / Non Stock Item / Kein Lagerartikel, Lieferzeit auf Anfrage

Sipariş Örneği/Ordering Example/Bestellbeispiel

1 ad./pcs./stück SCLCR/L 1212 K09-SHC

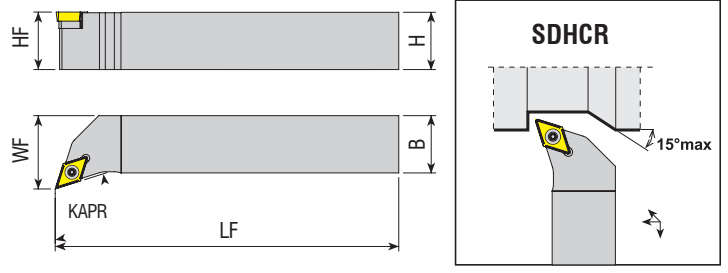
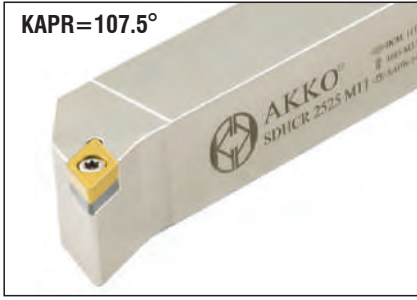

Takım Kodu
Ordering Code
Bestell-Bezeichnung

Stok
Stock
Lager

Takım Ölçüleri (mm)
Dimension (mm)
Abmessung (mm)

Kesici Uç
Insert
Wendeschneidplatte

Yedek Parçaları / Spare Parts / Ersatzteile

Sıkma Vidası
Screw
Klemmschraube

Altlık
Shim
Unterlage

Altlık Vidası
Shim Screw
Schraube für Unterlage

Tork Anahtar
Torx Key
Torx-Schlüssel

R L HF=H B LF WF

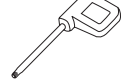
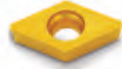

SDHCR/L 0808 E07
SDHCR/L 1010 E07
SDHCR/L 1212 F07
SDHCR/L 1616 H07
SDHCR/L 1616 H11
SDHCR/L 2020 K11
SDHCR/L 2525 M11
SDHCR/L 3232 P11

● ● 08 08 70 11
● ● 10 10 70 12
● ● 12 12 80 16
● ● 16 16 100 20
● ● 16 16 100 20
● ● 20 20 125 25
● ● 25 25 150 32
● ● 32 32 170 40

DC.. 0702..

4008-M2.5x6

-

-

82-T08

DC.. 11T3..

4015-M3.5x14

AADN-2-0001

AAV-06-M3.5x11

80-T15

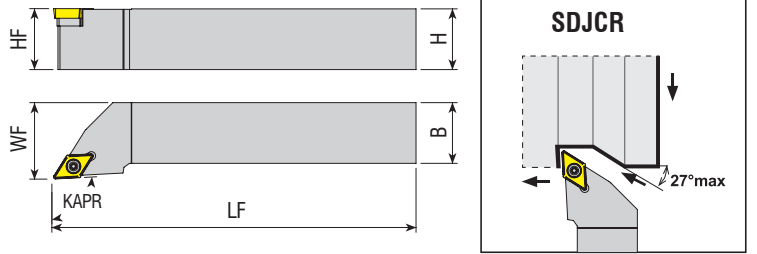

Takım Kodu
Ordering Code
Bestell-Bezeichnung

Stok
Stock
Lager

Takım Ölçüleri (mm)
Dimension (mm)
Abmessung (mm)

Kesici Uç
Insert
Wendeschneidplatte

Yedek Parçaları / Spare Parts / Ersatzteile

Sıkma Vidası
Screw
Klemmschraube

Altlık
Shim
Unterlage

Altlık Vidası
Shim Screw
Schraube für Unterlage

Tork Anahtar
Torx Key
Torx-Schlüssel

HF=H B LF WF

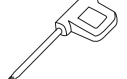

SDJCR/L 0808 E07
SDJCR/L 1010 E07
SDJCR/L 1212 F07
SDJCR/L 1616 H07
SDJCR/L 1212 F11
SDJCR/L 1616 H11
SDJCR/L 2020 K11
SDJCR/L 2525 M11
SDJCR/L 3232 P11

● ● 08 08 70 10
● ● 10 10 70 12
● ● 12 12 80 16
● ● 16 16 100 20
● ● 12 12 80 16
● ● 16 16 100 20
● ● 20 20 125 25
● ● 25 25 150 32
● ● 32 32 170 40

DC.. 0702..

4008-M2.5x6

-

-

82-T08

DC.. 11T3..

4015-M3.5x14

AADN-2-0001

AAV-06-M3.5x11

80-T15

R: Sağ / Right / Rechts L: Sol / Left / Links

● Stokta / In Stock / Auf Lager ○ Stokta Yok / Non Stock Item / Kein Lagerartikel, Lieferzeit auf Anfrage

Sipariş Örneği / Ordering Example / Bestellbeispiel

1 ad./pcs./stück SDHCR 0808 E07

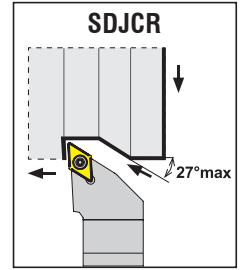
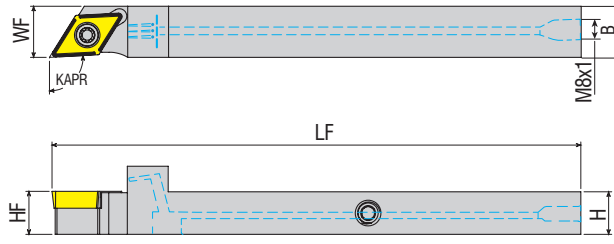

Takım Kodu Ordering Code Bestell-Bezeichnung	Stok Stock Lager		Takım Ölçüleri (mm) Dimension (mm) Abmessung (mm)				Kesici Uç Insert Wendeschneidplatte	Sıkma Vidası Screw Klemmschraube	Altık Shim Unterlage	Altık Vidası Shim Screw Schraube für Unterlage	Sızdırmaz Vida Threaded Pin Gewindestift	Anahtar Allen Key Inmenschschlüssel	Tork Anahtar Torx Key Torx-Schlüssel
	R	L	HF=H	B	LF	WF							
SDJCR/L 0810 G07-SHC	●	○	8	10	90	10	DC.. 0702..	4008-M2.5x6					82-T08
SDJCR/L 1010 K07-SHC	●	○	10	10	125	10							
SDJCR/L 1012 K11-SHC	●	○	10	12	125	12	DC.. 11T3..	4015-M3.5x14	-	-	2703-M6X4	AAL-03-3	80-T15
SDJCR/L 1212 K11-SHC	●	○	12	12	125	12							
SDJCR/L 1616 K11-SHC	●	○	16	16	125	16							

ISO Ucuna Uygundur. / Compatible with ISO Insert. / Kompatibel mit ISO Wendepfatten.

S-SİSTEM DIŞ TORNA KATERLERİ
S-SYSTEM EXTERNAL TURNING TOOLHOLDERS
S-SYSTEM AUSSEN - DREHHALTER

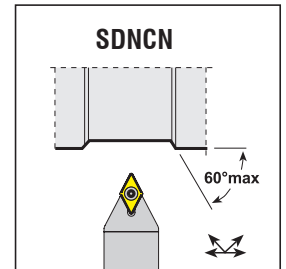
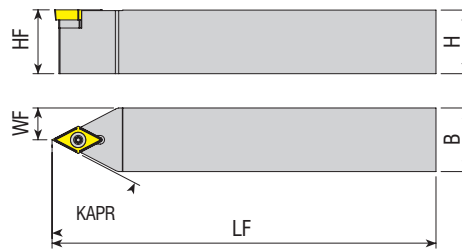
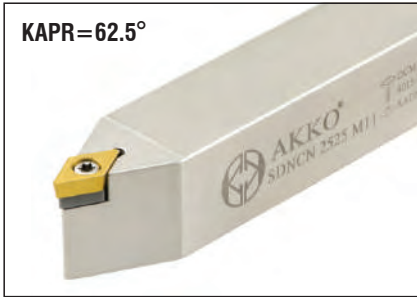

Takım Kodu Ordering Code Bestell-Bezeichnung	Stok Stock Lager		Takım Ölçüleri (mm) Dimension (mm) Abmessung (mm)				Kesici Uç Insert Wendeschneidplatte	Sıkma Vidası Screw Klemmschraube	Altık Shim Unterlage	Altık Vidası Shim Screw Schraube für Unterlage	Tork Anahtar Torx Key Torx-Schlüssel
			HF=H	B	LF	WF					
SDNCN 0808 E07	●		08	08	70	4	DC.. 0702..	4008-M2.5x6	-	-	82-T08
SDNCN 1010 E07	●		10	10	70	5					
SDNCN 1212 F07	●		12	12	80	6					
SDNCN 1616 H07	●		16	16	100	8					
SDNCN 1616 H11	●		16	16	100	8	DC.. 11T3..	4015-M3.5x14	AADN-2-0001	AAV-06-M3.5x11	80-T15
SDNCN 2020 K11	●		20	20	125	10					
SDNCN 2525 M11	●		25	25	150	12.5					
SDNCN 3232 P11	●		32	32	170	16					

R: Sağ / Right / Rechts L: Sol / Left / Links

● Stokta / In Stock / Auf Lager ○ Stokta Yok / Non Stock Item / Kein Lagerartikel, Lieferzeit auf Anfrage

Sipariş Örneği/Ordering Example/Bestellbeispiel
1 ad./pcs./stück SDJCR/L 0810 G07-SHC

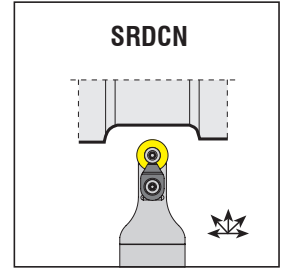
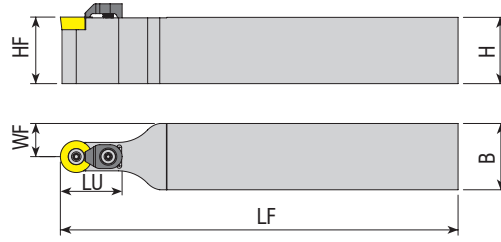
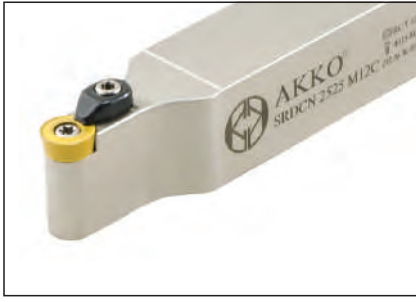

Takım Kodu Ordering Code Bestell-Bezeichnung	Stok Stock Lager	Takım Ölçüleri (mm) Dimension (mm) Abmessung (mm)					Kesici Uç Insert Wendeschneidplatte	Yedek Parçaları / Spare Parts / Ersatzteile							
		HF=H	B	LF	LU	WF		Sıkma Vidası Screw Klemmschraube	Altlık Shim Unterlage	Altlık Vidası Shim Screw Schraube für Unterlage	Baskı Parçası Wedge Clamp Spannpratze	Baskı Vidası Clamp Screw Klemmschraube	Tork Anahtar Torx Key Torx-Schlüssel		
SRDCN 1616 H06	●	16	16	100	15	8									
SRDCN 2020 K06	●	20	20	125	17	10	RC.. 0602..	3008-M2.5x6	-	-	-	-			
SRDCN 2525 M06	●	25	25	150	17	12.5									
SRDCN 1616 H08C	●	16	16	100	15	8									82-T08
SRDCN 2020 K08C	●	20	20	125	20	10	RC.. 0803..	3008-M3x8	-	-					
SRDCN 2525 M08C	●	25	25	150	20	12.5									
SRDCN 1616 H10C	●	16	16	100	20	8					ACK-15	4015-M3.5x11			
SRDCN 2020 K10C	●	20	20	125	20	10	RC.. 10T3..	4015-M3.5x11	-	-					
SRDCN 2525 M10C	●	25	25	150	20	12.5									
SRDCN 3232 P10C	●	32	32	170	20	16									
SRDCN 2020 K12C	●	20	20	125	22	10									80-T15
SRDCN 2525 M12C	●	25	25	150	22	12.5	RC.. 1204..	4015-M3.5x11	-	-					
SRDCN 3232 P12C	●	32	32	170	22	16									
SRDCN 2525 M16C	●	25	25	150	32	12.5	RC.. 1605..	1020-M5x11	-	-					
SRDCN 3232 P16C	●	32	32	170	35	16					ACK-05	4015-M4x11			
SRDCN 2525 M20C	●	25	25	150	32	12.5	RC.. 2006..	1420-M6x16	-	-					80-T20
SRDCN 3232 P20C	●	32	32	170	40	16									
SRDCN 3232 P25C	●	32	32	170	40	16	RC.. 2507..	1520-M6x16	-	-	ACK-09	AAV-05-M6x15			
SRDCN 3232 P32C	●	32	32	170	45	16	RC.. 3209..	1904-M8x1x20	-	-					AAL-05-4

R: Sağ / Right / Rechts L: Sol / Left / Links

● Stokta / In Stock / Auf Lager ○ Stokta Yok / Non Stock Item / Kein Lagerartikel, Lieferzeit auf Anfrage

Sipariş Örneği/Ordering Example/Bestellbeispiel

1 ad./pcs./stück SRDCN 1616 H06



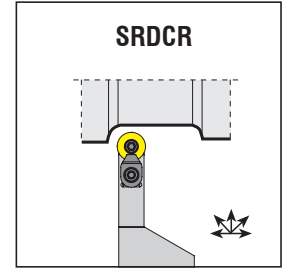
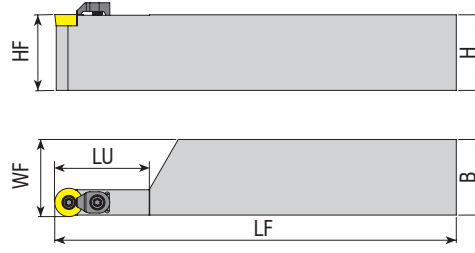

Takım Kodu
Ordering Code
Bestell-Bezeichnung

Stok Stock Lager	Takım Ölçüleri (mm) Dimension (mm) Abmessung (mm)						Kesici Uç Insert Wendeschneidplatte	Yedek Parçaları / Spare Parts / Ersatzteile						
	R	L	HF=H	B	LF	LU		WF	Sıkma Vidası Screw Klemmschraube	Altlık Shim Unterlage	Altlık Vidası Shim Screw Schraube für Unterlage	Baskı Parçası Wedge Clamp Spannpratze	Baskı Vidası Clamp Screw Klemmschraube	Tork Anahtar Torx Key Torx-Schlüssel
SRDCR/L 3232 T06	●	●	32	32	300	20	32.35	RC.. 0602..	3008-M2.5x6	-	-	-	-	82-T08
SRDCR/L 3232 P12C	●	●	32	32	170	40	32.65	RC.. 1204..	4015-M3.5x11	-	-	ACK-05	4015-M4x11	80-T15
new SRDCR/L 3232 P16C	●	○	32	32	170	40	32.85	RC.. 1605..	1020-M5x11	-	-	-	-	80-T20

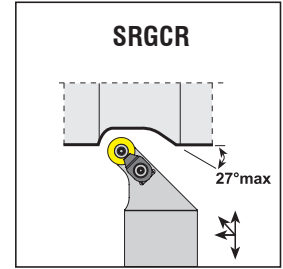
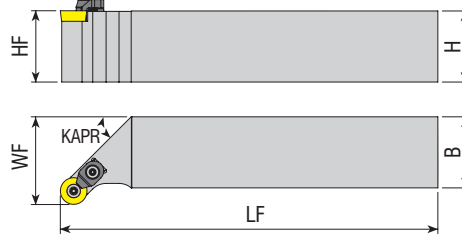

Takım Kodu
Ordering Code
Bestell-Bezeichnung

Stok Stock Lager	Takım Ölçüleri (mm) Dimension (mm) Abmessung (mm)						Kesici Uç Insert Wendeschneidplatte	Yedek Parçaları / Spare Parts / Ersatzteile						
	R	L	HF=H	B	LF	WF		Sıkma Vidası Screw Klemmschraube	Altlık Shim Unterlage	Altlık Vidası Shim Screw Schraube für Unterlage	Baskı Parçası Wedge Clamp Spannpratze	Baskı Vidası Clamp Screw Klemmschraube	Tork Anahtar Torx Key Torx-Schlüssel	
SRGCR/L 1616 H06	●	●	16	16	100	20	RC.. 0602..	3008-M2.5x6	-	-	-	-	82-T08	
SRGCR/L 2020 K06	●	●	20	20	125	25								
SRGCR/L 1616 H08C	●	●	16	16	100	20	RC.. 0803..	3008-M3x8	-	-	-	-	82-T08	
SRGCR/L 2020 K08C	●	●	20	20	125	25								
SRGCR/L 2525 M08C	●	●	25	25	150	32	RC.. 10T3..	4015-M3.5x11	-	-	ACK-15	4015-M3.5x11	80-T15	
SRGCR/L 1616 H10C	●	●	16	16	100	20								
SRGCR/L 2020 K10C	●	●	20	20	125	25								
SRGCR/L 2525 M10C	●	●	25	25	150	32								
SRGCR/L 3232 P10C	●	●	32	32	170	40	RC.. 1204..	4015-M3.5x11	-	-	ACK-05	4015-M4x11	80-T15	
SRGCR/L 2020 K12C	●	●	20	20	125	25								
SRGCR/L 2525 M12C	●	●	25	25	150	32								
SRGCR/L 3232 P12C	●	●	32	32	170	40								

R: Sağ / Right / Rechts L: Sol / Left / Links

● Stokta / In Stock / Auf Lager ○ Stokta Yok / Non Stock Item / Kein Lagerartikel, Lieferzeit auf Anfrage

Sipariş Örneği/Ordering Example/Bestellbeispiel

1 ad./pcs./stück SRDCR 3232 T06

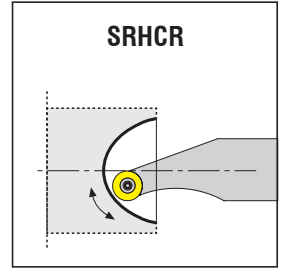
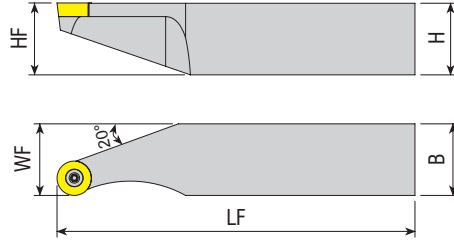

Takım Kodu
Ordering Code
Bestell-Bezeichnung

Stok Stock Lager	Takım Ölçüleri (mm) Dimension (mm) Abmessung (mm)						Kesici Uç Insert Wendeschneidplatte	Yedek Parçaları / Spare Parts / Ersatzteile				
	R	L	HF=H	B	LF	WF		MIN R	Sıkma Vidası Screw Klemmschraube	Altlık Shim Unterlage	Altlık Vidası Shim Screw Schraube für Unterlage	Tork Anahtar Torx Key Torx-Schlüssel
	●	○	25	25	125	25	32.5					
SRHCR/L 2525 K06	●	○	25	25	125	25	32.5	RC.. 0602..	3008-M2.5x6	-	-	82-T08
SRHCR/L 2525 K08	●	●	25	25	125	25	32.5	RC.. 0803..	3008-M3x8	-	-	82-T08
SRHCR/L 2525 K10	●	●	25	25	125	25	36	RC.. 10T3..	4015-M3.5x11	-	-	80-T15
SRHCR/L 2525 K12	●	●	25	25	125	25	40	RC.. 1204..	4015-M3.5x11	-	-	80-T15
SRHCR/L 2525 K16	●	●	25	25	125	25	47.5	RC.. 1606..	1020-M5x11	-	-	80-T20

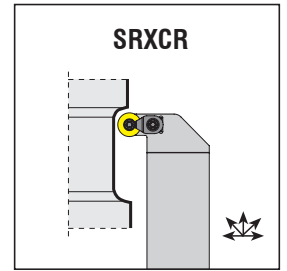
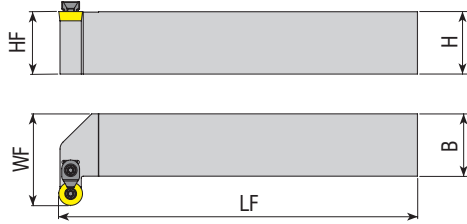

Takım Kodu
Ordering Code
Bestell-Bezeichnung

Stok Stock Lager	Takım Ölçüleri (mm) Dimension (mm) Abmessung (mm)						Kesici Uç Insert Wendeschneidplatte	Sıkma Vidası Screw Klemmschraube	Altlık Shim Unterlage	Altlık Vidası Shim Screw Schraube für Unterlage	Baskı Parçası Wedge Clamp Spannpratze		Baskı Vidası Clamp Screw Klemmschraube	Tork Anahtar Torx Key Torx-Schlüssel
	R	L	HF=H	B	LF	WF					ACK	Clamp Screw		
	●	●	32	32	220	47								
SRXCR/L 3232 X08C	●	●	32	32	220	47	RC.. 0803..	3008-M3x8	-	-	ACK-15	4015-M3.5x11	82-T08	
SRXCR/L 3232 X10C	●	●	32	32	220	47	RC.. 10T3..	4015-M3.5x11	-	-	ACK-05	4015-M4x11	80-T15	
SRXCR/L 3232 X12C	●	●	32	32	220	47	RC.. 1204..	4015-M3.5x11	-	-	ACK-05	4015-M4x11	80-T15	

R: Sağ / Right / Rechts L: Sol / Left / Links

● Stokta / In Stock / Auf Lager ○ Stokta Yok / Non Stock Item / Kein Lagerartikel, Lieferzeit auf Anfrage

Sipariş Örneği/Ordering Example/Bestellbeispiel

1 ad./pcs./stück SRHCR 2525 K06

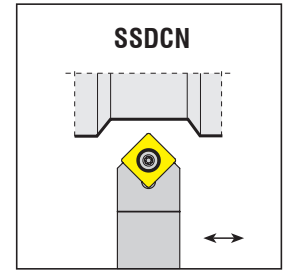
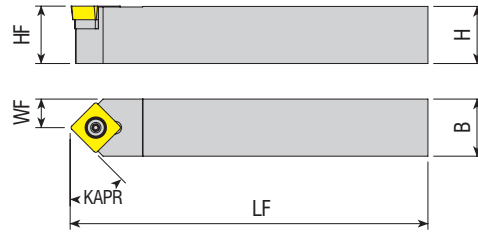

Takım Kodu Ordering Code Bestell-Bezeichnung	Stok Stock Lager		Takım Ölçüleri (mm) Dimension (mm) Abmessung (mm)				Kesici Uç Insert Wendeschneidplatte	Yedek Parçaları / Spare Parts / Ersatzteile			
	R	L	HF=H	B	LF	WF		Sıkma Vidası Screw Klemmschraube	Altlık Shim Unterlage	Altlık Vidası Shim Screw Schraube für Unterlage	Tork Anahtar Torx Key Torx-Schlüssel
SSDCN 1212 F09	●		12	12	80	6	SC.. 09T3..	4015-M3.5x11	-	-	80-T15
SSDCN 1616 H09	●		16	16	100	8		4015-M3.5x14	AASN-2-0001	AAV-06-M3.5x11	
SSDCN 2020 K09	●		20	20	125	10		4020-M4.5x12		AAV-10-M4.5x8	
SSDCN 1616 H12	●		16	16	100	8	SC.. 1204..	1020-M4.5x16	AASN-2-0004	AAV-07-M4.5x13	80-T20
SSDCN 2020 K12	●		20	20	125	10					
SSDCN 2525 M12	●		25	25	150	12.5					

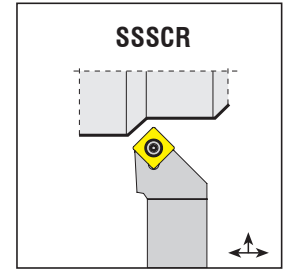
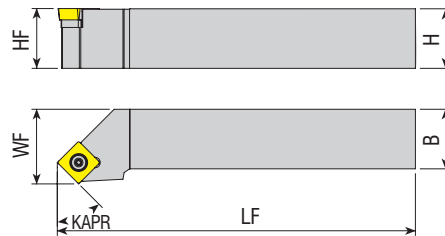

Takım Kodu Ordering Code Bestell-Bezeichnung	Stok Stock Lager		Takım Ölçüleri (mm) Dimension (mm) Abmessung (mm)				Kesici Uç Insert Wendeschneidplatte	Yedek Parçaları / Spare Parts / Ersatzteile			
	R	L	HF=H	B	LF	WF		Sıkma Vidası Screw Klemmschraube	Altlık Shim Unterlage	Altlık Vidası Shim Screw Schraube für Unterlage	Tork Anahtar Torx Key Torx-Schlüssel
SSSCR/L 1212 F09	●	●	12	12	80	16	SC.. 09T3..	4015-M3.5x11	-	-	80-T15
SSSCR/L 1616 H09	●	●	16	16	100	20		4015-M3.5x14	AASN-2-0001	AAV-06-M3.5x11	
SSSCR/L 2020 K09	●	●	20	20	125	25		4020-M4.5x12		AAV-10-M4.5x8	
SSSCR/L 1616 H12	●	●	16	16	100	20	SC.. 1204..	1020-M4.5x16	AASN-2-0004	AAV-07-M4.5x13	80-T20
SSSCR/L 2020 K12	●	●	20	20	125	25					
SSSCR/L 2525 M12	●	●	25	25	150	32					

R: Sağ / Right / Rechts L: Sol / Left / Links

● Stokta / In Stock / Auf Lager ○ Stokta Yok / Non Stock Item / Kein Lagerartikel, Lieferzeit auf Anfrage

Sipariş Örneği / Ordering Example / Bestellbeispiel

1 ad./pcs./stück SSDCN 1212 F09

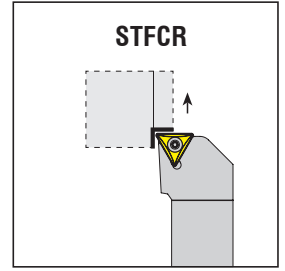
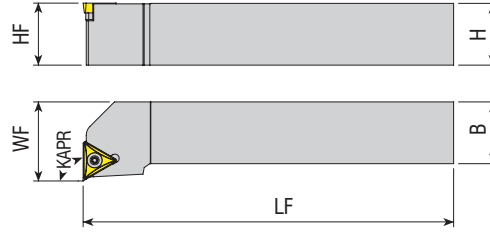

Takım Kodu
Ordering Code
Bestell-Bezeichnung

Stok Stock Lager		Takım Ölçüleri (mm) Dimension (mm) Abmessung (mm)				Kesici Uç Insert Wendeschneidplatte	Sıkma Vidası Screw Klemmschraube	Altlık Shim Unterlage	Altlık Vidası Shim Screw Schraube für Unterlage	Tork Anahtar Torx Key Torx-Schlüssel
R	L	HF=H	B	LF	WF					
○	○	08	08	70	10		3007-M2.2x4.6			82-T07
●	●	10	10	70	12	TC.. 1102..	4008-M2.5x6	-	-	82-T08
●	●	12	12	80	16					
●	●	16	16	100	20	TC.. 16T3..	4015-M3.5x14	AATN-2-0001	AAV-06-M3.5x11	80-T15
●	●	16	16	100	20					
●	●	20	20	125	25					
●	●	25	25	150	32					
●	●	32	32	170	40					

Yedek Parçaları / Spare Parts / Ersatzteile

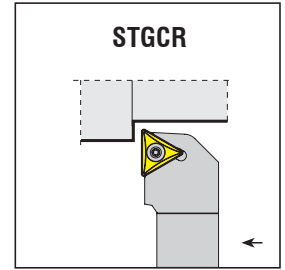
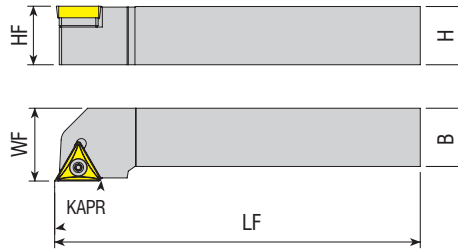

Takım Kodu
Ordering Code
Bestell-Bezeichnung

Stok Stock Lager		Takım Ölçüleri (mm) Dimension (mm) Abmessung (mm)				Kesici Uç Insert Wendeschneidplatte	Sıkma Vidası Screw Klemmschraube	Altlık Shim Unterlage	Altlık Vidası Shim Screw Schraube für Unterlage	Tork Anahtar Torx Key Torx-Schlüssel
R	L	HF=H	B	LF	WF					
●	●	08	08	70	10		3007-M2.2x4.6			82-T07
●	●	10	10	70	12	TC.. 1102..	4008-M2.5x6	-	-	82-T08
●	●	12	12	80	16					
●	●	16	16	100	20	TC.. 16T3..	4015-M3.5x14	AATN-2-0001	AAV-06-M3.5x11	80-T15
●	●	16	16	100	20					
●	●	20	20	125	25					
●	●	25	25	150	32					
●	●	32	32	170	40					

Yedek Parçaları / Spare Parts / Ersatzteile

R: Sağ / Right / Rechts L: Sol / Left / Links
● Stokta / In Stock / Auf Lager ○ Stokta Yok / Non Stock Item / Kein Lagerartikel, Lieferzeit auf Anfrage

Sipariş Örneği/Ordering Example/Bestellbeispiel
1 ad./pcs./stück STFCCR 0808 E09

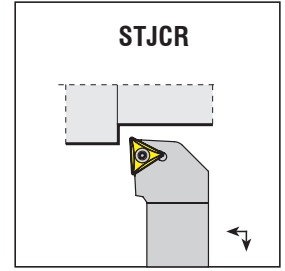
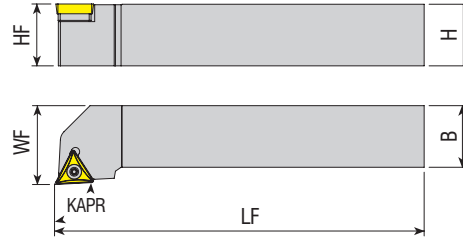
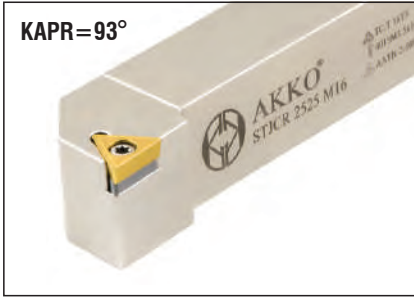

Takım Kodu
Ordering Code
Bestell-Bezeichnung

Stok Stock Lager		Takım Ölçüleri (mm) Dimension (mm) Abmessung (mm)				Kesici Uç Insert Wendeschneidplatte	Sıkma Vidası Screw Klemmschraube	Altlık Shim Unterlage	Altlık Vidası Shim Screw Schraube für Unterlage	Tork Anahtar Torx Key Torx-Schlüssel
R	L	HF=H	B	LF	WF					
●	●	08	08	70	10	TC.. 0902..	3007-M2.2x4.6		82-T07	
●	●	10	10	70	12					
●	●	12	12	80	16	TC.. 1102..	4008-M2.5x6	-	82-T08	
●	●	16	16	100	20					
●	●	16	16	100	20	TC.. 16T3..	4015-M3.5x14	AATN-2-0001	AAV-06-M3.5x11	
●	●	20	20	125	25					
●	●	25	25	150	32					
●	●	32	32	170	40					

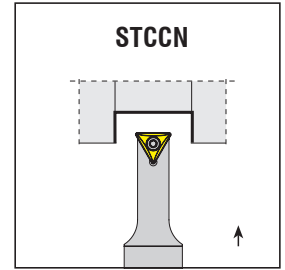
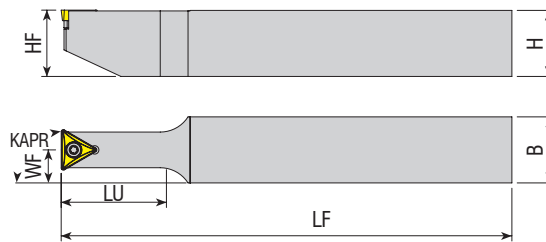

Takım Kodu
Ordering Code
Bestell-Bezeichnung

Stok Stock Lager		Takım Ölçüleri (mm) Dimension (mm) Abmessung (mm)				Kesici Uç Insert Wendeschneidplatte	Sıkma Vidası Screw Klemmschraube	Altlık Shim Unterlage	Altlık Vidası Shim Screw Schraube für Unterlage	Tork Anahtar Torx Key Torx-Schlüssel
R	L	HF=H	B	LF	WF	LU				
●		20	20	140	10	50	TC.. 1102..	4008-M2.5x6	-	82-T08
●		16	16	125	8	24				
●		20	20	150	10	30	TC.. 16T3..	4015-M3.5x14	AATN-2-0001	AAV-06-M3.5x11
●		25	25	170	12.5	37.5				
●		32	32	200	16	48				
●		25	25	170	12.5	80				
●		25	25	170	12.5	80	TC.. 2204..	4020-M4.5x12	-	80-T20

R: Sağ / Right / Rechts L: Sol / Left / Links

● Stokta / In Stock / Auf Lager ○ Stokta Yok / Non Stock Item / Kein Lagerartikel, Lieferzeit auf Anfrage

Sipariş Örneği/Ordering Example/Bestellbeispiel

1 ad./pcs./stück STJCR 0808 E09

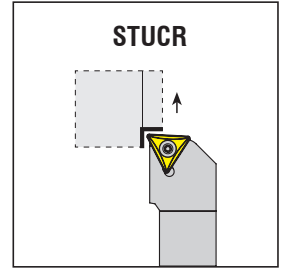
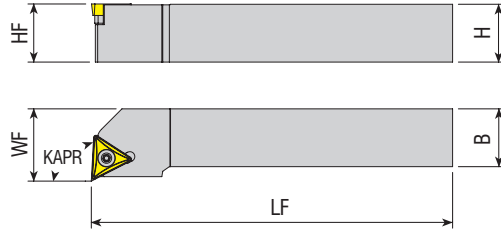
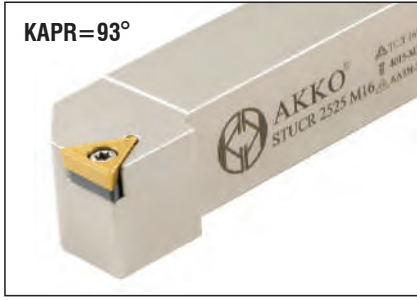

Takım Kodu
Ordering Code
Bestell-Bezeichnung

Stok Stock Lager		Takım Ölçüleri (mm) Dimension (mm) Abmessung (mm)				Kesici Uç Insert Wendeschneidplatte	Sıkma Vidası Screw Klemmschraube	Altlık Shim Unterlage	Altlık Vidası Shim Screw Schraube für Unterlage	Tork Anahtar Torx Key Torx-Schlüssel
R	L	HF=H	B	LF	WF					
●	●	08	08	70	10		3007-M2.2x4.6			82-T07
●	●	10	10	70	12					
●	●	12	12	80	16		4008-M2.5x6			82-T08
●	●	16	16	100	20					
○	○	16	16	100	20		4015-M3.5x14	AATN-2-0001	AAV-06-M3.5x11	80-T15
●	●	20	20	125	25					
●	●	25	25	150	32					
●	●	32	32	170	40					

Yedek Parçaları / Spare Parts / Ersatzteile

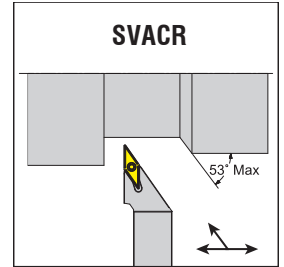
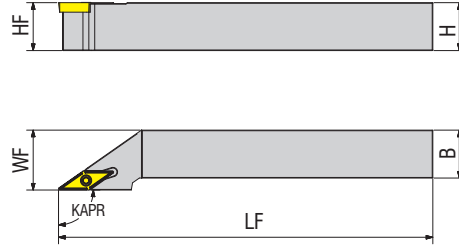

Takım Kodu
Ordering Code
Bestell-Bezeichnung

Stok Stock Lager		Takım Ölçüleri (mm) Dimension (mm) Abmessung (mm)				Kesici Uç Insert Wendeschneidplatte	Sıkma Vidası Screw Klemmschraube	Altlık Shim Unterlage	Altlık Vidası Shim Screw Schraube für Unterlage	Tork Anahtar Torx Key Torx-Schlüssel
R	L	HF=H	B	LF	WF					
●	●	12	12	125	16		4008-M2.5x6			82-T08
●	●	16	16	125	20					
●	●	20	20	125	25					

Yedek Parçaları / Spare Parts / Ersatzteile

R: Sağ / Right / Rechts L: Sol / Left / Links
● Stokta / In Stock / Auf Lager ○ Stokta Yok / Non Stock Item / Kein Lagerartikel, Lieferzeit auf Anfrage

Sipariş Örneği/Ordering Example/Bestellbeispiel
1 ad./pcs./stück STUCR 0808 E09

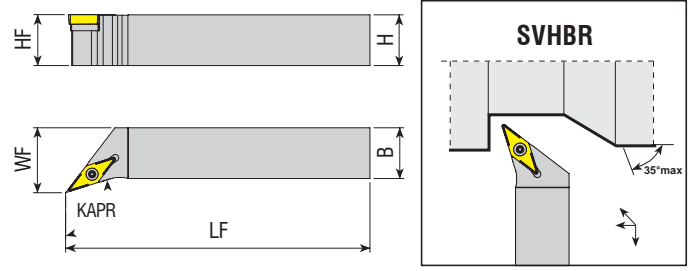
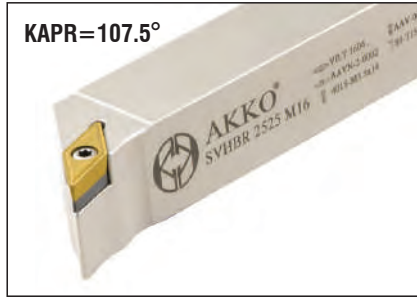

Takım Kodu
Ordering Code
Bestell-Bezeichnung

Stok Stock Lager	Takım Ölçüleri (mm) Dimension (mm) Abmessung (mm)					Kesici Uç Insert Wendeschneidplatte	Yedek Parçaları / Spare Parts / Ersatzteile			
	R	L	HF=H	B	LF		WF	Sıkma Vidası Screw Klemmschraube	Altlık Shim Unterlage	Altlık Vidası Shim Screw Schraube für Unterlage
●	●	12	12	80	16	VB.. 1103..	4008-M2.5x6	-	-	82-T08
●	●	16	16	100	20					
●	●	20	20	125	25					
●	●	20	20	125	25	VB.. 1604..	4015-M3.5x14	AAVN-2-0002	AAV-06-M3.5x11	80-T15
●	●	25	25	150	32					
●	●	32	32	170	40					

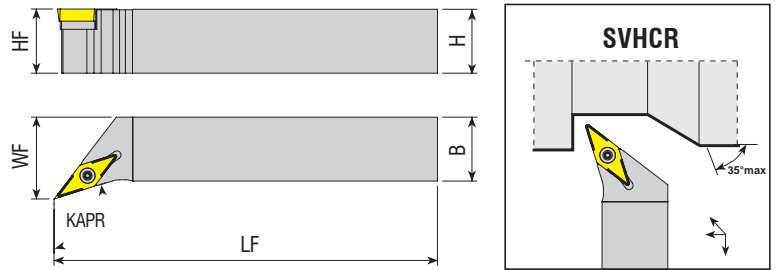
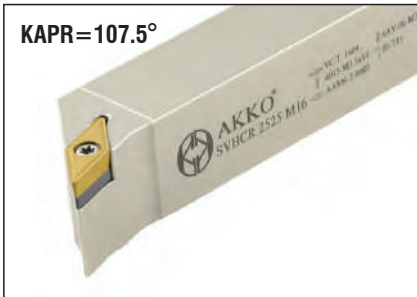

Takım Kodu
Ordering Code
Bestell-Bezeichnung

Stok Stock Lager	Takım Ölçüleri (mm) Dimension (mm) Abmessung (mm)					Kesici Uç Insert Wendeschneidplatte	Yedek Parçaları / Spare Parts / Ersatzteile			
	R	L	HF=H	B	LF		WF	Sıkma Vidası Screw Klemmschraube	Altlık Shim Unterlage	Altlık Vidası Shim Screw Schraube für Unterlage
●	●	12	12	80	16	VC.. 1103..	4008-M2.5x6	-	-	82-T08
●	●	16	16	100	20					
●	●	20	20	125	25					
●	●	20	20	125	25	VC.. 1604..	4015-M3.5x14	AAVN-2-0002	AAV-06-M3.5x11	80-T15
●	●	25	25	150	32					
●	●	32	32	170	40					

R: Sağ / Right / Rechts L: Sol / Left / Links

● Stokta / In Stock / Auf Lager ○ Stokta Yok / Non Stock Item / Kein Lagerartikel, Lieferzeit auf Anfrage

Sipariş Örneği/Ordering Example/Bestellbeispiel

1 ad./pcs./stück SVHBR 1212 F11

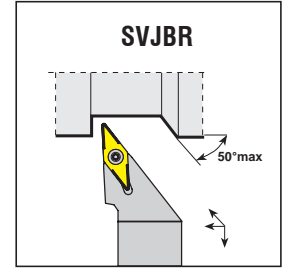
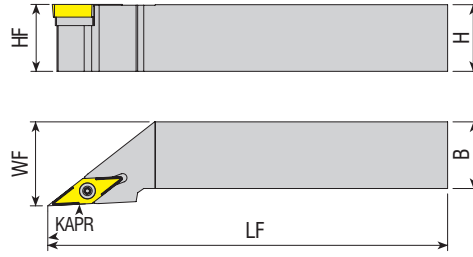

Takım Kodu
Ordering Code
Bestell-Bezeichnung

Stok Stock Lager	Takım Ölçüleri (mm) Dimension (mm) Abmessung (mm)					Kesici Uç Insert Wendeschneidplatte	Yedek Parçaları / Spare Parts / Ersatzteile			
	R	L	HF=H	B	LF		WF	Sıkma Vidası Screw Klemmschraube	Altık Shim Unterlage	Altık Vidası Shim Screw Schraube für Unterlage
●	●	12	12	80	16	VB.. 1103..	4008-M2.5x6	-	-	82-T08
●	●	16	16	100	20					
●	●	20	20	125	25					
●	●	16	16	100	20	VB.. 1604..	4015-M3.5x12	AAVN-2-0002	AAV-08-M3.5x8	80-T15
●	●	20	20	125	25		4015-M3.5x14		AAV-06-M3.5x11	
●	●	25	25	150	32					
●	●	32	32	170	40					

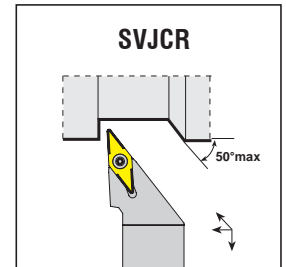
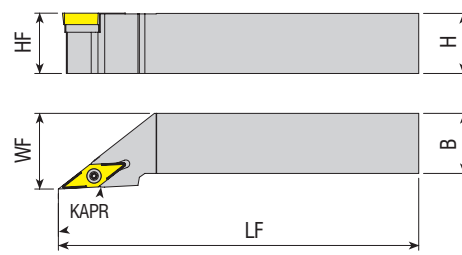

Takım Kodu
Ordering Code
Bestell-Bezeichnung

Stok Stock Lager	Takım Ölçüleri (mm) Dimension (mm) Abmessung (mm)					Kesici Uç Insert Wendeschneidplatte	Yedek Parçaları / Spare Parts / Ersatzteile			
	R	L	HF=H	B	LF		WF	Sıkma Vidası Screw Klemmschraube	Altık Shim Unterlage	Altık Vidası Shim Screw Schraube für Unterlage
●	●	12	12	80	16	VC.. 1103..	4008-M2.5x6	-	-	82-T08
●	●	16	16	100	20					
●	●	20	20	125	25					
●	●	12	12	80	16	VC.. 1604...	4015-M3.5x11	AAVN-2-0002	AAV-06-M3.5x11	80-T15
●	●	20	20	125	25		4015-M3.5x14			
●	●	25	25	150	32					
●	●	32	32	170	40					

R: Sağ / Right / Rechts L: Sol / Left / Links

● Stokta / In Stock / Auf Lager ○ Stokta Yok / Non Stock Item / Kein Lagerartikel, Lieferzeit auf Anfrage

Sipariş Örneği/Ordering Example/Bestellbeispiel

1 ad./pcs./stück SVJBR 1212 F11

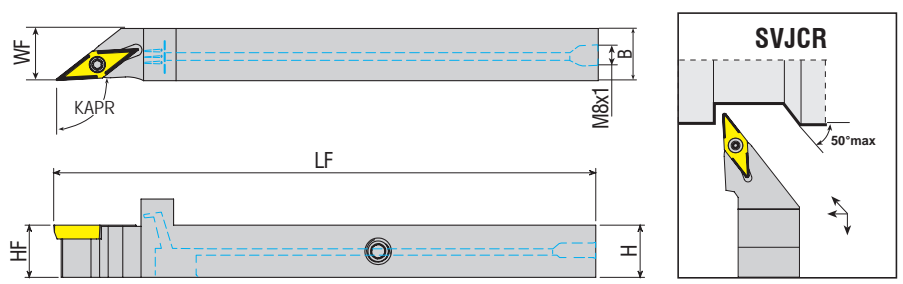

Takım Kodu Ordering Code Bestell-Bezeichnung	Stok Stock Lager		Takım Ölçüleri (mm) Dimension (mm) Abmessung (mm)				Kesici Uç Insert Wendeschneidplatte	Sıkma Vidası Screw Klemmschraube	Altlık Shim Unterlage	Altlık Vidası Shim Screw Schraube für Unterlage	Sızdırmaz Vida Threaded Pin Gewindestift	Anahtar Allen Key Innensechskantschlüssel	Tork Anahtar Torx Key Torx-Schlüssel
	R	L	HF=H	B	LF	WF							
SVJCR/L 1212 K11-SHC	●	○	12	12	125	12	VC.. 1103..	4008-M2.5x6	-	-	2703-M6X4	AAL-03-3	82-T08
SVJCR/L 1616 K11-SHC	●	○	16	16	125	16					2704-M8X1X5	AAL-05-4	

S-SİSTEM DIŞ TORNA KATERLERİ
S-SYSTEM EXTERNAL TURNING TOOLHOLDERS
S-SYSTEM AUSSEN - DREHHALTER

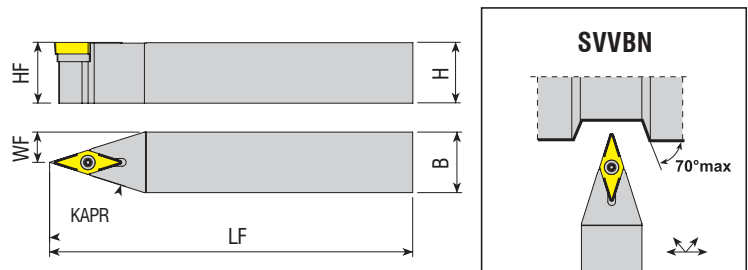

Takım Kodu Ordering Code Bestell-Bezeichnung	Stok Stock Lager	Takım Ölçüleri (mm) Dimension (mm) Abmessung (mm)				Kesici Uç Insert Wendeschneidplatte	Sıkma Vidası Screw Klemmschraube	Altlık Shim Unterlage	Altlık Vidası Shim Screw Schraube für Unterlage	Tork Anahtar Torx Key Torx-Schlüssel
		HF=H	B	LF	WF					
SVVBN 1212 F11	●	12	12	80	06	VB.. 1103..	4008-M2.5x6	-	-	82-T08
SVVBN 1616 H11	●	16	16	100	08					
SVVBN 2020 K11	●	20	20	125	10					
SVVBN 2020 K16	●	20	20	125	10	VB.. 1604..	4015-M3.5x14	AAVN-2-0002	AAV-06-M3.5x11	80-T15
SVVBN 2525 M16	●	25	25	150	12.5					
SVVBN 3232 P16	●	32	32	170	16					

R: Sağ / Right / Rechts L: Sol / Left / Links
● Stokta / In Stock / Auf Lager ○ Stokta Yok / Non Stock Item / Kein Lagerartikel, Lieferzeit auf Anfrage

Sipariş Örneği/Ordering Example/Bestellbeispiel
1 ad./pcs./stück SVJCR 1212 K11-SHC

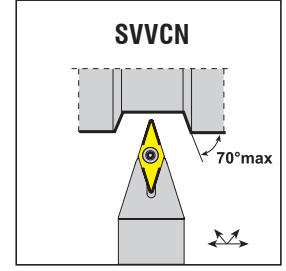
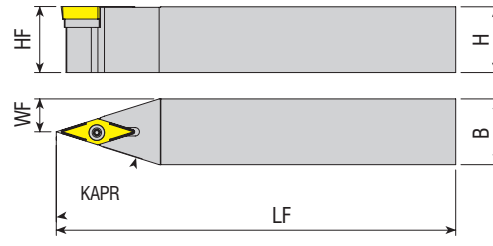

Takım Kodu Ordering Code Bestell-Bezeichnung	Stok Stock Lager	Takım Ölçüleri (mm) Dimension (mm) Abmessung (mm)				Kesici Uç Insert Wendeschneidplatte	Yedek Parçaları / Spare Parts / Ersatzteile			
		HF=H	B	LF	WF		Sıkma Vidası Screw Klemmschraube	Altlık Shim Unterlage	Altlık Vidası Shim Screw Schraube für Unterlage	Tork Anahtar Torx Key Torx-Schlüssel
SVVCN 1212 F11	●	12	12	80	06	VC.. 1103..	4008-M2.5x6	-	-	82-T08
SVVCN 1616 H11	●	16	16	100	08					
SVVCN 2020 K11	●	20	20	125	10					
SVVCN 2020 K16	●	20	20	125	10	VC.. 1604...	4015-M3.5x14	AAVN-2-0002	AAV-06-M3.5x11	80-T15
SVVCN 2525 M16	●	25	25	150	12.5					
SVVCN 3232 P16	●	32	32	170	16					

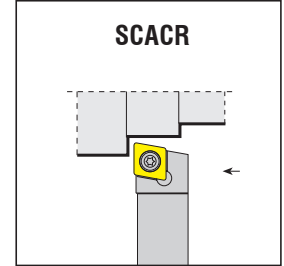
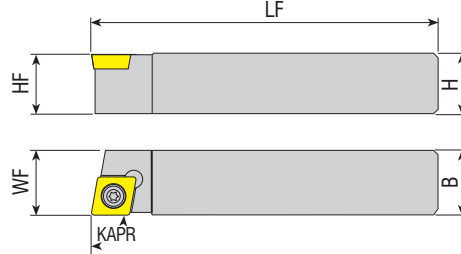
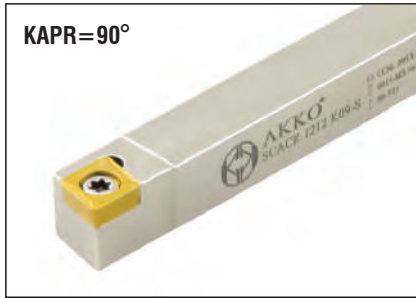

Takım Kodu Ordering Code Bestell-Bezeichnung	Stok Stock Lager		Takım Ölçüleri (mm) Dimension (mm) Abmessung (mm)				Kesici Uç Insert Wendeschneidplatte	Yedek Parçaları / Spare Parts / Ersatzteile			
	R	L	HF=H	B	LF	WF		Sıkma Vidası Screw Klemmschraube	Altlık Shim Unterlage	Altlık Vidası Shim Screw Schraube für Unterlage	Tork Anahtar Torx Key Torx-Schlüssel
SCACR/L 0808 X06-S	●	●	08	08	115	08	CC.. 0602..	4008-M2.5x6	-	-	82-T08
SCACR/L 1010 K06-S	●	○	10	10	125	10					
SCACR/L 1212 G06-S	●	○	12	12	90	12					
SCACR/L 1212 K06-S	●	○	12	12	125	12					
SCACR/L 1616 F06-S	○	○	16	16	75	16					
SCACR/L 1616 K06-S	○	○	16	16	125	16					
SCACR/L 1212 G09-S	○	○	12	12	90	12	CC.. 09T3..	4015-M3.5x11	-	-	80-T15
SCACR/L 1212 K09-S	●	●	12	12	125	12					
SCACR/L 1616 F09-S	○	○	16	16	75	16					
SCACR/L 1616 K09-S	●	●	16	16	125	16					
SCACR/L 2020 K09-S	●	●	20	20	125	20					

R: Sağ / Right / Rechts L: Sol / Left / Links

● Stokta / In Stock / Auf Lager ○ Stokta Yok / Non Stock Item / Kein Lagerartikel, Lieferzeit auf Anfrage

Sipariş Örneği/Ordering Example/Bestellbeispiel

1 ad./pcs./stück SVVCN 1212 F11

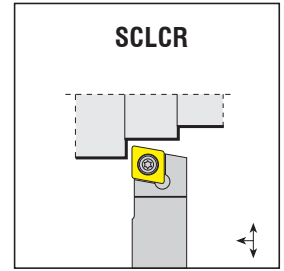
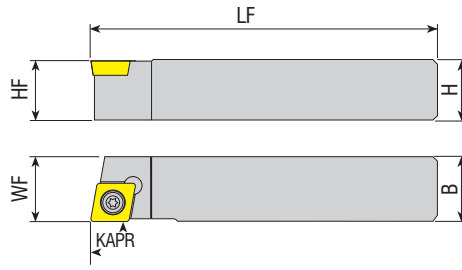
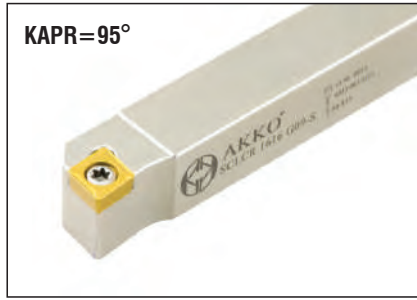

Takım Kodu
Ordering Code
Bestell-Bezeichnung

Stok Stock Lager	Takım Ölçüleri (mm) Dimension (mm) Abmessung (mm)						Kesici Uç Insert Wendeschneidplatte	Sıkma Vidası Screw Klemmschraube	Altlık Shim Unterlage	Altlık Vidası Shim Screw Schraube für Unterlage	Tork Anahtar Torx Key Torx-Schlüssel
	R	L	HF=H	B	LF	WF					
●	●	08	08	115	08	CC.. 0602..				82-T08	
●	○	10	10	115	10						
●	●	12	12	90	12						
●	○	12	12	130	12						
○	●	12	12	125	12						
●	○	16	16	75	16						
●	○	16	16	130	16						
●	●	12	12	90	12	CC.. 09T3..			80-T15		
●	○	12	12	130	12						
●	○	16	16	75	16						
●	○	16	16	90	16						
●	○	16	16	90	16						
●	○	16	16	115	16						
●	○	20	20	120	20						

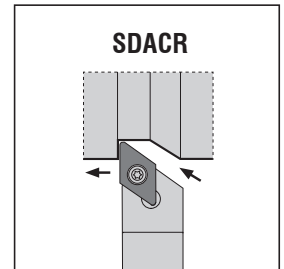
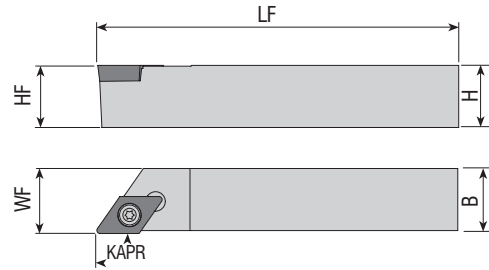
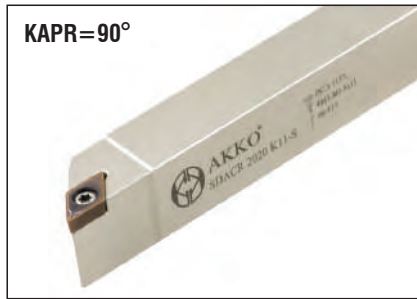

Takım Kodu
Ordering Code
Bestell-Bezeichnung

Stok Stock Lager	Takım Ölçüleri (mm) Dimension (mm) Abmessung (mm)						Kesici Uç Insert Wendeschneidplatte	Sıkma Vidası Screw Klemmschraube	Altlık Shim Unterlage	Altlık Vidası Shim Screw Schraube für Unterlage	Tork Anahtar Torx Key Torx-Schlüssel
	R	L	HF=H	B	LF	WF					
●	●	08	08	115	08	DC.. 0702..				82-T08	
●	●	10	10	125	10						
○	○	12	12	90	12						
●	●	12	12	125	12						
●	○	16	16	75	16						
●	●	16	16	125	16	DC.. 11T3..				80-T15	
○	○	12	12	90	12						
●	●	12	12	125	12						
●	●	16	16	75	16						
●	●	16	16	125	16						
●	●	20	20	125	20						

R: Sağ / Right / Rechts L: Sol / Left / Links

● Stokta / In Stock / Auf Lager ○ Stokta Yok / Non Stock Item / Kein Lagerartikel, Lieferzeit auf Anfrage

Sipariş Örneği/Ordering Example/Bestellbeispiel

1 ad./pcs./stück SCLCR 0808 X06-S

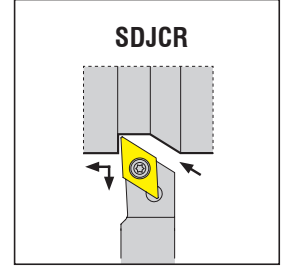
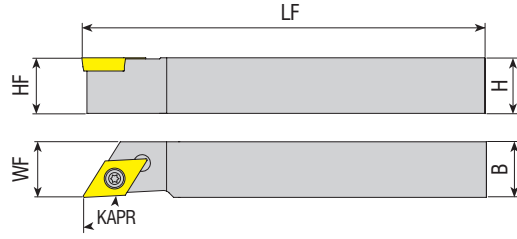
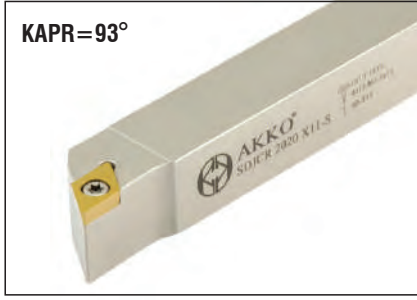

Takım Kodu Ordering Code Bestell-Bezeichnung	Stok Stock Lager		Takım Ölçüleri (mm) Dimension (mm) Abmessung (mm)				Kesici Uç Insert Wendeschneidplatte	Yedek Parçaları / Spare Parts / Ersatzteile			
	R	L	HF=H	B	LF	WF		Sıkma Vidası Screw Klemmschraube	Altlık Shim Unterlage	Altlık Vidası Shim Screw Schraube für Unterlage	Tork Anahtar Torx Key Torx-Schlüssel
SDJCR/L 0808 X07-S	●	○	08	08	115	08	DC.. 0702..	4008-M2.5x6	-	-	82-T08
SDJCR/L 1010 X07-S	●	●	10	10	115	10					
SDJCR/L 1212 G07-S	●	○	12	12	90	12					
SDJCR/L 1212 X07-S	●	●	12	12	130	12					
SDJCR/L 1616 F07-S	●	○	16	16	75	16					
SDJCR/L 1616 X07-S	●	○	16	16	130	16					
SDJCR/L 2020 X07-S	●	○	20	20	120	20	DC.. 11T3..	4015-M3.5x11	-	-	80-T15
SDJCR/L 1212 G11-S	●	○	12	12	90	12					
SDJCR/L 1212 X11-S	●	●	12	12	130	12					
SDJCR/L 1212 K11-S	●	●	12	12	125	12					
SDJCR/L 1616 F11-S	●	○	16	16	75	16					
SDJCR/L 1616 X11-S	●	●	16	16	130	16					
SDJCR/L 1616 K11-S	●	●	16	16	125	16					
SDJCR/L 2020 X11-S	●	○	20	20	120	20					

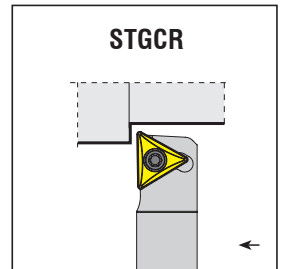
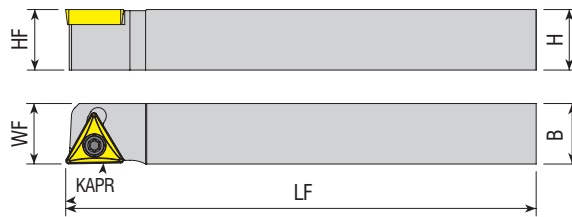

Takım Kodu Ordering Code Bestell-Bezeichnung	Stok Stock Lager		Takım Ölçüleri (mm) Dimension (mm) Abmessung (mm)				Kesici Uç Insert Wendeschneidplatte	Yedek Parçaları / Spare Parts / Ersatzteile			
	R	L	HF=H	B	LF	WF		Sıkma Vidası Screw Klemmschraube	Altlık Shim Unterlage	Altlık Vidası Shim Screw Schraube für Unterlage	Tork Anahtar Torx Key Torx-Schlüssel
STGCR/L 1216 K11-S	●	○	12	16	125	16	TC.. 1102..	4008-M2.5x6	-	-	82-T08
STGCR/L 1616 K11-S	●	○	16	16	125	16					
STGCR/L 1216 K16-S	●	○	12	16	125	16	TC.. 16T3..	4015-M3.5x11	-	-	80-T15
STGCR/L 1616 K16-S	●	○	16	16	125	16					

R: Sağ / Right / Rechts L: Sol / Left / Links

● Stokta / In Stock / Auf Lager ○ Stokta Yok / Non Stock Item / Kein Lagerartikel, Lieferzeit auf Anfrage

Sipariş Örneği/Ordering Example/Bestellbeispiel

1 ad./pcs./stück SDJCR 0808 X07-S

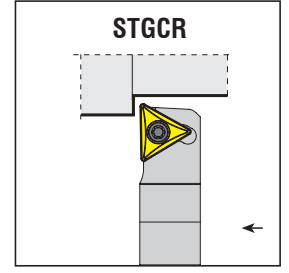
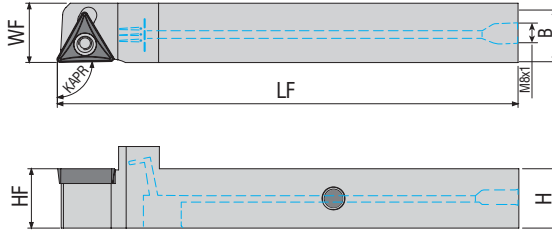





Takım Kodu
Ordering Code
Bestell-Bezeichnung

Stok Stock Lager		Takım Ölçüleri (mm) Dimension (mm) Abmessung (mm)				
R	L	HF=H	B	LF	WF	
●	○	12	16	125	16	
●	○	16	16	125	16	

STGCR/L 1216 K16-SHC
STGCR/L 1616 K16-SHC

Kesici Uç Insert Wendeschneidplatte

TC.. 16T3..

Yedek Parçaları / Spare Parts / Ersatzteile				
Sıkma Vidası Screw Klemmschraube	Sızdırmaz Vida Threaded Pin Gewindestift	Anahtar Allen Key Innensechskantschlüssel	Tork Anahtar Torx Key Torx-Schlüssel	
				
4015-M3.5x11	2703-M6X4 2704-M8X1X5	AAL-03-3 AAL-05-4	80-T15	

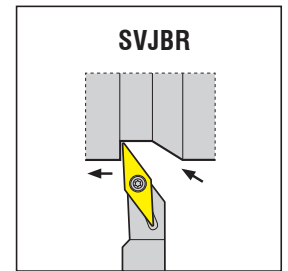
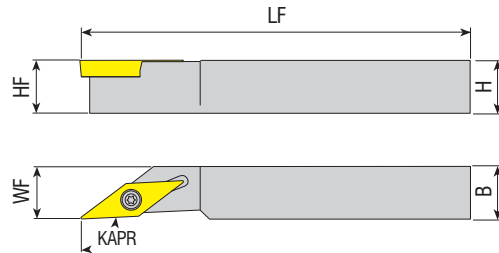





Takım Kodu
Ordering Code
Bestell-Bezeichnung

Stok Stock Lager		Takım Ölçüleri (mm) Dimension (mm) Abmessung (mm)				
R	L	HF=H	B	LF	WF	
●	●	16	16	125	16	

SVJBR/L 1616 K11-S

Kesici Uç Insert Wendeschneidplatte

VB.. 1103..

Yedek Parçaları / Spare Parts / Ersatzteile				
Sıkma Vidası Screw Klemmschraube	Altlık Shim Unterlage	Altlık Vidası Shim Screw Schraube für Unterlage	Tork Anahtar Torx Key Torx-Schlüssel	
				
4008-M2.5x6	-	-	82-T08	

R: Sağ / Right / Rechts L: Sol / Left / Links
● Stokta / In Stock / Auf Lager ○ Stokta Yok / Non Stock Item / Kein Lagerartikel, Lieferzeit auf Anfrage

Sipariş Örneği/Ordering Example/Bestellbeispiel
1 ad./pcs./stück STGCR 1216 K16-SHC

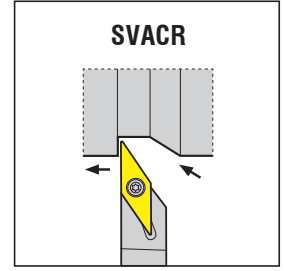
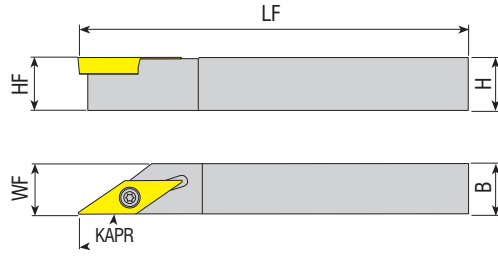

Takım Kodu Ordering Code Bestell-Bezeichnung	Stok Stock Lager		Takım Ölçüleri (mm) Dimension (mm) Abmessung (mm)				Kesici Uç Insert Wendeschneidplatte	Yedek Parçaları / Spare Parts / Ersatzteile			
	R	L	HF=H	B	LF	WF		Sıkma Vidası Screw Klemmschraube	Altlık Shim Unterlage	Altlık Vidası Shim Screw Schraube für Unterlage	Tork Anahtar Torx Key Torx-Schlüssel
SVACR/L 0808 X11-S	○	○	08	08	115	08	VC.. 1103..	4008-M2.5x6	-	-	82-T08
SVACR/L 1010 K11-S	●	○	10	10	125	10					
SVACR/L 1212 G11-S	○	○	12	12	90	12					
SVACR/L 1212 K11-S	●	●	12	12	125	12					
SVACR/L 1616 F11-S	○	○	16	16	75	16					
SVACR/L 1616 K11-S	●	●	16	16	125	16					
SVACR/L 2020 K11-S	●	●	20	20	125	20					
SVACR/L 1212 K16-S	●	●	12	12	125	12	VC.. 1604...	4015-M3.5x11		80-T15	
SVACR/L 1616 K16-S	●	●	16	16	125	16					

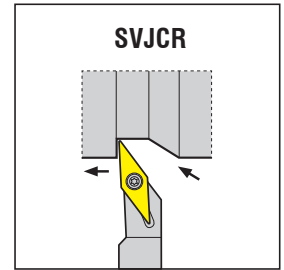
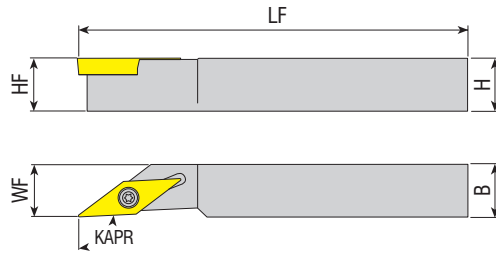

Takım Kodu Ordering Code Bestell-Bezeichnung	Stok Stock Lager		Takım Ölçüleri (mm) Dimension (mm) Abmessung (mm)				Kesici Uç Insert Wendeschneidplatte	Yedek Parçaları / Spare Parts / Ersatzteile			
	R	L	HF=H	B	LF	WF		Sıkma Vidası Screw Klemmschraube	Altlık Shim Unterlage	Altlık Vidası Shim Screw Schraube für Unterlage	Tork Anahtar Torx Key Torx-Schlüssel
SVJCR/L 0808 X11-S	●	○	08	08	115	08	VC.. 1103..	4008-M2.5x6	-	-	82-T08
SVJCR/L 1010 K11-S	●	○	10	10	125	10					
SVJCR/L 1212 G11-S	●	○	12	12	90	12					
SVJCR/L 1212 K11-S	●	●	12	12	125	12					
SVJCR/L 1616 F11-S	○	○	16	16	75	16					
SVJCR/L 1616 K11-S	●	○	16	16	125	16					
SVJCR/L 2020 K11-S	○	○	20	20	125	20					
new SVJCR/L 1616 K16-S	●	●	16	16	125	16	VC.. 1604...	4015-M3.5x14	AAVN-2-0002	AAV-08-M3.5x8 AAV-06-M3.5x11	80-T15
new SVJCR/L 2020 K16-S	●	●	20	20	125	20					

R: Sağ / Right / Rechts L: Sol / Left / Links

● Stokta / In Stock / Auf Lager ○ Stokta Yok / Non Stock Item / Kein Lagerartikel, Lieferzeit auf Anfrage

Sipariş Örneği/Ordering Example/Bestellbeispiel

1 ad./pcs./stück SVACR 0808 X11-S

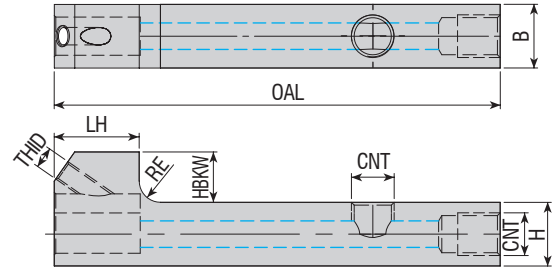

Takım Kodu Ordering Code Bestell-Bezeichnung	Stok Stock Lager		Takım Ölçüleri (mm) Dimension (mm) Abmessung (mm)							Yedek Parçaları / Spare Parts / Ersatzteile		
	H	B	RE	HBKW	LH	OAL	CNT	THID	Sızdırmaz Vida Threaded Pin Gewindestift	Montaj Vidası Mounting Screw Монтажный винт	Anahtar Allen Key Innensechskantschlüssel	
ASTB-1212-L84-H	●	12	12	4	9.5	16	84	M8X1X5	M4x0.7			
ASTB-1616-L90-H	●	16	16	1	5.5	16	90	M8X1X5	M4x0.7	2704-M8X1X5	2503-M4x12-C	AAL-03-3

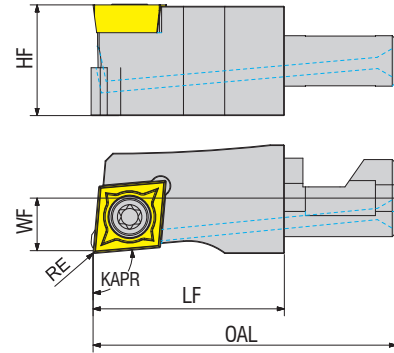

Takım Kodu Ordering Code Bestell-Bezeichnung	Stok Stock Lager		Takım Ölçüleri (mm) Dimension (mm) Abmessung (mm)					Kesici Uç Insert Wendeschneidplatte	Yedek Parçaları / Spare Parts / Ersatzteile	
	R	L	HF	WF	RE	LF	OAL	Sıkma Vidası Screw Klemmschraube	Tork Anahtar Torx Key Torx-Schlüssel	
SCLCR/L-12X43.3-06-H	●	●	11.8	8	0.2	27.3	43.3			
SCLCR/L-16X43.3-06-H	●	●	15.8	8	0.2	27.3	43.3	CC.. 0602..	4008-M2.5x6	82-T08
SCLCR/L-12X43.3-09-H	●	●	11.8	8	0.2	27.3	43.3	CC.. 09T3..	4015-M3.5x8	80-T15
SCLCR/L-16X43.3-09-H	●	●	15.8	8	0.2	27.3	43.3			

R: Sağ / Right / Rechts L: Sol / Left / Links

● Stokta / In Stock / Auf Lager ○ Stokta Yok / Non Stock Item / Kein Lagerartikel, Lieferzeit auf Anfrage

Sipariş Örneği/Ordering Example/Bestellbeispiel
1 ad./pcs./stück ASTB-1212-L84-H

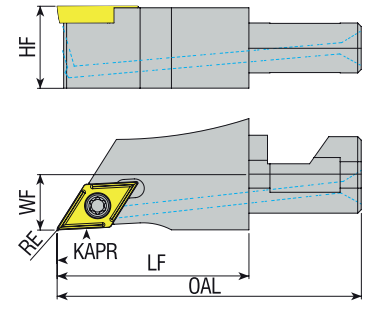

Takım Kodu Ordering Code Bestell-Bezeichnung	Stok Stock Lager		Takım Ölçüleri (mm) Dimension (mm) Abmessung (mm)					Kesici Uç Insert Wendescheidplatte	Yedek Parçaları / Spare Parts / Ersatzteile		
	R	L	HF	WF	RE	LF	OAL		Sıkma Vidası Screw Klemmschraube	Tork Anahtar Torx Key Torx-Schlüssel	
SDJCR/L 12X43.3-07	●	●	11.8	8	0.2	27.3	43.3				
SDJCR/L 12X43.3-07-H	●	●	11.8	8	0.2	27.3	43.3				
SDJCR/L 16X43.3-07	●	●	15.8	8	0.2	27.3	43.3				
SDJCR/L 16X43.3-07-H	●	●	15.8	8	0.2	27.3	43.3				
SDJCR/L 12X43.3-11	●	●	11.8	8	0.2	27.3	43.3				
SDJCR/L 12X43.3-11-H	●	●	11.8	8	0.2	27.3	43.3				
SDJCR/L 16X43.3-11	●	●	15.8	8	0.2	27.3	43.3				
SDJCR/L 16X43.3-11-H	●	●	15.8	8	0.2	27.3	43.3				

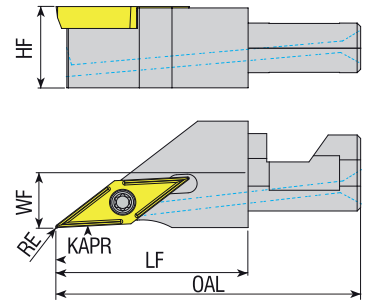





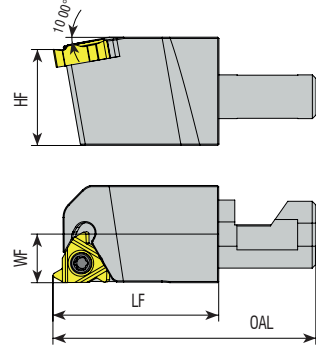

Takım Kodu Ordering Code Bestell-Bezeichnung	Stok Stock Lager		Takım Ölçüleri (mm) Dimension (mm) Abmessung (mm)					Kesici Uç Insert Wendescheidplatte	Yedek Parçaları / Spare Parts / Ersatzteile		
	R	L	HF	WF	RE	LF	OAL		Sıkma Vidası Screw Klemmschraube	Tork Anahtar Torx Key Torx-Schlüssel	
SVJCR/L 12X43.3-11	●	●	11.8	8	0.2	27.3	43.3				
SVJCR/L 12X43.3-11-H	●	●	11.8	8	0.2	27.3	43.3				
SVJCR/L 16X43.3-11	●	●	15.8	8	0.2	27.3	43.3				
SVJCR/L 16X43.3-11-H	●	●	15.8	8	0.2	27.3	43.3				

R: Sağ / Right / Rechts L: Sol / Left / Links
 ● Stokta / In Stock / Auf Lager ○ Stokta Yok / Non Stock Item / Kein Lagerartikel, Lieferzeit auf Anfrage

Sipariş Örneği/Ordering Example/Bestellbeispiel
 1 ad./pcs./stück SDJCR/L 12X43.3-07



Takım Kodu
Ordering Code
Bestell-Bezeichnung

Stok Stock Lager		Takım Ölçüleri (mm) Dimension (mm) Abmessung (mm)					Kesici Uç Insert Wendeschneidplatte	Sıkma Vidası Screw Klemmschraube	Sağ Altlık Right Shim U-Platte für WSP/rechts	Sol Altlık Left Shim U-Platte für WSP/links	Altık Vidası Shim Screw Schraube für Unterlage	Altık Vidası Pulu Shim Screw Ring Schraube für Unterlagering	Tork Anahtar Torx Key Torx-Schlüssel
R	L	OAL	LF	WF	HF								
●	●	43.3	27.3	8	11.8								
●	●	43.3	27.3	8	15.8	11 ER/EL	4008-M2.5x6	-	-	-	-	82-T08	
●	●	43.3	27.3	8	15.8	16 ER/EL	1710-U5-40x12.2	ATS-16E	ATS-16I	AAV-11-U5-40x4.5	ABPL-03	82-T10	

Sipariş Örneği/Ordering Example/Bestellbeispiel
1 ad./pcs./stück SER-12x43.3-11

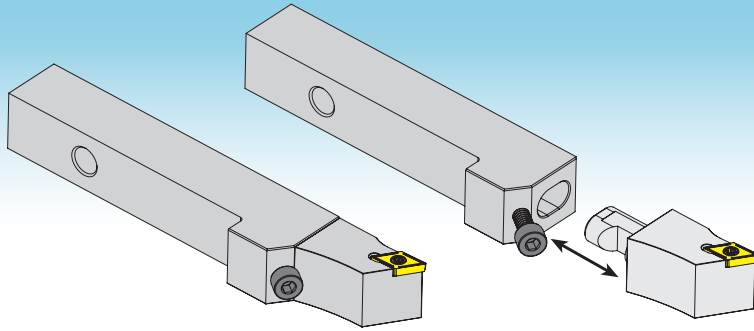

Takım tutucuyu, bağlama ünitesinden sökme zorunluğu kalmadan hızlıca değiştirin!

Quick change, without having to remove the tool-holder from the gang !

Es ist nicht nötig, den Grundhalter vom Werkzeugträger zu entfernen schnelle wechsell möglich!

Makina dışında ön ayar yapmak mümkün.

Presetting is possible outside of the machine.

Voreinstellung ausserhalb der Maschine ist möglich.

Çok hassas montaj.

Ultra precise fitting.

Ultra-präziser Montage.

Rijit sabitleme.

Rigid fixation.

Starre Befestigung.

Takım tutucu bölümü: 12x12 ve 16x16 mm.

Tool-holder section : 12x12 and 16x16 mm.

Grundhalter: 12x12 und 16x16mm.

Sağ ve sol uçlar kullanılır.

Left and right inserts available.

Links und Rechts WSP verwendbar.

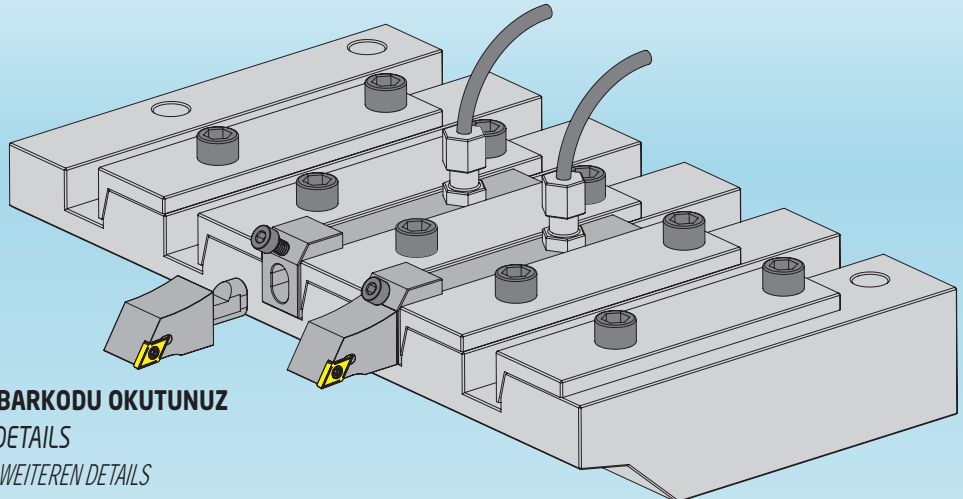
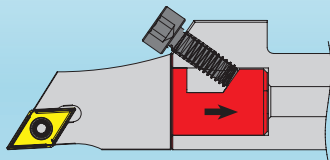

DETAYLI BİLGİ İÇİN BARKODU OKUTUNUZ
SCAN ME FOR MORE DETAILS
SCANNEN SIE MICH NACH WEITEREN DETAILS