



*konusulan  
the spoken kalite...  
quality...*

# T-SİSTEM

**T-SİSTEM DIŞ TORNA KATERLERİ**

T-SYSTEM EXTERNAL TURNING TOOLHOLDERS

T-SYSTEM AUSSEN - DREHHALTER MIT INNENKÜHLUNG









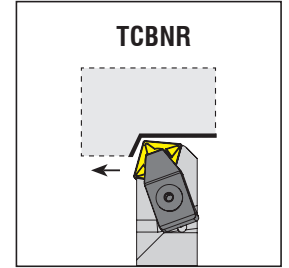
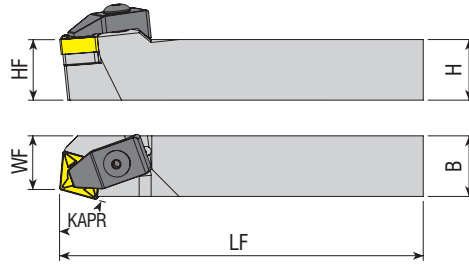
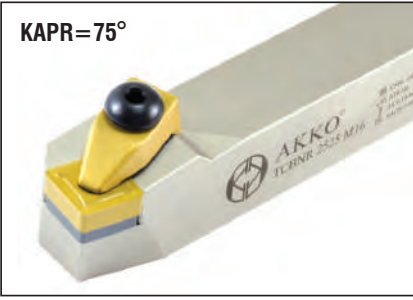

**DETAYLI BİLGİ İÇİN BARKODU OKUTUNUZ**







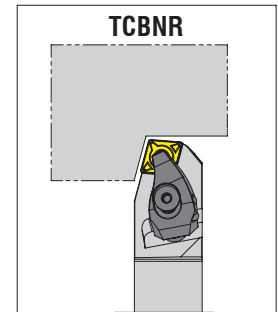
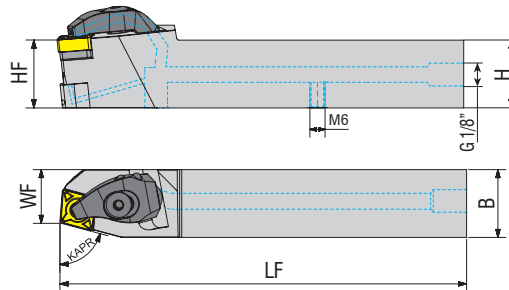

SCAN ME FOR MORE DETAILS

FÜR DETAILS BITTE DEN QR CODE SCANNEN



Takım Kodu Ordering Code Bestell-Bezeichnung	Stok Stock Lager		Takım Ölçüleri (mm) Dimension (mm) Abmessung (mm)				Kesici Uç Insert Wendeschneidplatte	Yedek Parçaları / Spare Parts / Ersatzteile							
	R	L	HF=H	B	LF	WF		Baskı Pabucu Wedge Clamp Spannpratze	Pabuç Vidası Clamp Screw Klemmschraube	Altlık Shim Unterlage	Altlık Vidası Shim Screw Schraube für Unterlage	Segman Ring Feder	Pul Stamp Ring	Anahtar Allen Key Innensechskantschlüssel	
TCBNR/L 2525 M16	●	●	25	25	150	22									



Takım Kodu Ordering Code Bestell-Bezeichnung	Stok Stock Lager		Takım Ölçüleri (mm) Dimension (mm) Abmessung (mm)				Kesici Uç Insert Wendeschneidplatte	Yedek Parçaları / Spare Parts / Ersatzteile															
	R	L	HF=H	B	LF	WF		Baskı Pabucu Wedge Clamp Spannpratze	Pabuç Vidası Clamp Screw Klemmschraube	Altlık Shim Unterlage	Altlık Vidası Shim Screw Schraube für Unterlage	Yay Spring Feder	Oring Ring Feder	Sızdırmaz Vida Threaded Pin Gewindestift	Anahtar Allen Key Innensechskantschlüssel								
TCBNR/L 2020 K12-H	○	○	20	20	125	16																	
TCBNR/L 2525 M12-H	○	○	25	25	150	22									CN.. 1204..	ATKH-01-R ATKH-02-L	AKV-33-M6x22	AACN-3-0001	AAV-02-M5x12	AKY-01	AXR-01	2705-G1/8x5.5	AAL-03-3
TCBNR/L 3232 P12-H	○	○	32	32	170	29.5																	

R: Sağ / Right / Rechts L: Sol / Left / Links

● Stokta / In Stock / Auf Lager ○ Stokta Yok / Non Stock Item / Kein Lagerartikel, Lieferzeit auf Anfrage

VDI tutucu ile uyumludur. / Compatible with VDI holders. / Kompatibel mit VDI Werkzeughalter.

Sipariş Örneği/Ordering Example/Bestellbeispiel

1 ad./pcs./stück TCBNR 2525 M16

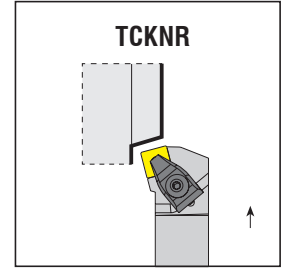
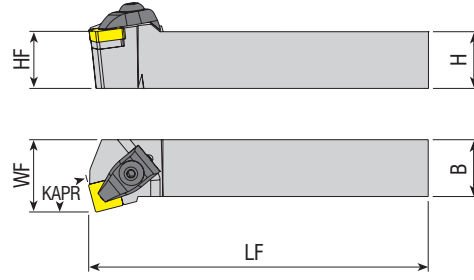

Takım Kodu Ordering Code Bestell-Bezeichnung	Stok Stock Lager		Takım Ölçüleri (mm) Dimension (mm) Abmessung (mm)				Kesici Uç Insert Wendeschneidplatte	Yedek Parçaları / Spare Parts / Ersatzteile							
	R	L	HF=H	B	LF	WF		Baskı Pabucu Wedge Clamp Spannpratze	Pabuç Vidası Clamp Screw Klemmschraube	Altlık Shim Unterlage	Altlık Vidası Shim Screw Schraube für Unterlage	Segman Ring Feder	Pul Stamp Ring	Anahtar Allen Key Innensechskantschlüssel	
TCKNR/L 2020 K12	●	●	20	20	125	25	CN.. 1204..	ATK-02	AKV-30-M6x22	AACN-3-0001	AAV-02-M5x12	AS-01	ABPL-01	AAL-03-3	
TCKNR/L 2525 M12	●	●	25	25	150	32									
TCKNR/L 3232 P12	●	●	32	32	170	40									
TCKNR/L 2525 M16	●	●	25	25	150	32	CN.. 1606..	ATK-04	AKV-19-M7x25	AACN-3-0002	AAV-05-M6x15	AS-02	ABPL-02	AAL-05-4	
TCKNR/L 3232 P16	●	●	32	32	170	40									

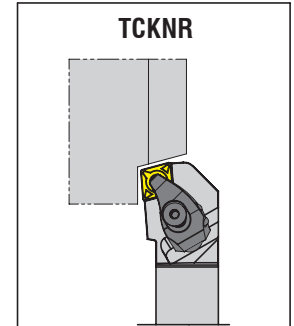
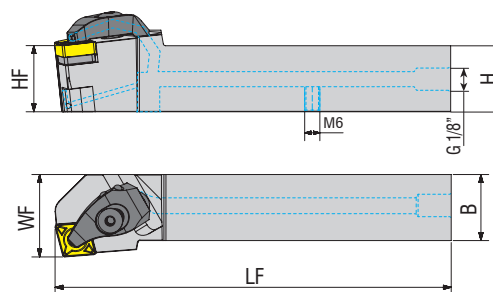

Takım Kodu Ordering Code Bestell-Bezeichnung	Stok Stock Lager		Takım Ölçüleri (mm) Dimension (mm) Abmessung (mm)				Kesici Uç Insert Wendeschneidplatte	Yedek Parçaları / Spare Parts / Ersatzteile							
	R	L	HF=H	B	LF	WF		Baskı Pabucu Wedge Clamp Spannpratze	Pabuç Vidası Clamp Screw Klemmschraube	Altlık Shim Unterlage	Altlık Vidası Shim Screw Schraube für Unterlage	Yay Spring Feder	Oring Ring Feder	Sızdırmaz Vida Threaded Pin Gewindestift	Anahtar Allen Key Innensechskantschlüssel
TCKNR/L 2020 K12-H	○	○	20	20	125	25	CN.. 1204..	ATKH-01-R ATKH-02-L	AKV-33-M6x22	AACN-3-0001	AAV-13-M5x8	AKY-01	AXR-01	2705-G1/8x5.5	AAL-03-3
TCKNR/L 2525 M12-H	○	○	25	25	150	32									
TCKNR/L 3232 P12-H	○	○	32	32	170	40									

R: Sağ / Right / Rechts L: Sol / Left / Links

● Stokta / In Stock / Auf Lager ○ Stokta Yok / Non Stock Item / Kein Lagerartikel, Lieferzeit auf Anfrage

VDI tutucu ile uyumludur. / Compatible with VDI holders. / Kompatibel mit VDI Werkzeughalter.

Sipariş Örneği/Ordering Example/Bestellbeispiel

1 ad./pcs./stück TCKNR 2020 K12

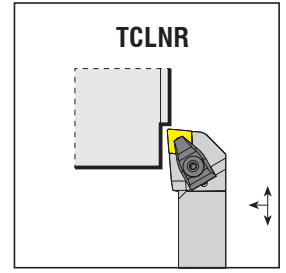
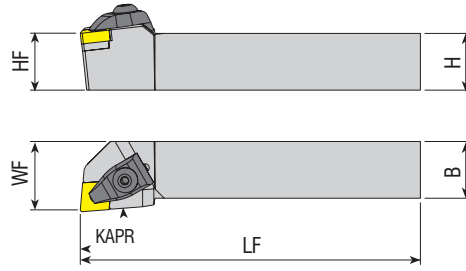

Takım Kodu Ordering Code Bestell-Bezeichnung	Stok Stock Lager		Takım Ölçüleri (mm) Dimension (mm) Abmessung (mm)				Kesici Uç Insert Wendeschneidplatte	Yedek Parçaları / Spare Parts / Ersatzteile						
	R	L	HF=H	B	LF	WF		Baskı Pabucu Wedge Clamp Spannpratze	Pabuç Vidası Clamp Screw Klemmschraube	Altlık Shim Unterlage	Altlık Vidası Shim Screw Schraube für Unterlage	Segman Ring Feder	Pul Stamp Ring	Anahtar Allen Key Innensechskantschlüssel
TCLNR/L 2020 K12	●	●	20	20	125	25	CN.. 1204..							
TCLNR/L 2525 M12	●	●	25	25	150	32								
TCLNR/L 3232 P12	●	●	32	32	170	40								
TCLNR/L 4040 S12	●	●	40	40	250	50								
TCLNR/L 5050 S12	●	●	50	50	250	63								
TCLNR/L 2525 M16	●	●	25	25	150	32	CN.. 1606..							
TCLNR/L 3232 P16	●	●	32	32	170	40								

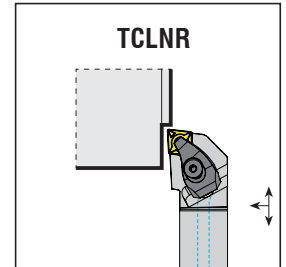
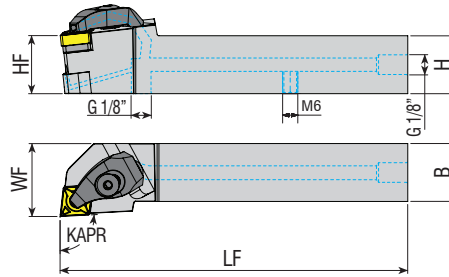

Takım Kodu Ordering Code Bestell-Bezeichnung	Stok Stock Lager		Takım Ölçüleri (mm) Dimension (mm) Abmessung (mm)				Kesici Uç Insert Wendeschneidplatte	Yedek Parçaları / Spare Parts / Ersatzteile							
	R	L	HF=H	B	LF	WF		Baskı Pabucu Wedge Clamp Spannpratze	Pabuç Vidası Clamp Screw Klemmschraube	Altlık Shim Unterlage	Altlık Vidası Shim Screw Schraube für Unterlage	Yay Spring Feder	Oring Ring Feder	Sızdırmaz Vida Threaded Pin Gewindestift	Anahtar Allen Key Innensechskantschlüssel
TCLNR/L 2020 K12-H	●	●	20	20	125	25	CN.. 1204..								
TCLNR/L 2525 M12-H	●	●	25	25	150	32									
TCLNR/L 3232 P12-H	●	●	32	32	170	40									
<b>new</b> TCLNR/L 2525 M16-H	●	○	25	25	150	32	CN.. 1606..								

R: Sağ / Right / Rechts L: Sol / Left / Links

● Stokta / In Stock / Auf Lager ○ Stokta Yok / Non Stock Item / Kein Lagerartikel, Lieferzeit auf Anfrage

VDI tutucu ile uyumludur. / Compatible with VDI holders. / Kompatibel mit VDI Werkzeughalter.

Sipariş Örneği/Ordering Example/Bestellbeispiel

1 ad./pcs./stück TCLNR 2020 K12

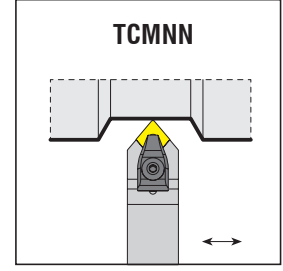
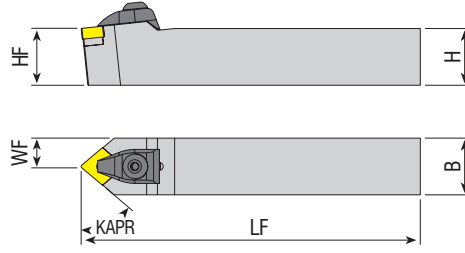
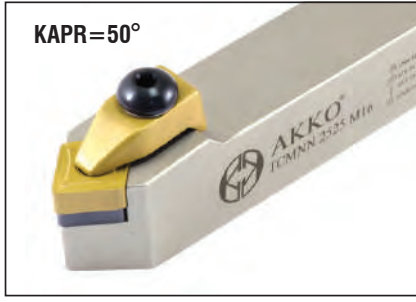

Takım Kodu Ordering Code Bestell-Bezeichnung	Stok Stock Lager	Takım Ölçüleri (mm) Dimension (mm) Abmessung (mm)				Kesici Uç Insert Wendeschneidplatte	Yedek Parçaları / Spare Parts / Ersatzteile								
		HF=H	B	LF	WF		Baskı Pabucu Wedge Clamp Spannpratze	Pabuç Vidası Clamp Screw Klemmschraube	Altlık Shim Unterlage	Altlık Vidası Shim Screw Schraube für Unterlage	Segman Ring Feder	Pul Stamp Ring	Anahtar Allen Key Innensechskantschlüssel		
TCMNN 1616 H12	●	16	16	100	8	CN.. 1204..									
TCMNN 2020 K12	●	20	20	125	10										
TCMNN 2525 M12	●	25	25	150	12.5										
TCMNN 3232 P12	●	32	32	170	16										
TCMNN 2525 M16	●	25	25	150	12.5	CN.. 1606..									
TCMNN 3232 P16	●	32	32	170	16										
TCMNN 4040 S16	○	40	40	250	20										

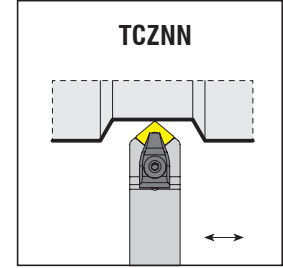
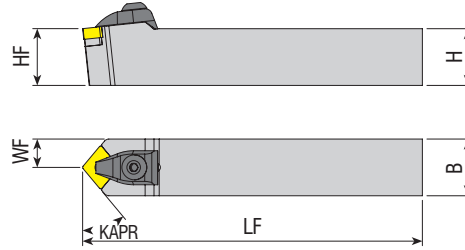

Takım Kodu Ordering Code Bestell-Bezeichnung	Stok Stock Lager	Takım Ölçüleri (mm) Dimension (mm) Abmessung (mm)				Kesici Uç Insert Wendeschneidplatte	Yedek Parçaları / Spare Parts / Ersatzteile								
		HF=H	B	LF	WF		Baskı Pabucu Wedge Clamp Spannpratze	Pabuç Vidası Clamp Screw Klemmschraube	Altlık Shim Unterlage	Altlık Vidası Shim Screw Schraube für Unterlage	Segman Ring Feder	Pul Stamp Ring	Anahtar Allen Key Innensechskantschlüssel		
TCZNN 2020 K12	●	20	20	125	10	CN.. 1204..									
TCZNN 2525 M12	●	25	25	150	12.5										
TCZNN 3232 P12	●	32	32	170	16										
TCZNN 2525 M16	●	25	25	150	12.5	CN.. 1606..									
TCZNN 3232 P16	●	32	32	170	16										

R: Sağ / Right / Rechts L: Sol / Left / Links

● Stokta / In Stock / Auf Lager ○ Stokta Yok / Non Stock Item / Kein Lagerartikel, Lieferzeit auf Anfrage

Sipariş Örneği/Ordering Example/Bestellbeispiel

1 ad./pcs./stück TCMNN 1616 H12

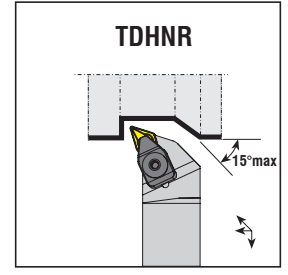
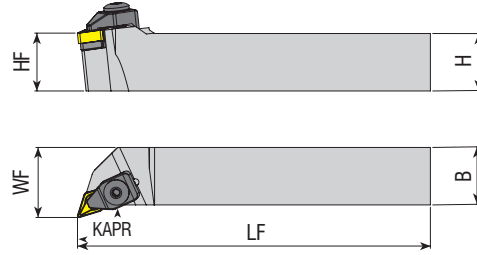

Takım Kodu Ordering Code Bestell-Bezeichnung	Stok Stock Lager		Takım Ölçüleri (mm) Dimension (mm) Abmessung (mm)				Kesici Uç Insert Wendeschneidplatte	Yedek Parçaları / Spare Parts / Ersatzteile						
	R	L	HF=H	B	LF	WF		Baskı Pabuçu Wedge Clamp Spannpratze	Pabuç Vidası Clamp Screw Klemmschraube	Altlık Shim Unterlage	Altlık Vidası Shim Screw Schraube für Unterlage	Segman Ring Feder	Pul Stamp Ring	Anahtar Allen Key Innensechskantschlüssel
TDHNR/L 2525 M11	○	●	25	25	150	31	DN.. 1104..	ATK-01	AKV-01-M5x22	AADN-2-0001	AAV-04-M5x12	-		
TDHNR/L 2020 K15	●	●	20	20	125	25								
TDHNR/L 2525 M15	●	●	25	25	150	32	DN.. 1506..	ATK-02	AKV-30-M6x22	AADN-3-0001	AAV-02-M5x12	AS-01	ABPL-01	AAL-03-3
TDHNR/L 3232 P15	●	●	32	32	170	40								

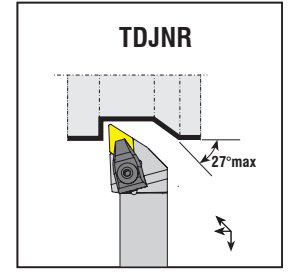
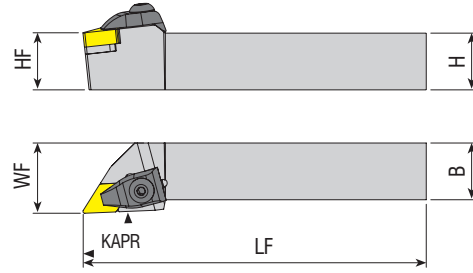
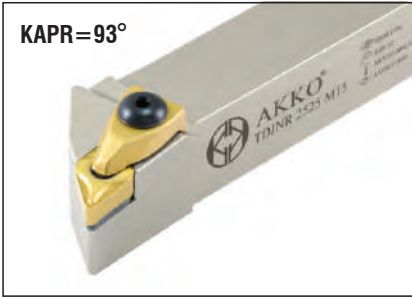

Takım Kodu Ordering Code Bestell-Bezeichnung	Stok Stock Lager		Takım Ölçüleri (mm) Dimension (mm) Abmessung (mm)				Kesici Uç Insert Wendeschneidplatte	Yedek Parçaları / Spare Parts / Ersatzteile						
	R	L	HF=H	B	LF	WF		Baskı Pabuçu Wedge Clamp Spannpratze	Pabuç Vidası Clamp Screw Klemmschraube	Altlık Shim Unterlage	Altlık Vidası Shim Screw Schraube für Unterlage	Segman Ring Feder	Pul Stamp Ring	Anahtar Allen Key Innensechskantschlüssel
TDJNR/L 1616 H11	●	●	16	16	100	20								
TDJNR/L 2020 K11	●	●	20	20	125	25	DN.. 1104..	ATK-01	AKV-01-M5x22	AADN-2-0001	AAV-04-M5x12	-		
TDJNR/L 2525 M11	●	●	25	25	150	32								
TDJNR/L 2020 K15	●	●	20	20	125	25								
TDJNR/L 2525 M15	●	●	25	25	150	32								
TDJNR/L 3232 P15	●	●	32	32	170	40	DN.. 1506..	ATK-02	AKV-30-M6x22	AADN-3-0001	AAV-02-M5x12	AS-01	ABPL-01	AAL-03-3
TDJNR/L 4040 S15	●	●	40	40	250	50								
TDJNR/L 5050 S15	○	○	50	50	250	63								
TDJNR/L 2020 K1504	●	●	20	20	125	25								
TDJNR/L 2525 M1504	●	●	25	25	150	32	DN.. 1504..	ATK-02	AKV-30-M6x22	AADN-2-0003	AAV-02-M5x12	AS-01		
TDJNR/L 3232 P1504	●	●	32	32	170	40								
TDJNR/L 4040 S1504	●	●	40	40	250	50								

R: Sağ / Right / Rechts L: Sol / Left / Links

● Stokta / In Stock / Auf Lager ○ Stokta Yok / Non Stock Item / Kein Lagerartikel, Lieferzeit auf Anfrage

Sipariş Örneği/Ordering Example/Bestellbeispiel  
1 ad./pcs./stück TDHNR 2525 M11



KAPR=93°

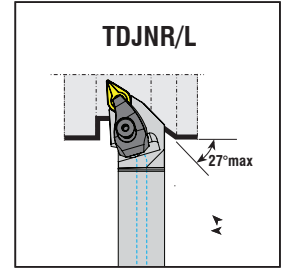
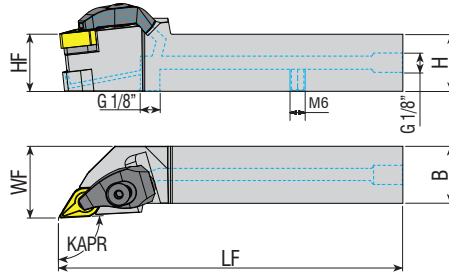

Takım Kodu  
Ordering Code  
Bestell-Bezeichnung

Stok  
Stock  
Lager

Takım Ölçüleri (mm)  
Dimension (mm)  
Abmessung (mm)

Kesici Uç  
Insert  
Wendeschneidplatte

Baskı Pabucu  
Wedge Clamp  
Spannpratze

Pabuç Vidası  
Clamp Screw  
Klemmschraube

Altlık  
Shim  
Unterlage

Altlık Vidası  
Shim Screw  
Schraube für Unterlage

Yay  
Spring  
Feder

Oring  
Ring  
Feder

Sızdırmaz Vida  
Threaded Pin  
Gewindestift

Anahtar  
Allen Key  
Innenschlankschlüssel

Yedek Parçaları / Spare Parts / Ersatzteile

R L

HF=H

B

LF

WF



TDJNR/L 2020 K15-H  
TDJNR/L 2525 M15-H  
TDJNR/L 3232 P15-H

● ●

20

20

125

25

DN.. 1506..

ATKH-01-R

AKV-33-M6x22

AADN-3-0001

AAV-13-M5x8

AKY-01

AXR-01

2705-G1/8x5.5

AAL-03-3

● ●

25

25

150

32

● ●

32

32

170

40

VDI tutucu ile uyumludur. / Compatible with VDI holders. / Kompatibel mit VDI Werkzeughalter.

KAPR=62.5°

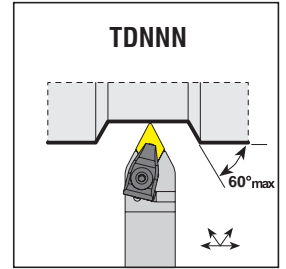
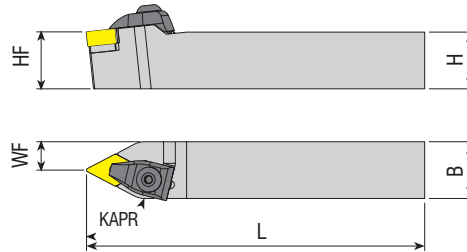

Takım Kodu  
Ordering Code  
Bestell-Bezeichnung

Stok  
Stock  
Lager

Takım Ölçüleri (mm)  
Dimension (mm)  
Abmessung (mm)

Kesici Uç  
Insert  
Wendeschneidplatte

Baskı Pabucu  
Wedge Clamp  
Spannpratze

Pabuç Vidası  
Clamp Screw  
Klemmschraube

Altlık  
Shim  
Unterlage

Altlık Vidası  
Shim Screw  
Schraube für Unterlage

Segman  
Ring  
Feder

Pul Stamp  
Stamp  
Ring

Anahtar  
Allen Key  
Innenschlankschlüssel

Yedek Parçaları / Spare Parts / Ersatzteile

HF=H

B

LF

WF



TDNNN 1616 H11

●

16

16

100

8

TDNNN 2020 K11

●

20

20

125

10

DN.. 1104..

ATK-01

AKV-01-M5x22

AADN-2-0001

AAV-04-M5x12

-

-

-

TDNNN 2525 M11

●

25

25

150

12.5

ABPL-01

AAL-03-3

TDNNN 2020 K15

●

20

20

125

10

TDNNN 2525 M15

●

25

25

150

12.5

TDNNN 3232 P15

●

32

32

170

16

DN.. 1506..

ATK-02

AKV-30-M6x22

AADN-3-0001

AAV-02-M5x12

AS-01

TDNNN 4040 S15

○

40

40

250

20

TDNNN 5050 S15

○

50

50

250

25

R: Sağ / Right / Rechts L: Sol / Left / Links

● Stokta / In Stock / Auf Lager ○ Stokta Yok / Non Stock Item / Kein Lagerartikel, Lieferzeit auf Anfrage

Sipariş Örneği/Ordering Example/Bestellbeispiel

1 ad./pcs./stück TDJNR 2020 K15-H

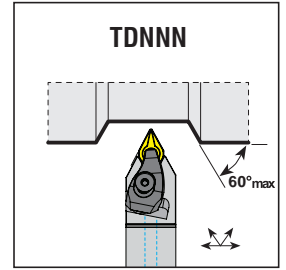
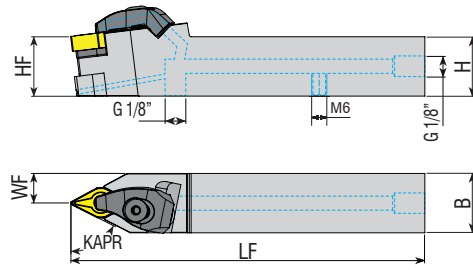

Takım Kodu Ordering Code Bestell-Bezeichnung	Stok Stock Lager	Takım Ölçüleri (mm) Dimension (mm) Abmessung (mm)				Kesici Uç Insert Wendeschneidplatte	Yedek Parçaları / Spare Parts / Ersatzteile							
		HF=H	B	LF	WF		Baskı Pabucu Wedge Clamp Spannpratze	Pabuç Vidası Clamp Screw Klemmschraube	Altlık Shim Unterlage	Altlık Vidası Shim Screw Schraube für Unterlage	Yay Spring Feder	Oring Ring Feder	Sızdırmaz Vida Threaded Pin Gewindestift	Anahtar Allen Key Innensechskantschlüssel
<b>TDNNN 2525 M15-H</b>	●	25	25	150	32									
						<b>DN.. 1506..</b>	ATKH-01-R	AKV-33-M6x22	AADN-3-0001	AAV-13-M5x8	AKY-01	AXR-01	2705-G1,8x5,5	AAL-03-3

VDI tutucu ile uyumludur. / Compatible with VDI holders. / Kompatibel mit VDI Werkzeughalter.

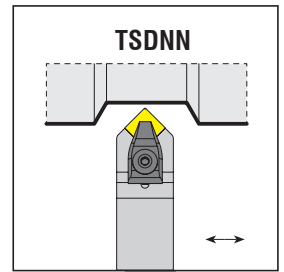
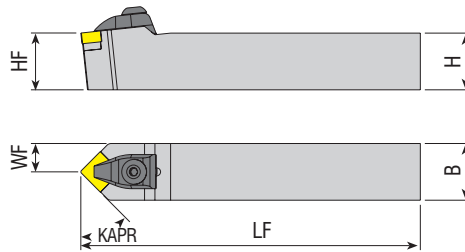

Takım Kodu Ordering Code Bestell-Bezeichnung	Stok Stock Lager	Takım Ölçüleri (mm) Dimension (mm) Abmessung (mm)				Kesici Uç Insert Wendeschneidplatte	Yedek Parçaları / Spare Parts / Ersatzteile							
		HF=H	B	LF	WF		Baskı Pabucu Wedge Clamp Spannpratze	Pabuç Vidası Clamp Screw Klemmschraube	Altlık Shim Unterlage	Altlık Vidası Shim Screw Schraube für Unterlage	Segman Ring Feder	Pul Stamp Ring	Anahtar Allen Key Innensechskantschlüssel	
<b>TSDNN 1616 H12</b>	●	16	16	100	8									
<b>TSDNN 2020 K12</b>	●	20	20	125	10									
<b>TSDNN 2525 M12</b>	●	25	25	150	12.5									
<b>TSDNN 3232 P12</b>	●	32	32	170	16	<b>SN.. 1204..</b>	ATK-02	AKV-30-M6x22	AASN-3-0004	AAV-02-M5x12	AS-01	ABPL-01	AAL-03-3	
<b>TSDNN 2525 M15</b>	○	25	25	150	12.5									
<b>TSDNN 3232 P15</b>	●	32	32	170	16									
<b>TSDNN 4040 S15</b>	○	40	40	250	20									
						<b>SN.. 1506..</b>	ATK-04	AKV-19-M7x25	AASN-3-0023	AAV-05-M6x15	AS-02	ABPL-02	AAL-05-4	

R: Sağ / Right / Rechts L: Sol / Left / Links

● Stokta / In Stock / Auf Lager ○ Stokta Yok / Non Stock Item / Kein Lagerartikel, Lieferzeit auf Anfrage

Sipariş Örneği/Ordering Example/Bestellbeispiel

1 ad./pcs./stück TDNNN 2525 M15-H



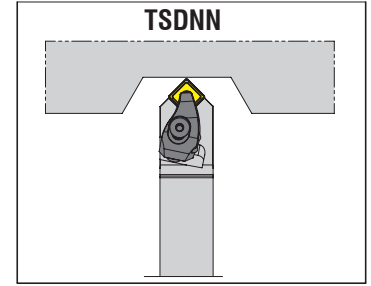
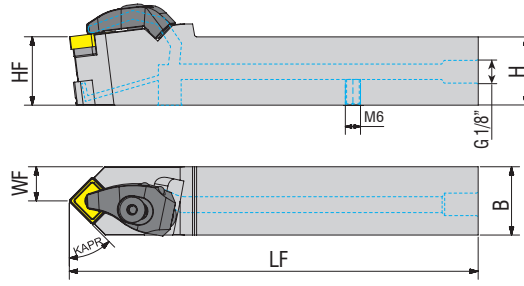

Takım Kodu Ordering Code Bestell-Bezeichnung	Stok Stock Lager	Takım Ölçüleri (mm) Dimension (mm) Abmessung (mm)				Kesici Uç Insert Wendeschneidplatte	Yedek Parçaları / Spare Parts / Ersatzteile									
		HF=H	B	LF	WF		Baskı Pabuçu Wedge Clamp Spannpratze	Pabuç Vidası Clamp Screw Klemmschraube	Altlık Shim Unterlage	Altlık Vidası Shim Screw Schraube für Unterlage	Yay Spring Feder	Oring Ring Feder	Sızdırmaz Vida Threaded Pin Gewindestift	Anahtar Allen Key Innenschlitzschlüssel		
TSDNN 2525 M12-H	○	25	25	150	25	SN.. 1204..	ATKH-01-R	AKV-33-M6x22	AASN-3-0004	AAV-02-M5x12			2705-G1/8x5.5	AAL-03-3		
TSDNN 3232 P12-H	○	32	32	170	16		ATKH-02-L									
TSDNN 2525 M15-H	○	25	25	150	12.7	SN.. 1506..	ATKH-07-R	AKV-39-M7x21	AASN-3-0023	AAV-05-M6x10	AKY-01	AXR-01	2705-G1/8x5.5	AAL-05-4		
TSDNN 3232 P15-H	○	32	32	170	16		ATKH-08-L									
TSDNN 4040 S15-H	○	40	40	250	20											

VDI tutucu ile uyumludur. / Compatible with VDI holders. / Kompatibel mit VDI Werkzeughalter.

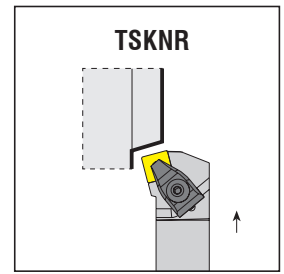
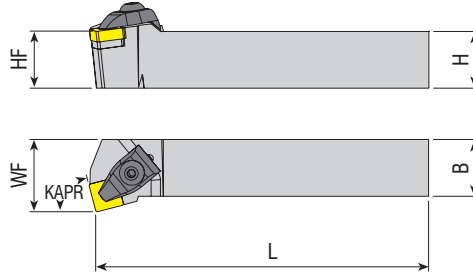

Takım Kodu Ordering Code Bestell-Bezeichnung	Stok Stock Lager		Takım Ölçüleri (mm) Dimension (mm) Abmessung (mm)				Kesici Uç Insert Wendeschneidplatte	Yedek Parçaları / Spare Parts / Ersatzteile									
	R	L	HF=H	B	LF	WF		Baskı Pabuçu Wedge Clamp Spannpratze	Pabuç Vidası Clamp Screw Klemmschraube	Altlık Shim Unterlage	Altlık Vidası Shim Screw Schraube für Unterlage	Segman Ring Feder	Pul Stamp Ring	Anahtar Allen Key Innenschlitzschlüssel			
TSKNR/L 2020 K12	●	●	20	20	125	25	SN.. 1204..	ATK-02	AKV-30-M6x22	AASN-3-0004	AAV-02-M5x12	AS-01	ABPL-01	AAL-03-3			
TSKNR/L 2525 M12	●	●	25	25	150	32		ATK-04	AKV-19-M7x25	AASN-3-0023	AAV-05-M6x15	AS-02	ABPL-02	AAL-05-4			
TSKNR/L 3232 P12	●	●	32	32	170	40											
TSKNR/L 3232 P15	●	●	32	32	170	40											

R: Sağ / Right / Rechts L: Sol / Left / Links

● Stokta / In Stock / Auf Lager ○ Stokta Yok / Non Stock Item / Kein Lagerartikel, Lieferzeit auf Anfrage

Sipariş Örneği/Ordering Example/Bestellbeispiel

1 ad./pcs./stück TSDNN 2525 M12-H

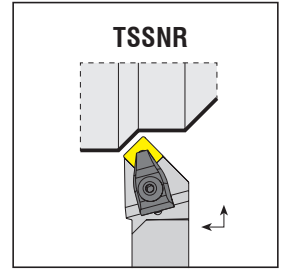
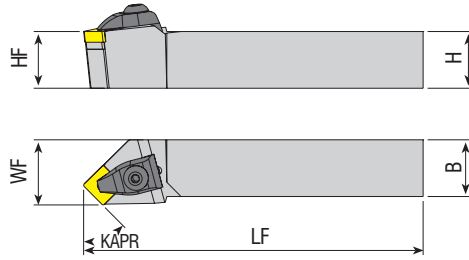

Takım Kodu Ordering Code Bestell-Bezeichnung	Stok Stock Lager		Takım Ölçüleri (mm) Dimension (mm) Abmessung (mm)				Kesici Uç Insert Wendeschneidplatte	Yedek Parçaları / Spare Parts / Ersatzteile							
	R	L	HF=H	B	LF	WF		Baskı Pabucu Wedge Clamp Spannpratze	Pabuç Vidası Clamp Screw Klemmschraube	Altlık Shim Unterlage	Altlık Vidası Shim Screw Schraube für Unterlage	Segman Ring Feder	Pul Stamp Ring	Anahtar Allen Key Innensechskantschlüssel	
TSSNR/L 2020 K12	●	●	20	20	125	25	SN.. 1204..	ATK-02	AKV-30-M6x22	AASN-3-0004	AAV-02-M5x12	AS-01	ABPL-01	AAL-03-3	
TSSNR/L 2525 M12	●	●	25	25	150	32									
TSSNR/L 3232 P12	●	●	32	32	170	40									
TSSNR/L 2525 M15	●	●	25	25	150	32	SN.. 1506..	ATK-04	AKV-19-M7x25	AASN-3-0023	AAV-05-M6x15	AS-02	ABPL-02	AAL-05-4	
TSSNR/L 3232 P15	●	●	32	32	170	40									

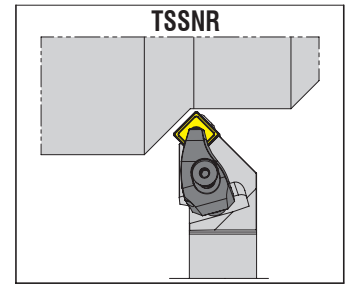
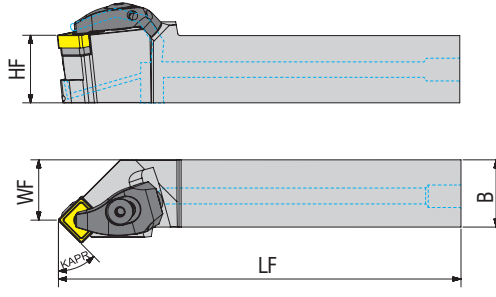

Takım Kodu Ordering Code Bestell-Bezeichnung	Stok Stock Lager		Takım Ölçüleri (mm) Dimension (mm) Abmessung (mm)				Kesici Uç Insert Wendeschneidplatte	Yedek Parçaları / Spare Parts / Ersatzteile								
	R	L	HF=H	B	LF	WF		Baskı Pabucu Wedge Clamp Spannpratze	Pabuç Vidası Clamp Screw Klemmschraube	Altlık Shim Unterlage	Altlık Vidası Shim Screw Schraube für Unterlage	Yay Spring Feder	Oring Ring Feder	Sızdırmaz Vida Threaded Pin Gewindestift	Anahtar Allen Key Innensechskantschlüssel	
TSSNR/L 2525 M12-H	○	○	25	25	150	32	SN.. 1204..	ATKH-01-R ATKH-02-L	AKV-33-M6x22	AASN-3-0004	AAV-02-M5x12				AAL-03-3	
TSSNR/L 3232 P12-H	○	○	32	32	170	32										
TSSNR/L 2525 M15-H	○	○	25	25	150	40										
TSSNR/L 3232 P15-H	○	○	32	32	170	40	SN.. 1506..	ATKH-07-R ATKH-08-L	AKV-39-M7x21	AASN-3-0023	AAV-05-M6x10	AKY-01	AXR-01	2705-G1/8x5.5	AAL-05-4	
TSSNR/L 4040 S15-H	○	○	40	40	250	50										

R: Sağ / Right / Rechts L: Sol / Left / Links

● Stokta / In Stock / Auf Lager ○ Stokta Yok / Non Stock Item / Kein Lagerartikel, Lieferzeit auf Anfrage

VDI tutucu ile uyumludur. / Compatible with VDI holders. / Kompatibel mit VDI Werkzeughalter.

Sağ takımlarda sol baskı pabucu, sol takımlarda sağ baskı pabucu kullanılmalıdır.

The left wedge clamp should be used on right-hand tools, and the right wedge clamp should be used on left-hand tools.

Die linke Spannpratze für rechte Werkzeuge und die rechte Spannpratze für linke Werkzeuge verwendet werden.

Sipariş Örneği/Ordering Example/Bestellbeispiel

1 ad./pcs./stück TSSNR 2020 K12

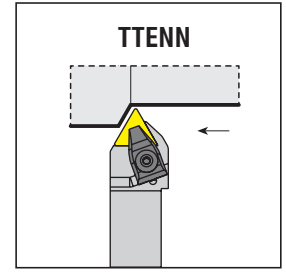
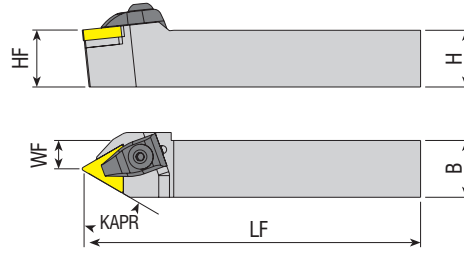

Takım Kodu Ordering Code Bestell-Bezeichnung	Stok Stock Lager		Takım Ölçüleri (mm) Dimension (mm) Abmessung (mm)				Kesici Uç Insert Wendeschneidplatte	Yedek Parçaları / Spare Parts / Ersatzteile						
	R	L	HF=H	B	LF	WF		Baskı Pabucu Wedge Clamp Spannpratze	Pabuç Vidası Clamp Screw Klemmschraube	Altlık Shim Unterlage	Altlık Vidası Shim Screw Schraube für Unterlage	Segman Ring Feder	Pul Stamp Ring	Anahtar Allen Key Inmenschenschlüssel
TTENN 2020 K16	●		20	20	125	10	TN.. 1604..					-	ABPL-01	AAL-03-3
TTENN 2525 M16	●		25	25	150	12.5								
TTENN 3232 P16	●		32	32	170	16								
TTENN 2525 M22	●		25	25	150	12.5	TN.. 2204...					AS-01	ABPL-01	AAL-03-3
TTENN 3232 P22	●		32	32	170	16								
TTENN 4040 S22	○		40	40	250	20								

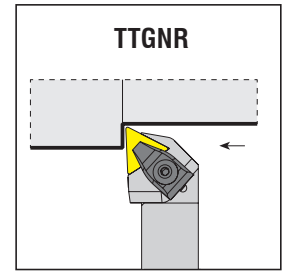
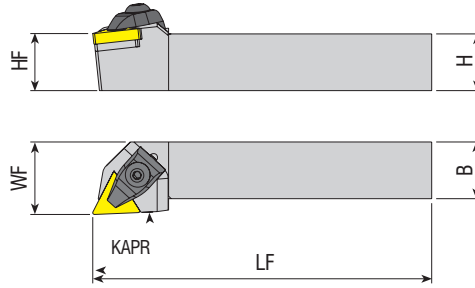
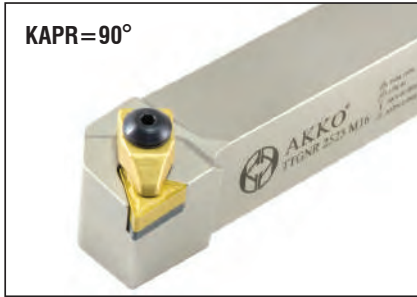

Takım Kodu Ordering Code Bestell-Bezeichnung	Stok Stock Lager		Takım Ölçüleri (mm) Dimension (mm) Abmessung (mm)				Kesici Uç Insert Wendeschneidplatte	Yedek Parçaları / Spare Parts / Ersatzteile						
	R	L	HF=H	B	LF	WF		Baskı Pabucu Wedge Clamp Spannpratze	Pabuç Vidası Clamp Screw Klemmschraube	Altlık Shim Unterlage	Altlık Vidası Shim Screw Schraube für Unterlage	Segman Ring Feder	Pul Stamp Ring	Anahtar Allen Key Inmenschenschlüssel
TTGNR/L 2020 K16	●	●	20	20	125	25	TN.. 1604..					-	ABPL-01	AAL-03-3
TTGNR/L 2525 M16	●	●	25	25	150	32								
TTGNR/L 3232 P16	●	●	32	32	170	40								
TTGNR/L 2525 M22	●	●	25	25	150	32	TN.. 2204...					AS-01	ABPL-01	AAL-03-3
TTGNR/L 3232 P22	●	●	32	32	170	40								
TTGNR/L 4040 S22	●	○	40	40	250	50								

R: Sağ / Right / Rechts L: Sol / Left / Links

● Stokta / In Stock / Auf Lager ○ Stokta Yok / Non Stock Item / Kein Lagerartikel, Lieferzeit auf Anfrage

Sipariş Örneği/Ordering Example/Bestellbeispiel

1 ad./pcs./stück TTENN 2020 K16

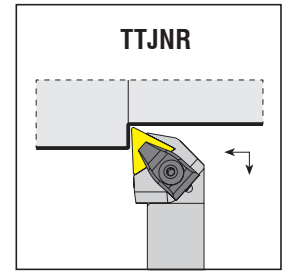
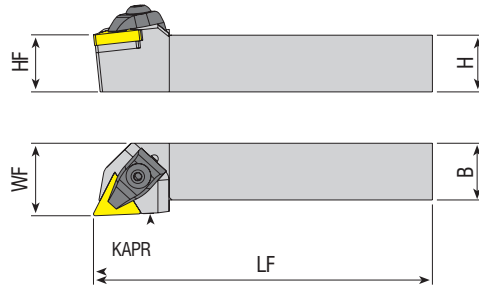
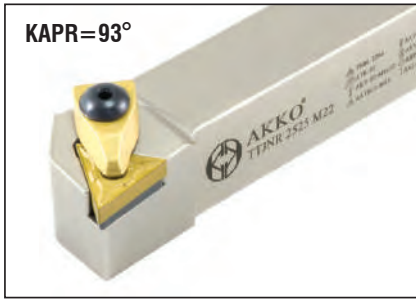

Takım Kodu Ordering Code Bestell-Bezeichnung	Stok Stock Lager		Takım Ölçüleri (mm) Dimension (mm) Abmessung (mm)				Kesici Uç Insert Wendeschneidplatte	Yedek Parçaları / Spare Parts / Ersatzteile							
	R	L	HF=H	B	LF	WF		Baskı Pabucu Wedge Clamp Spannpratze	Pabuç Vidası Clamp Screw Klemmschraube	Altlık Shim Unterlage	Altlık Vidası Shim Screw Schraube für Unterlage	Segman Ring Feder	Pul Stamp Ring	Anahtar Allen Key Innensechskantschlüssel	
TTJNR/L 2020 K16	●	●	20	20	125	25	TN.. 1604..	ATK-01	AKV-01-M5x22	AATN-2-0002	AAV-03-M5x12	-	ABPL-01	AAL-03-3	
TTJNR/L 2525 M16	●	●	25	25	150	32									
TTJNR/L 3232 P16	●	●	32	32	170	40									
TTJNR/L 2525 M22	●	●	25	25	150	32	TN.. 2204...	ATK-02	AKV-30-M6x22	AATN-3-0015	AAV-02-M5x12	AS-01	ABPL-01	AAL-03-3	
TTJNR/L 3232 P22	●	●	32	32	170	40									
TTJNR/L 4040 S22	○	○	40	40	250	50									

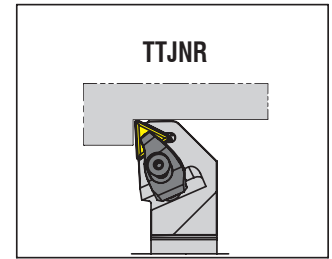
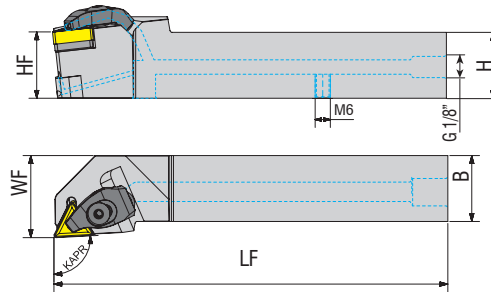

Takım Kodu Ordering Code Bestell-Bezeichnung	Stok Stock Lager		Takım Ölçüleri (mm) Dimension (mm) Abmessung (mm)				Kesici Uç Insert Wendeschneidplatte	Yedek Parçaları / Spare Parts / Ersatzteile							
	R	L	HF=H	B	LF	WF		Baskı Pabucu Wedge Clamp Spannpratze	Pabuç Vidası Clamp Screw Klemmschraube	Altlık Shim Unterlage	Altlık Vidası Shim Screw Schraube für Unterlage	Yay Spring Feder	Oring Ring Feder	Sızdırmaz Vida Threaded Pin Gewindestift	Anahtar Allen Key Innensechskantschlüssel
TTJNR/L 2525 M16-H	○	○	25	25	150	32	TN.. 1604..	ATKH-03-R	AKV-37-M5x18	AATN-2-0002	AAV-03-M5x12	AKY-02	AXR-02	2705-G1/8x5.5	AAL-02-2.5
TTJNR/L 3232 P16-H	○	○	32	32	170	32		ATKH-04-L							
TTJNR/L 2525 M22-H	○	○	25	25	150	40	TN.. 2204...	ATKH-01-R	AKV-33-M6x22	AATN-3-0015	AAV-02-M5x12	AKY-01	AXR-01	AAL-03-3	
TTJNR/L 3232 P22-H	○	○	32	32	170	40		ATKH-02-L							

R: Sağ / Right / Rechts L: Sol / Left / Links

● Stokta / In Stock / Auf Lager ○ Stokta Yok / Non Stock Item / Kein Lagerartikel, Lieferzeit auf Anfrage

VDI tutucu ile uyumludur. / Compatible with VDI holders. / Kompatibel mit VDI Werkzeughalter.

Sipariş Örneği/Ordering Example/Bestellbeispiel

1 ad./pcs./stück TTJNR 2020 K16

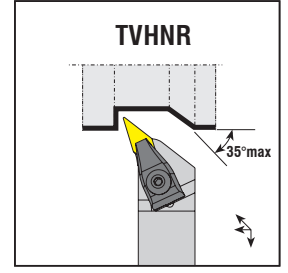
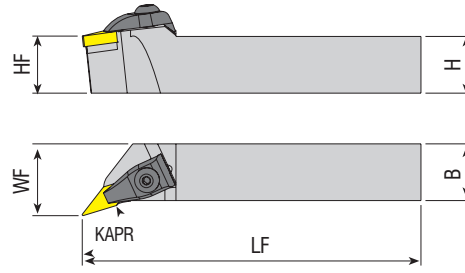

Takım Kodu Ordering Code Bestell-Bezeichnung	Stok Stock Lager		Takım Ölçüleri (mm) Dimension (mm) Abmessung (mm)				Kesici Uç Insert Wendeschneidplatte	Baskı Pabucu Wedge Clamp Spannpratze	Pabuç Vidası Clamp Screw Klemmschraube	Altlık Shim Unterlage	Altlık Vidası Shim Screw Schraube für Unterlage	Segman Ring Feder	Pul Stamp Ring	Anahtar Allen Key Innensechskantschlüssel
	R	L	HF=H	B	LF	WF								
TVHNR/L 2020 K16	●	●	20	20	125	25	VN.. 1604..	ATK-03	AKV-30-M6x22	AAVN-2-0002	AAV-04-M5x12	AS-01	ABPL-01	AAL-03-3
TVHNR/L 2525 M16	●	●	25	25	150	32								
TVHNR/L 3232 P16	●	●	32	32	170	40								

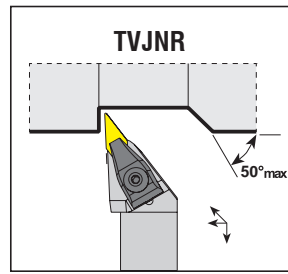
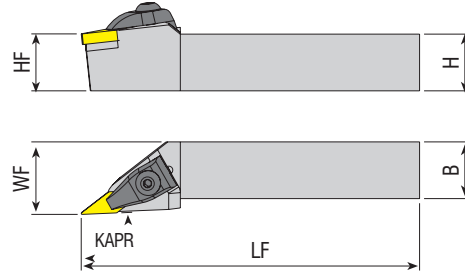

Takım Kodu Ordering Code Bestell-Bezeichnung	Stok Stock Lager		Takım Ölçüleri (mm) Dimension (mm) Abmessung (mm)				Kesici Uç Insert Wendeschneidplatte	Baskı Pabucu Wedge Clamp Spannpratze	Pabuç Vidası Clamp Screw Klemmschraube	Altlık Shim Unterlage	Altlık Vidası Shim Screw Schraube für Unterlage	Segman Ring Feder	Pul Stamp Ring	Anahtar Allen Key Innensechskantschlüssel
	R	L	HF=H	B	LF	WF								
TVJNR/L 2020 K16	●	●	20	20	125	25	VN.. 1604..	ATK-03	AKV-30-M6x22	AAVN-2-0002	AAV-04-M5x12	AS-01	ABPL-01	AAL-03-3
TVJNR/L 2525 M16	●	●	25	25	150	32								
TVJNR/L 3232 P16	●	●	32	32	170	40								

R: Sağ / Right / Rechts L: Sol / Left / Links

● Stokta / In Stock / Auf Lager ○ Stokta Yok / Non Stock Item / Kein Lagerartikel, Lieferzeit auf Anfrage

Sipariş Örneği/Ordering Example/Bestellbeispiel

1 ad./pcs./stück TVHNR 2020 K16

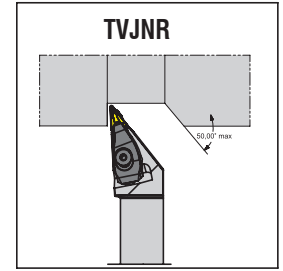
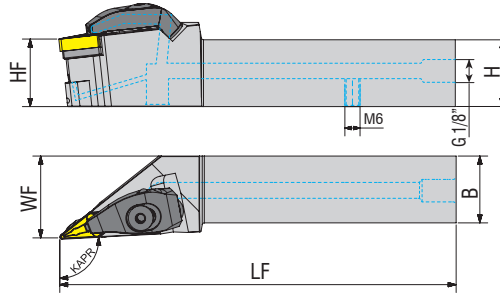

Takım Kodu Ordering Code Bestell-Bezeichnung	Stok Stock Lager		Takım Ölçüleri (mm) Dimension (mm) Abmessung (mm)				Kesici Uç Insert Wendeschneidplatte	Yedek Parçaları / Spare Parts / Ersatzteile															
	R	L	HF=H	B	LF	WF		Baskı Pabucu Wedge Clamp Spannpratze	Pabuç Vidası Clamp Screw Klemmschraube	Altlık Shim Unterlage	Altlık Vidası Shim Screw Schraube für Unterlage	Yay Spring Feder	Oring Ring Feder	Sızdırmaz Vidı Threaded Pin Gewindestift	Anahtar Allen Key Innensechskantschlüssel								
TVJNR/L 2020 K16-H	○	○	20	20	125	25	VN.. 1604..																
TVJNR/L 2525 M16-H	○	○	25	25	150	32										ATKH-05-R	AKV-33-M6x22	AAVN-2-0002	AAV-04-M5x12	AKY-01	AXR-01	2705-G1/8x5.5	AAL-03-3
TVJNR/L 3232 P16-H	○	○	32	32	170	40										ATKH-06-L							

VDI tutucu ile uyumludur. / Compatible with VDI holders. / Kompatibel mit VDI Werkzeughalter.

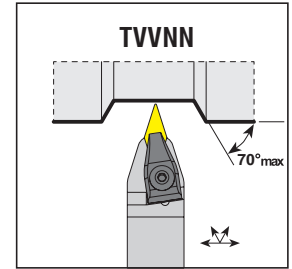
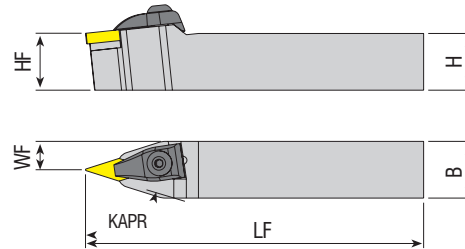

Takım Kodu Ordering Code Bestell-Bezeichnung	Stok Stock Lager		Takım Ölçüleri (mm) Dimension (mm) Abmessung (mm)				Kesici Uç Insert Wendeschneidplatte	Yedek Parçaları / Spare Parts / Ersatzteile													
			HF=H	B	LF	WF		Baskı Pabucu Wedge Clamp Spannpratze	Pabuç Vidası Clamp Screw Klemmschraube	Altlık Shim Unterlage	Altlık Vidası Shim Screw Schraube für Unterlage	Segman Ring Feder	Pul Stamp Ring	Anahtar Allen Key Innensechskantschlüssel							
TVVNN 2020 K16	●		20	20	125	10	VN.. 1604..														
TVVNN 2525 M16	●		25	25	150	12.5									ATK-03	AKV-30-M6x22	AAVN-2-0002	AAV-04-M5x12	AS-01	ABPL-01	AAL-03-3
TVVNN 3232 P16	●		32	32	170	16															

R: Sağ / Right / Rechts L: Sol / Left / Links

● Stokta / In Stock / Auf Lager ○ Stokta Yok / Non Stock Item / Kein Lagerartikel, Lieferzeit auf Anfrage

Sipariş Örneği/Ordering Example/Bestellbeispiel

1 ad./pcs./stück TVJNR 2020 K16-H

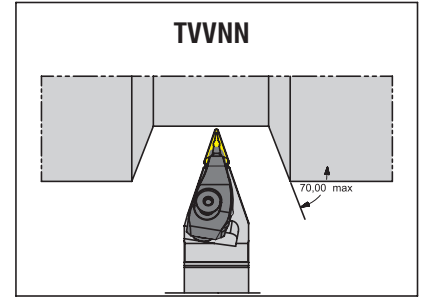
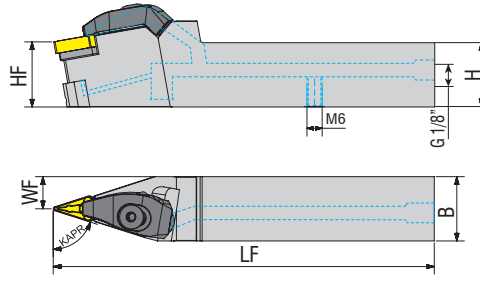

Takım Kodu Ordering Code Bestell-Bezeichnung	Stok Stock Lager	Takım Ölçüleri (mm) Dimension (mm) Abmessung (mm)				Kesici Uç Insert Wendeschneidplatte	Yedek Parçaları / Spare Parts / Ersatzteile							
		HF=H	B	LF	WF		Baskı Pabucu Wedge Clamp Spannpratze	Pabuç Vidası Clamp Screw Klemmschraube	Altlık Shim Unterlage	Altlık Vidası Shim Screw Schraube für Unterlage	Yay Spring Feder	Oring Ring Feder	Sızdırmaz Vida Threaded Pin Gewindestift	Anahtar Allen Key Innensechskantschlüssel
TVVNN 2020 K16-H	○	20	20	125	10	VN.. 1604..	ATKH-05-R ATKH-06-L	AKV-33-M6x22	AAVN-2-0002	AAV-04-M5x12	AKY-01	AXR-01	2705-G1/8x5.5	AAL-03-3
TVVNN 2525 M16-H	○	25	25	150	12.7									

VDI tutucu ile uyumludur. / Compatible with VDI holders. / Kompatibel mit VDI Werkzeughalter.

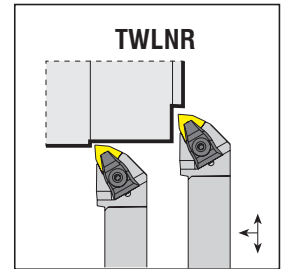
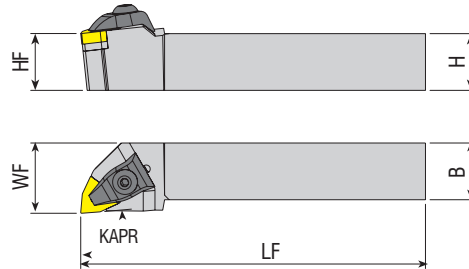

Takım Kodu Ordering Code Bestell-Bezeichnung	Stok Stock Lager		Takım Ölçüleri (mm) Dimension (mm) Abmessung (mm)				Kesici Uç Insert Wendeschneidplatte	Yedek Parçaları / Spare Parts / Ersatzteile							
	R	L	HF=H	B	LF	WF		Baskı Pabucu Wedge Clamp Spannpratze	Pabuç Vidası Clamp Screw Klemmschraube	Altlık Shim Unterlage	Altlık Vidası Shim Screw Schraube für Unterlage	Segman Ring Feder	Pul Stamp Ring	Anahtar Allen Key Innensechskantschlüssel	
TWLNR/L 1616 H06	●	●	16	16	100	20	WN.. 0604..	ATK-01	AKV-01-M5x22	AAVN-SW317	AAV-01-M3x10	-	ABPL-01	AAL-03-3	
TWLNR/L 2020 K06	●	●	20	20	125	25									
TWLNR/L 2525 M06	●	●	25	25	150	32									
TWLNR/L 2020 K08	●	●	20	20	125	25	WN.. 0804..	ATK-02	AKV-30-M6x22	AAVN-3-0001	AAV-02-M5x12	AS-01	ABPL-01	AAL-03-3	
TWLNR/L 2525 M08	●	●	25	25	150	32									
TWLNR/L 3232 P08	●	●	32	32	170	40									
TWLNR/L 4040 S08	●	●	40	40	250	50									
TWLNR/L 5050 S08	○	○	50	50	250	60									

R: Sağ / Right / Rechts L: Sol / Left / Links

● Stokta / In Stock / Auf Lager ○ Stokta Yok / Non Stock Item / Kein Lagerartikel, Lieferzeit auf Anfrage

Sipariş Örneği/Ordering Example/Bestellbeispiel

1 ad./pcs./stück TVVNN 2020 K16-H

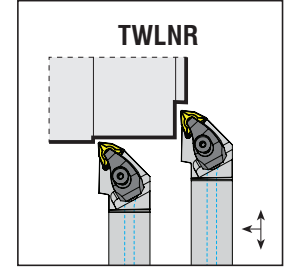
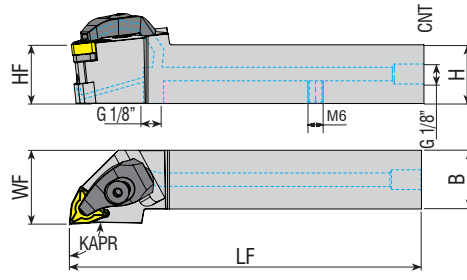

**Takım Kodu**  
**Ordering Code**  
*Bestell-Bezeichnung*

Stok Stock Lager		Takım Ölçüleri (mm) Dimension (mm) Abmessung (mm)					Kesici Uç Insert Wendeschneidplatte	Yedek Parçaları / Spare Parts / Ersatzteile									
								Baskı Pabuçlu Wedge Clamp Spannpratze	Pabuç Vidası Clamp Screw Klemmschraube	Altlık Shim Unterlage	Altlık Vidası Shim Screw Schraube für Unterlage	Yay Spring Feder	Oring Ring Feder	Sızdırmaz Vida Threaded Pin Gewindestift	Anahtar Allen Key Innensechskantschlüssel		
R	L	HF=H	B	LF	WF												
●	●	20	20	125	25												
●	●	25	25	150	32	WN.. 0604..	ATKH-03-R	-	AAWN-SW317	AAV-01-M3X10	AKY-03	AXR-02				AXR-02	
●	●	32	32	170	40								2705-G1/8x5.5				
●	●	20	20	125	25												
●	●	25	25	150	32	WN.. 0804..	ATKH-01-R	AKV-33-M6x22	AAWN-3-0001	AAV-13-M5x8	AKY-01	AXR-01				AAL-03-3	
●	●	32	32	170	40												

R: Sağ / Right / Rechts L: Sol / Left / Links

● Stokta / In Stock / Auf Lager ○ Stokta Yok / Non Stock Item / Kein Lagerartikel, Lieferzeit auf Anfrage  
VDI tutucu ile uyumludur. / Compatible with VDI holders. / Kompatibel mit VDI Werkzeughalter.

Sipariş Örneği/Ordering Example/Bestellbeispiel  
1 ad./pcs./stück TWLNR 2020 K06-H





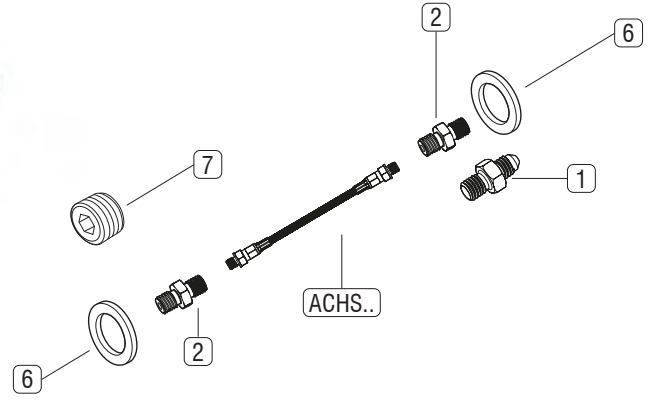
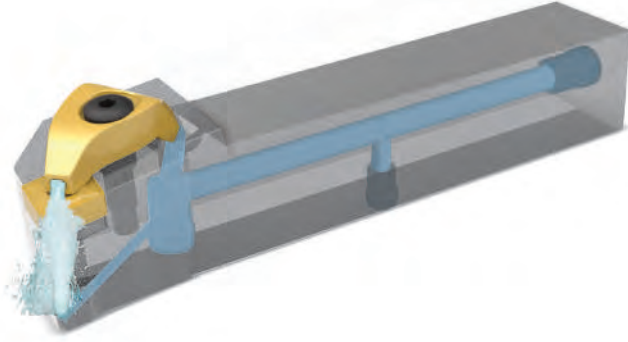

Not: İçten soğutmalı tüm torna katerlerinde kullanılabilecek 3 tip soğutma hortum setleri tasarlanmıştır. Takımların kullanılmasından önce, kullanılmayan bağlantıların set içindeki vida ile kapatılarak sızdırmazlığın sağlanmasına dikkat edilmelidir. Torna katerlerine yönelik soğutma hortum setleri, ACHS... 10 bar ile maksimum 150 bar basınç aralığında kullanılabilir.

Note: 3 types of cooling hose sets are designed that can be used in all internally cooled lathes. Before using the tools, care should be taken to ensure that the unused connections are closed with the screw in the set and that sealing is ensured. Cooling hose sets for lathe tools can be used in the pressure range of ACHS ... 10 bar to max 150 bar.

Notiz: Es wurden 3 Arten von Kühlschlauch-Sets entwickelt, die in allen intern gekühlten Drehmaschinen verwendet werden können. Vor der Verwendung der Werkzeuge sollte darauf geachtet werden, dass die nicht verwendeten Verbindungen mit der Schraube im Satz geschlossen werden und die Abdichtung gewährleistet ist. Kühlschlauchsätze für Drehmaschinen können im Druckbereich von ACHS ... 10 bar bis max. 150 bar eingesetzt werden.

Set İçindeki Parçalar Parts In The Set Teile im Set				Uzunluk / Length Code / Länge		
				Set Kodu: Set Code: Code Einstellen: ACHS-1-250	Set Kodu: Set Code: Code Einstellen: ACHS-2-250	Set Kodu: Set Code: Code Einstellen: ACHS-3-250
1		AMP-01	M10 Bağlantı Elemanı M10 Fastener M10 Verschluss	1x	-	-
2		AMP-02	G 1/8" Çift Bağlantı Elemanı G 1/8" Double Fastener G 1/8" Doppelverschluss	2x	1x	-
3		AMP-03	G 1/8" Açılı Bağlantısı G 1/8" Angle Connection G 1/8" Winkelverbindung	-	1x	2x
4		AMP-04	M10" Açılı Bağlantısı M10" Angle Connection M10" Winkelverbindung	-	1x	1x
5		AMP-05	G1/4"-G1/8" Kısılma Parçası G1/4"-G1/8" Capillary Piece G1/4"-G1/8" Kapillarstück	-	1x	1x
6		AG-01	Bakır Conta Copper Gasket Kupferdichtung	2x	3x	4x
7		2705-G1/8-5.5	G1/8" Sızdırmaz Civata G1/8" Sealing Bolt G1/8" Dichtungsschraube	1x	1x	1x
8		AH-1-250	Hortum Hose Schlauch	1x	-	-
9		AH-2-250	Hortum Hose Schlauch	-	1x	-
10		AH-3-250	Hortum Hose Schlauch	-	-	1x